

Existing Shed Front
1 : 100

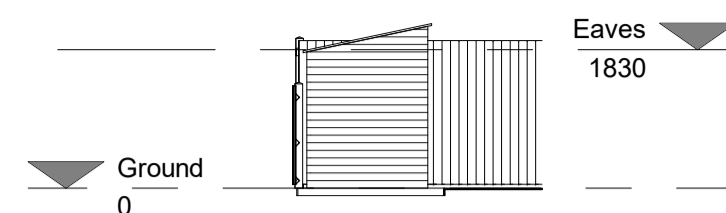

Elevation Shed L Side
1 : 100

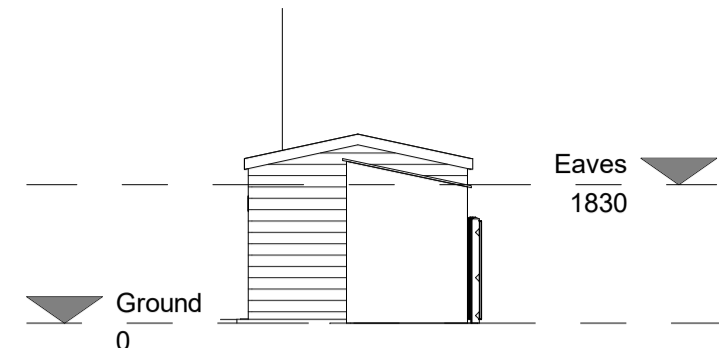

Elevation Shed R Side
1 : 100

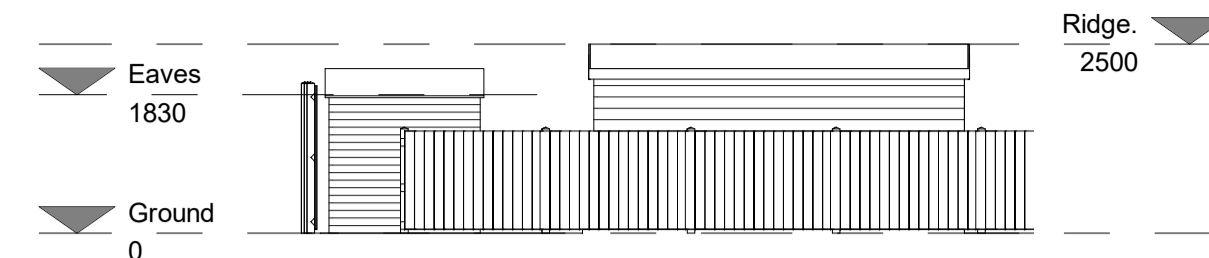

Elevation Shed Rear
1 : 100

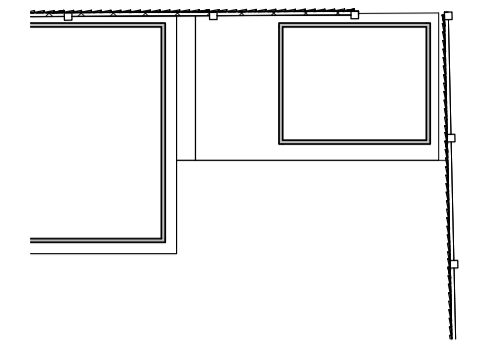

Ground Existing Shed
1 : 100



Elevation Pod Front
1 : 100

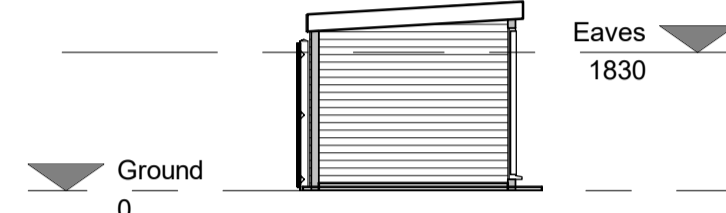

Proposed L Side Elevation Pod
1 : 100

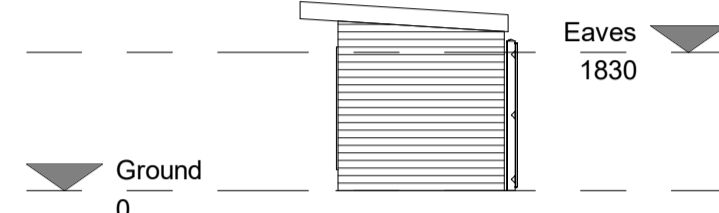

Proposed R Side Elevation Pod
1 : 100

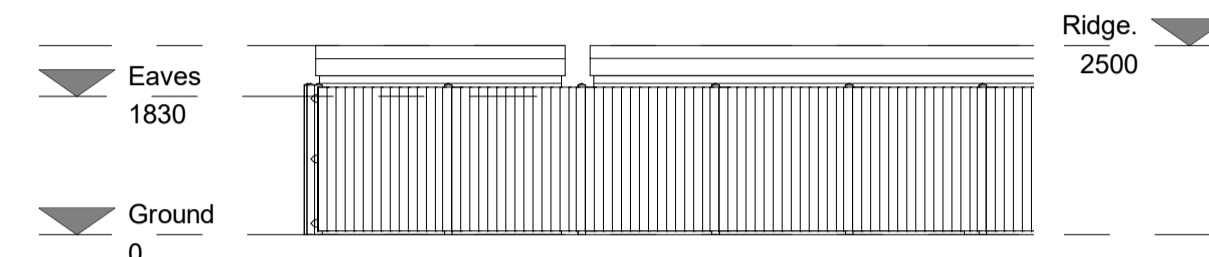

Proposed Rear Elevation Pod
1 : 100

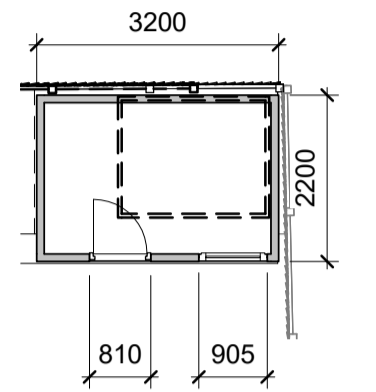

Ground Proposed Pod
1 : 100

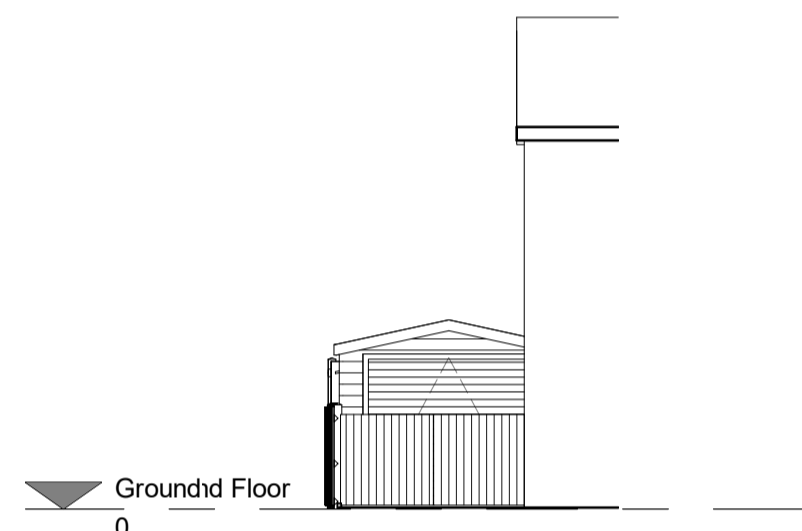

Existing Gates
1 : 100

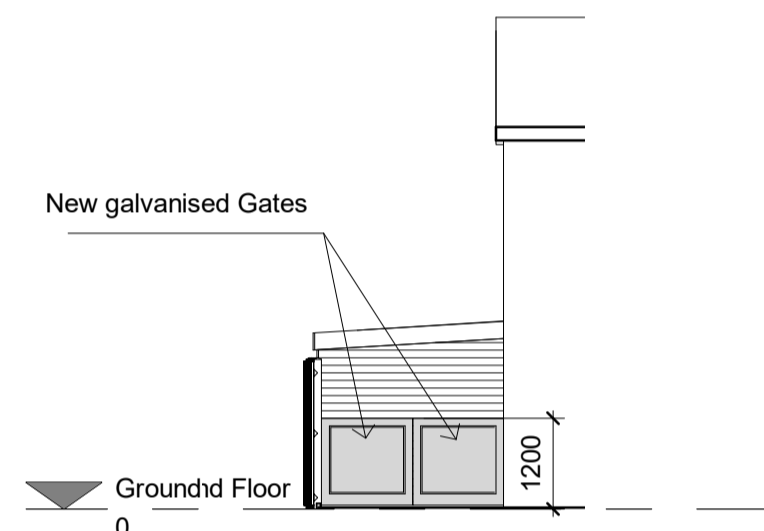

Proposed Gates
1 : 100

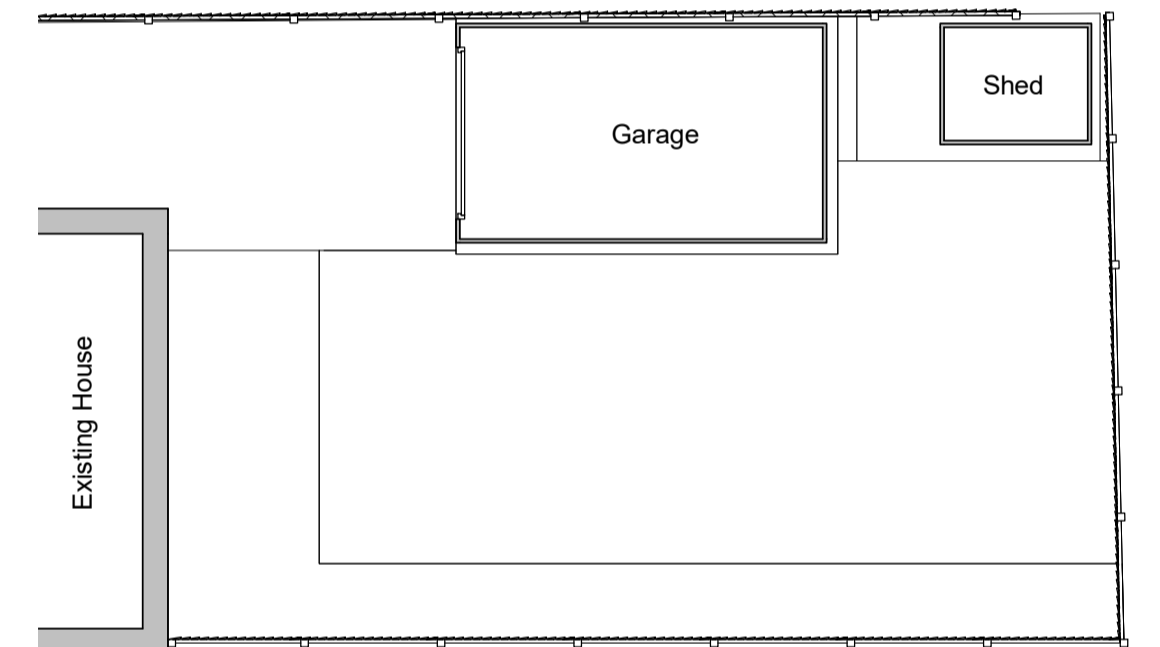

Ground Existing Garage
1 : 100

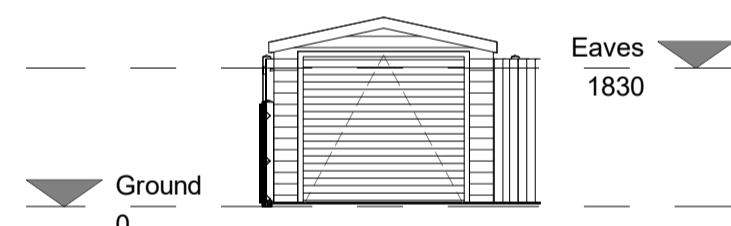

Elevation Garage Front
1 : 100

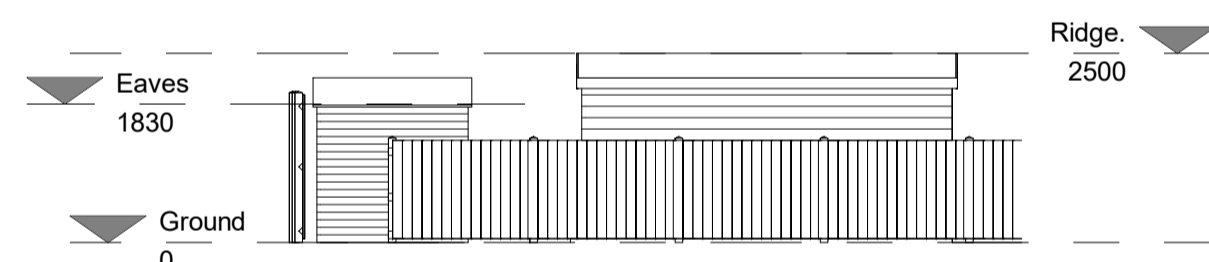

Elevation Garage L Side
1 : 100

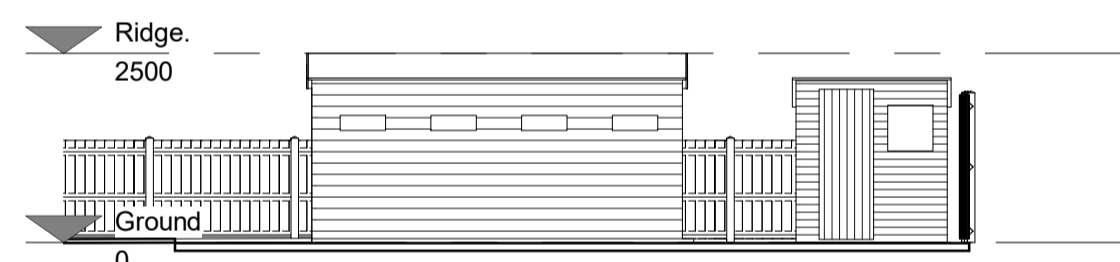

Elevation Garage R Side
1 : 100

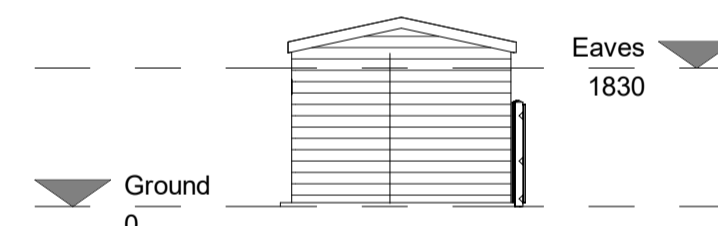

Elevation Garage Rear
1 : 100

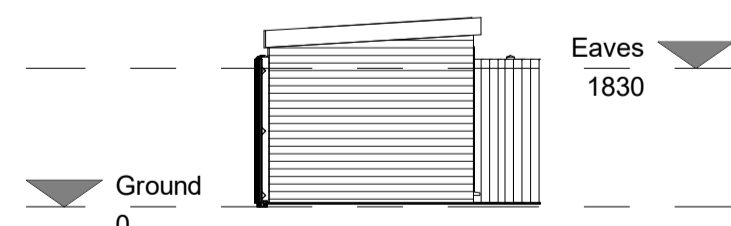

Elevation Proposed Annex
1 : 100

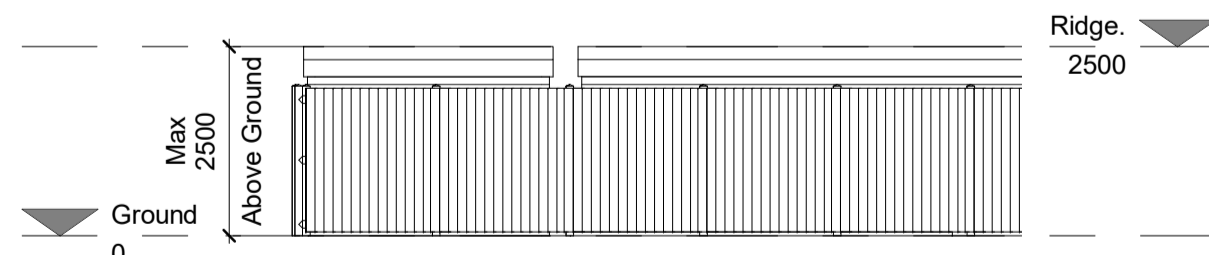

Elevation Proposed L Side Annex
1 : 100

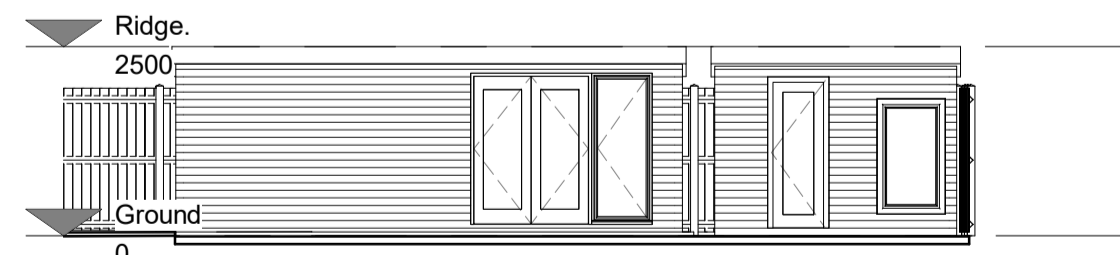

Elevation Proposed R Side Annex
1 : 100

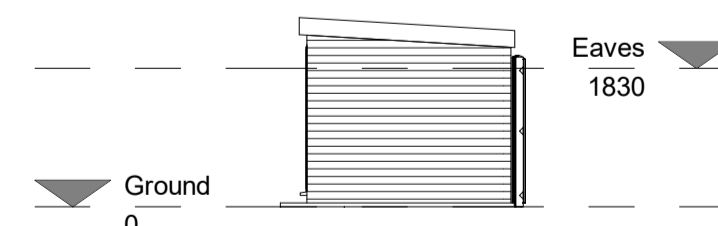

Elevation Proposed Rear Annex
1 : 100

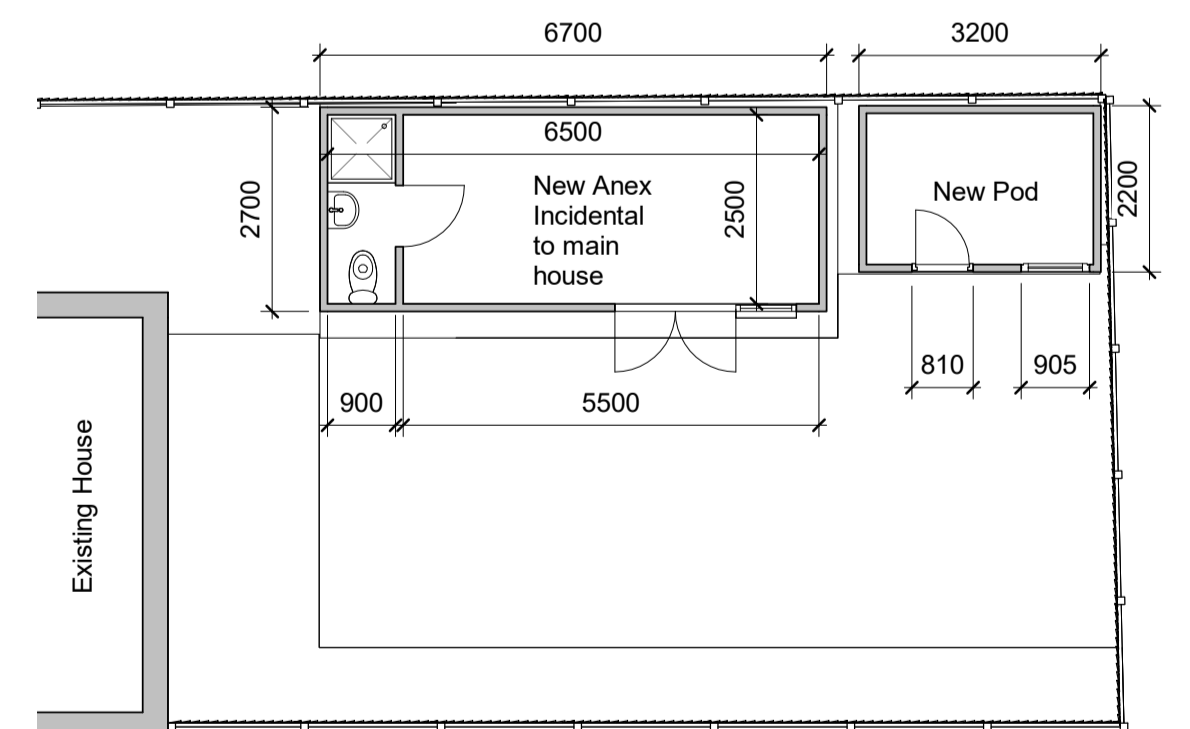

Ground Proposed Annex
1 : 100

©Copyright
All Drawings Are Copyrighted under Law and will only be licensed once payment has been received in full. ©Copyright to all drawings is retained by SMARTePLANS®
Party Wall Act 1996: Party wall agreements are the responsibility of the client.
Drawing is for planning purposes only, not construction. Check that this drawing is the latest/final revision, if in doubt, ask. Any dimensions shown are subject to site surveys and all measurements are to be checked on site prior to any construction or manufacture.
All dimensions are in millimetres unless stated otherwise. No dimensions to be scaled from drawings. Specific details are subject to further design development. This drawing is copyright protected. Drawings can only be used with the correct and agreed licence that has been granted by SMARTePLANS to the person whose name is on the drawing and for the sole purpose of obtaining the single permission the drawing relates to. It has not been granted for third party use. Refer any discrepancy to SMARTePLANS. The client is responsible for defining the correct boundaries & site ownership. SMARTePLANS cannot be held responsible for subsequent Land disputes or any material loss when obtaining information from this plan. It is the responsibility of the client to wait for planning & building regulations approval before commissioning any works.

Rev	Description	Date

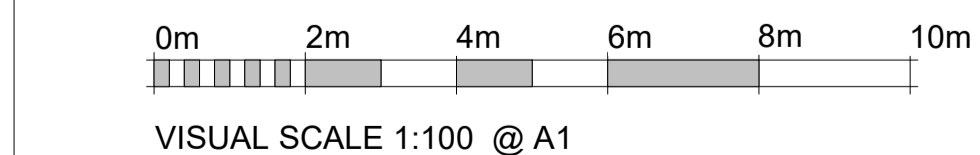

LICENSE PURPOSE	CODE	TITLE
Client Approval Only	C/A/O	Existing & Proposed Plans & Elevations
PURPOSE OF ISSUE	STATUS	
DRAFT Issue Only	D/I/O	

CLIENT Joseph Amissh-Mensah 36 Aplin Road, Aylesbury, HP21 9BT			
SCALE (@ A1) 1 : 100	PROJECT No.	DATE 28/12/2020	REV
DRAWN BY SMARTePLANS®	CHECKED BY SMARTePLANS®	DATE 28/12/2020	REV
SHEET NUMBER A1-02			