

EXTERNAL LIGHTING

SCALE - NTS

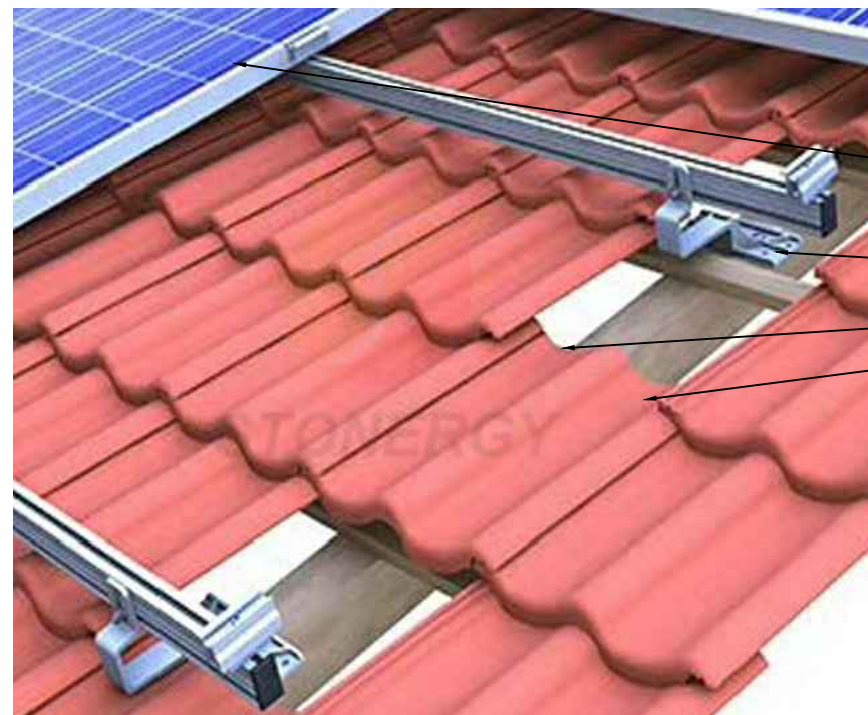

SATELLITE DISH AND BRACKET

SCALE - NTS

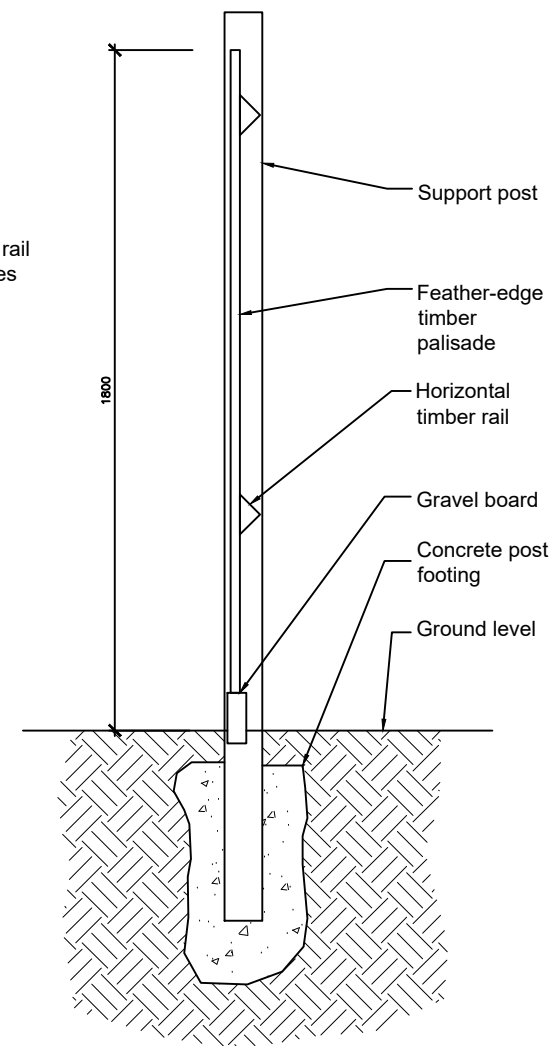

TIMBER FENCE DETAIL

SCALE - 1:20

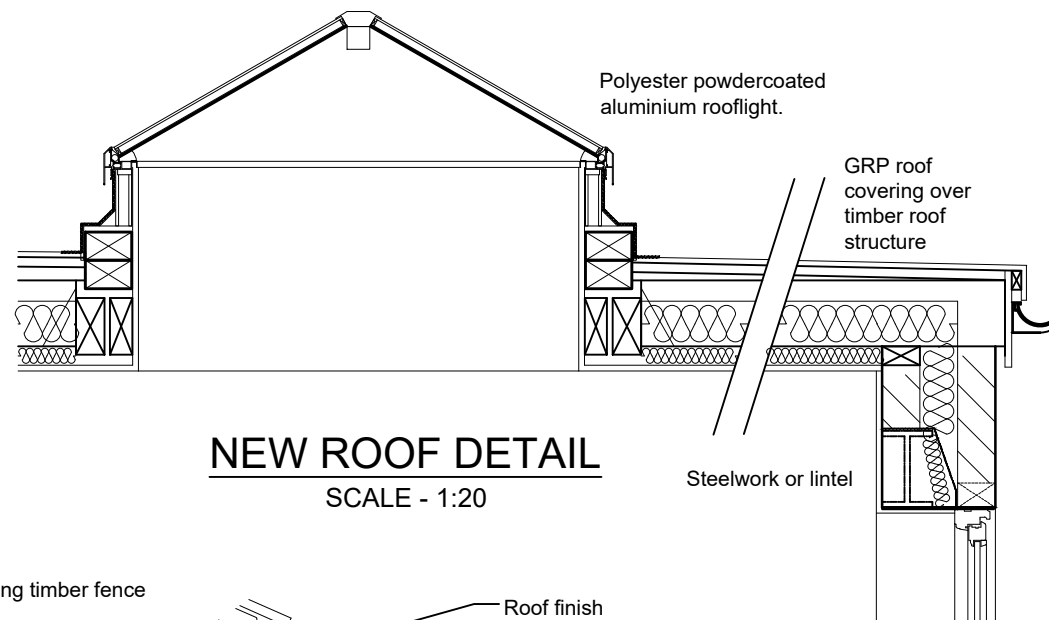

NEW ROOF DETAIL

SCALE - 1:20

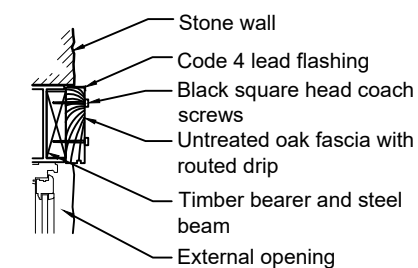

OAK FASCIA DETAIL

SCALE - 1:20



Fixing point to wall using stainless rawlbolt or similar

SATELLITE DISH AND BRACKET

SCALE - NTS



Fixing point to wall using stainless rawlbolt or similar

TV AERIAL AND BRACKET

SCALE - NTS

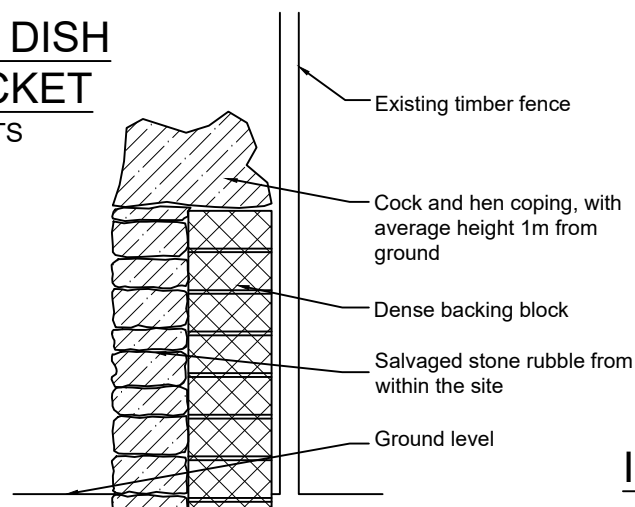

STONE WALL DETAIL

SCALE - 1:20

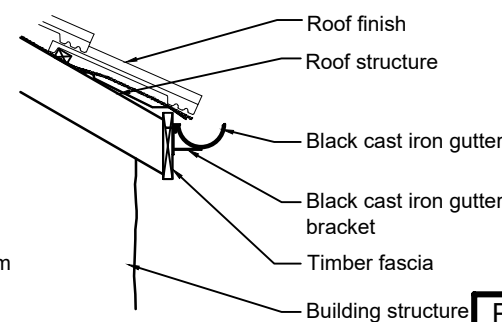

IRON GUTTER DETAIL

SCALE - 1:20

Project: Existing and Proposed Alterations		Title: Associated Site Details	
Address: 117a & 117b High Street Portishead Bristol		Scale(s): As Shown	Drawn: DGT
		Drwg No.: HIG117AB/LBC/21/06	Rev.
		 T: 07920 557247 E: darren@bsc.limited	



100 A3 paper