

Electrostatic Precipitator



Manual Clean & Autowash System

the ESP solution to grease and smoke pollution...

Local Legislation

Local Legislation requires increasingly that the amount of grease and smoke in kitchen exhaust fumes is reduced to lessen the nuisance of smells to the neighbourhood. Our ESP system gives the restaurant a clean, non-polluting image, while complying with local legislation.

Fire Risk Reduction

Grease build up in the ducting is significantly reduced with an ESP. This reduces the risk of fire in the ducts and fire spreading from the source to different parts of the building.

Efficiency

The ESP system is a very efficient means for removing particles and it can remove particles down to sub-micron size (0,01). When installed correctly, the unit can achieve an efficiency up to 98%.

Pre and After Filters and Oil Drain

Each unit is provided with standard mesh filters designed to protect the electrostatic filter section (Mesh filters are not provided with Autowash). We can also provide specialist oil demisters and other pre filters for different applications. The units are all fitted with a drip tray and an oil drain point to allow collected waste grease and oil to be drained away.

Installations

The ESP is installed inline in the ducting. The unit should be located as close as possible to the extraction hood to reduce grease build up within the ducting. This reduces the need for regular duct cleaning. If space is limited in the kitchen then the unit(s) can also be installed outside, upstream of the extraction fan. Several ESP units, stacked as modules, can be used as a central filter installation with a virtually unlimited capacity.

Pressure Loss

The ESP is characterised by a remarkably low pressure drop (120-190 Pa). The advantage is that existing extract fans often do not need to be replaced.

Maintenance

Only regular cleaning of the filters, ioniser and collector cells with warm water and detergent is needed. Purified Air offer a cleaning and maintenance service operating on an exchange system. This is a cost effective service available in the UK direct from the manufacturer and in other selected countries via our agents. Taking out a maintenance contract ensures that your system is in full working condition at all times. This assumes an appropriate maintenance frequency and professional cleaning. The maintenance of the ducting and any other filter present in the ducting can be reduced (lower frequency) because of the effectiveness of the ESP. Please also see **optional Autowash system**.

The Electrostatic Precipitator is suitable for the removal of all grease and odour emissions from commercial kitchens



Any amount of grease and smoke can be eliminated. Purified Air has the complete solution for any kitchen or cooking method. The ESP system is supplemented by a number of other technologies manufactured by Purified Air designed to combat cooking odours, these systems comprise of UV-C, electronic and chemical neutralising and specially designed media and micro porous filters.

Solving kitchen emission problems

Kitchen fume problems are not exclusively about the nuisance of grease or exclusively about odours. Both problems need to be solved 'at source'. The ESP system is the second stage of a sacrificial system, the first being the canopy filters and the third being methods for gaseous or odour control. The ESP is part of a family of products designed to eliminate grease, smoke and odour problems from commercial kitchens. The duct-installed ESP systems trap the smaller grease particles and other contaminants that pass the grease filters in the cooker hood.

AUTOWASH option...

The Autowash system has been designed as a cost efficient alternative to the manual wash type. The process is designed to operate a daily program to ensure that the electrostatic components remain in a clean and serviceable condition. As the program operates daily not only are there significant savings with maintenance costs but as the components are in a near new condition the performance of the electrostatic filter will always be at optimum. As components become dirty during normal use the filtration efficiency reduces as the dirt on the collectors builds up to form insulation, this affect will be minimised with the Autowash process. It should be noted that the Autowash system will still require some periodical manual maintenance.

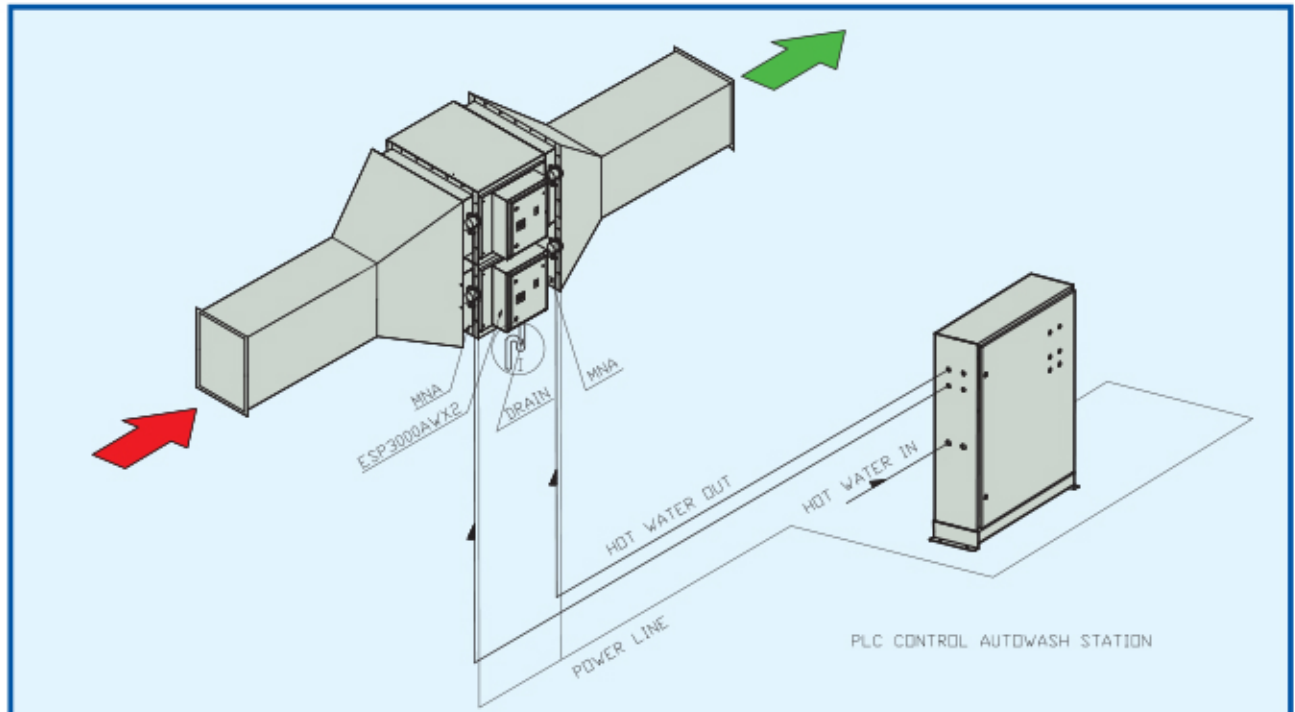

The design uses minimal, energy, water and detergent so the overall process is cost-efficient. The system is designed to operate during the period when the kitchen is closed. The wash cycle is controlled via a PLC module and has several stages as follows:

1. The ESP system and the main extract fan are switched off.
2. First detergent cycle.
3. First rinse cycle.
4. Second detergent cycle.
5. Second rinse cycle.
6. Drying stage using the main extract fan.
7. Finally the extract system and the ESP are reactivated so that they are ready to switch on for the next day of operation.

The ESP module has been redesigned so that all 2011 generation models onwards can incorporate the Autowash option. Any new generation unit can be converted to an Autowash system you simply need to add the MNA (motorised nozzle attachment) to each flange of the ESP. The flanges are pre drilled to mate up. Once this is done the unit is simply connected to an Autowash cabinet.

The Principle of Electrostatic Precipitators

The ESP units are used to clean the airstream of grease and hydrocarbons (smoke) in kitchen exhaust systems. They are highly efficient and can remove particulate down to sub-micron (0.01micron) size. The filter efficiency of up to 98% is attained during a single pass through the ESP, based on the charging of particles by an ionisation section which are then trapped on the earth plates in the collector cell. Larger particulate in the airstream can be removed by the pre-filter and lastly an after filter can prevent any re-entrainment of agglomerated grease on the collector and aids good air distribution.

The Autowash Modular System



ESP 1500 AW

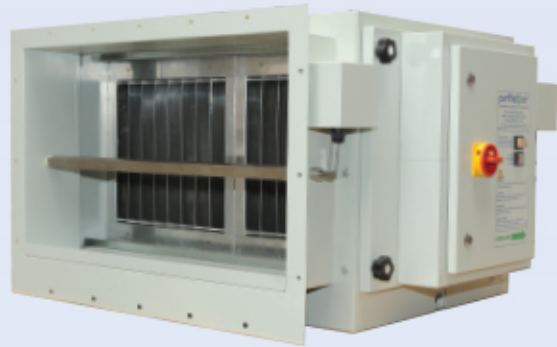

ESP 3000 AW

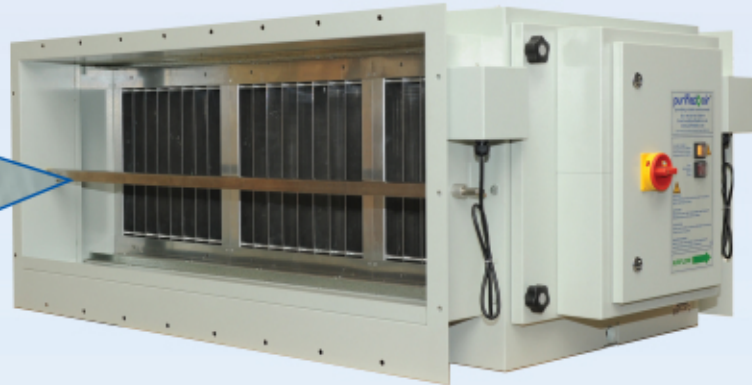
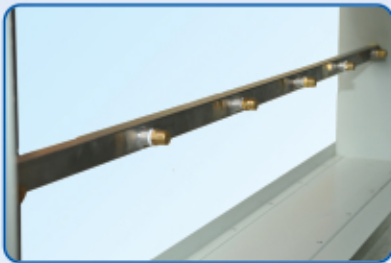

ESP 4500 AW



AUTOWASH CABINET



INTERIOR OF AUTOWASH CABINET

The ESP Modular System



ESP 3000 E

All units can be used individually or combined for greater air flows.



ESP 1500 E



Two ESP 3000 E in modular format



ESP 4500 E

Construction

ESP air cleaners are precision engineered to current industrial standards.

The case is of galvanised construction, spot welded and fitted with heavy duty hinges and bolt-on door equipped with compression locks.

Industrial neoprene seals fitted all round.

The ESP range of units are designed so that the direction of airflow can be easily altered from left to right or right to left. A simple operation using basic tools And changing the legend sticker which can be carried out in about fifteen minutes.

Efficiency Achievable

Particulate Micron	Efficiency
0.01	up to 98%
0.1	up to 97%
10.0	up to 98%

Efficiency can vary with different particulate and air volumes.

Maintenance

ESP air cleaners require only routine maintenance as all filter components are cleanable by means of steam, detergent, or pressure jet.* Autowash models are largely self cleaning but do still need periodic manual maintenance.

*excluding media filters where used.

AW STATION.....	78kg
AIR VOLUME MAX.....	2500m ³ /h 1500cfm
ELECTRICAL SUPPLY.....	220/240V 50Hz 1ph
POWER CONSUMPTION.....	30W
WEIGHT.....	E = 55kg, AW = 68kg
MIN/MAX WORKING TEMP.....	4/56°C
MAX RELATIVE HUMIDITY.....	75%

The design of cooking exhaust control systems varies. Different types of cooking and location have separate requirements and may require additional equipment. The equipment in this brochure is designed to be used in conjunction with other items of our manufacture. Purified Air Limited offer a free consultation service and will assist you with design, please discuss your project with us before selecting equipment.



Filter Technology

- 1 Pre-filter**
Eurovent Class 9
- 2 Ionisation section**
- 3 Collector section**
Eurovent class 9
Filter surface 15m² per collector
(ESP 1500E 15m²,
ESP 3000E 30m²,
ESP 4500 45m²)
- 4 Final filter**
Eurovent Class 9

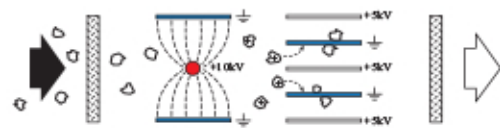
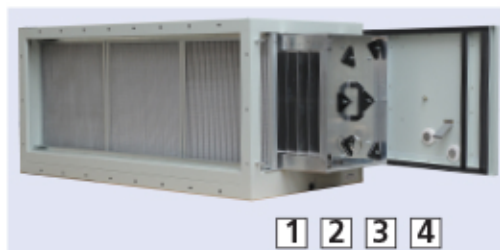

Standards

The ESP Units comply with current IEE, CE and other European standards, including the Health and Safety at Work Act. Rated to IP 53.

Controls

A separate enclosure houses the HT supply, and operation indicators. We can also offer remote control of the system and integrated plc fault reading which will text or send an e-mail if a fault is detected. Please discuss additional control systems when ordering or planning a project!

Dimensions

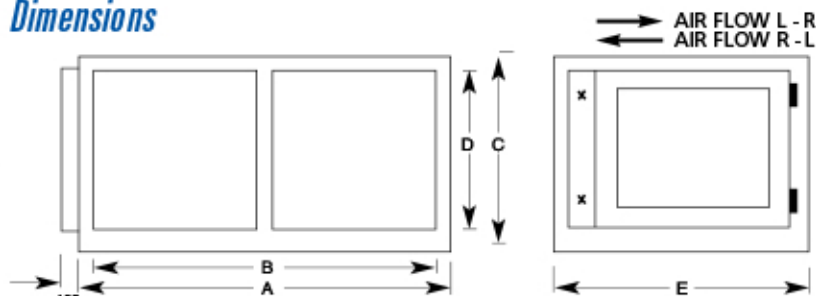

	ESP 1500	E	AW	ESP 3000	E	AW	ESP 4500	E	AW
A - Width	450mm	450mm	900mm	900mm	1350mm	1350mm			
B - Width	350mm	350mm	800mm	800mm	1250mm	1250mm			
C - Height	630mm	630mm	630mm	630mm	630mm	630mm			
D - Height	485mm	485mm	485mm	485mm	485mm	485mm			
E - Depth	660mm	860mm	660mm	860mm	660mm	860mm			

5000m ³ /h 3000cfm	7500m ³ /h 4500cfm
220/240V 50Hz 1ph	220/240V
50W	50W
E = 85kg, AW = 100kg	E = 118kg, AW = 138kg
4/56°C	4/56°C
75%	75%

Installation of grease smoke and odour equipment must be made on the negative side of the fan and the systems must be switched via an interlock to ensure they are only operational when the extract fan is operational. If there is ductwork inside the premises on the positive side of the fan please ensure that it is completely sealed so as not to let fumes or odour control compounds back into the premises. In certain instances some equipment can be installed on the positive side of the fan but please discuss this with our technical department and ask them to provide a design statement to confirm that it can be done.

purified air
providing a better environment

Purified Air Limited, Lyon House,
Lyon Road, Romford, Essex RM1 2BG England
Tel: (01708) 75414 Fax: (01708) 721488
Email: enq@purifiedair.co.uk
www.purifiedair.co.uk