

**NOTES:-** RESPONSIBILITY IS NOT ACCEPTED FOR ERRORS MADE BY OTHERS IN SCALING FROM THIS DRAWING. ALL CONSTRUCTION INFORMATION SHOULD BE TAKEN FROM FIGURED DIMENSIONS ONLY. ALL DIMENSIONS ARE IN MILLIMETERS

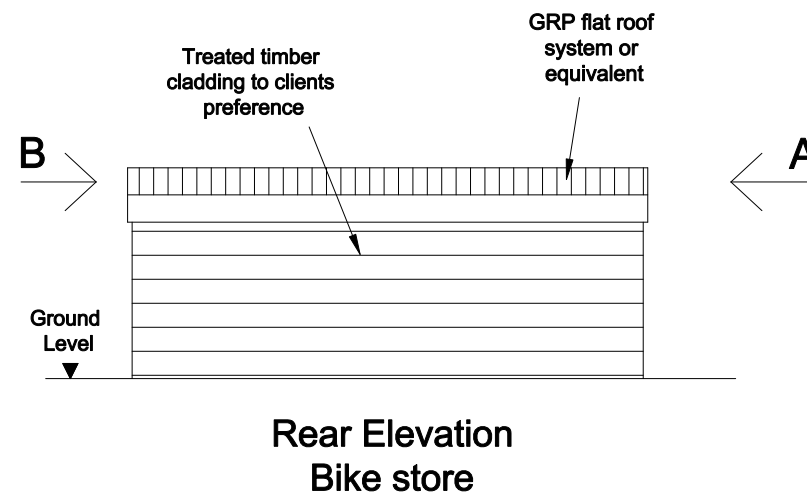
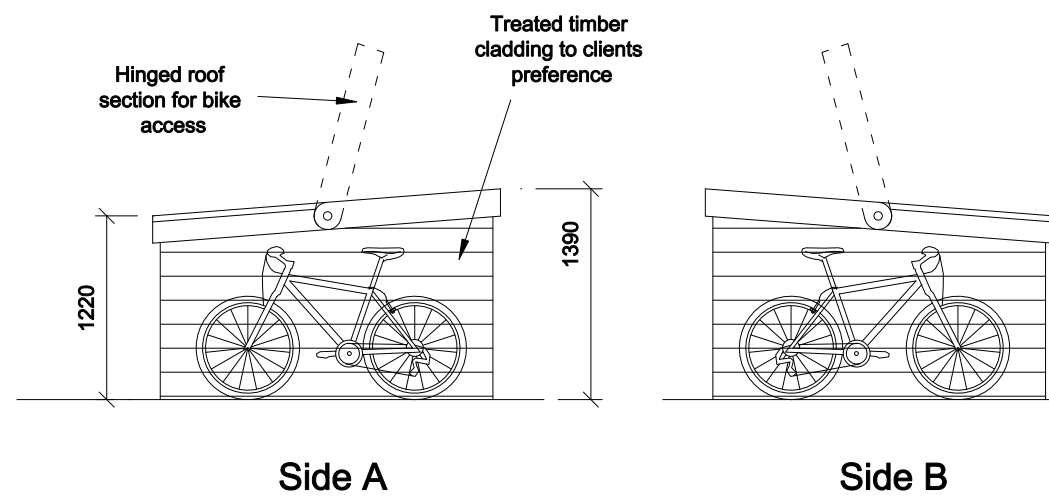
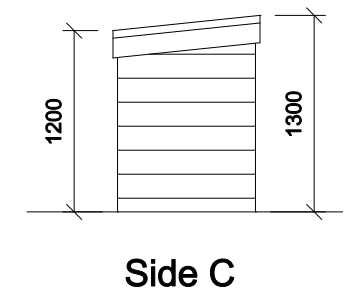
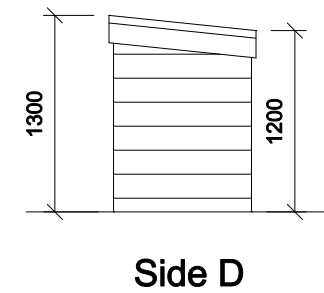
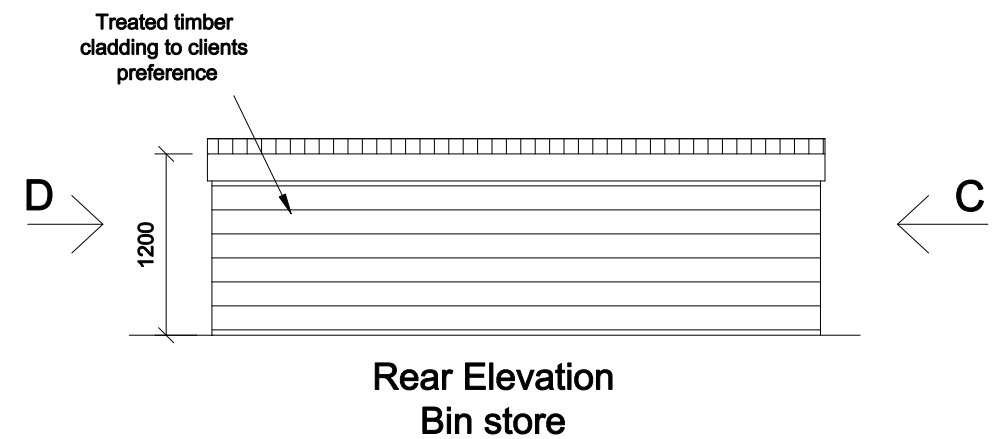
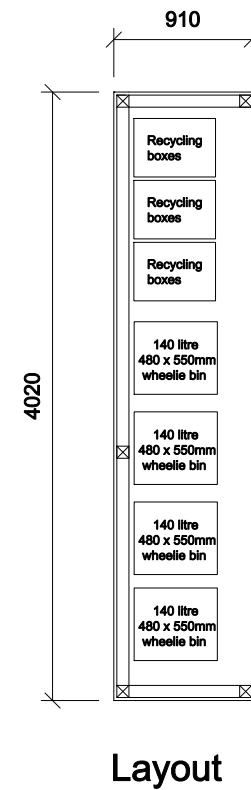
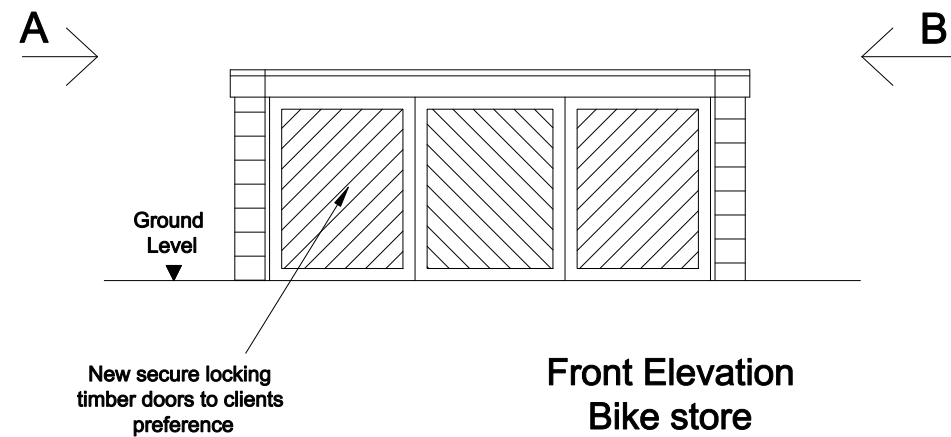
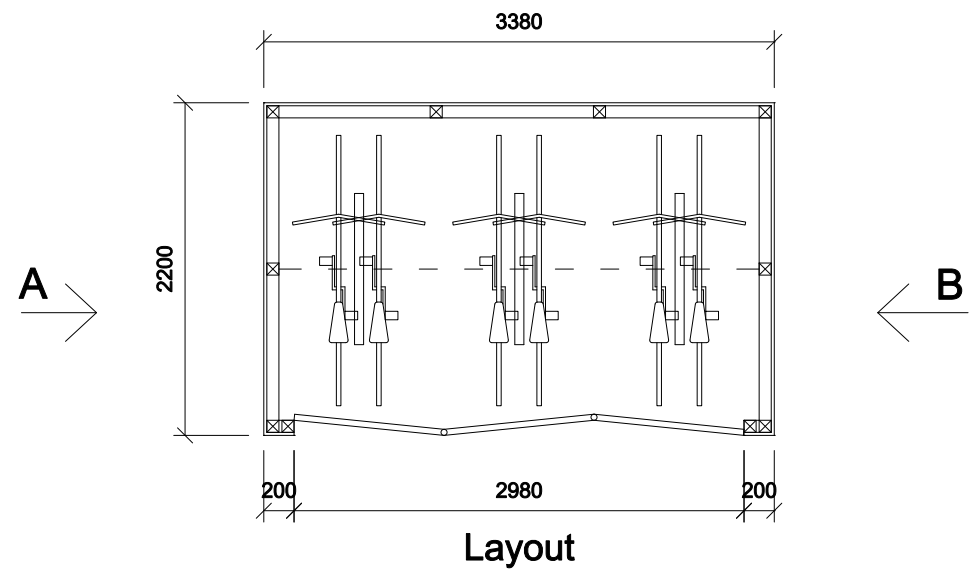

**Clifton Design (Bristol)**  
 25 Lower Redland Road  
 Redland  
 Bristol  
 BS6 6TB  
 0117 973 6000

Rev:	Description of Changes:
-	-

Drawn:	Date:
-	-

**Client:**  
**Mrs A Haynes**  
**Address:**  
**106 Coronation Road, Southville**

**Postcode:**  
**BS3 1AX**  
**Date:**  
**Feb 2021**

**Drawing Title:**  
**Bike / Bin Store Details**  
**Drawing No:** 106/CR/S/13/P  
**Drawn:** D.H    **Option:** -    **Rev:** -

