

SITE LOCATION

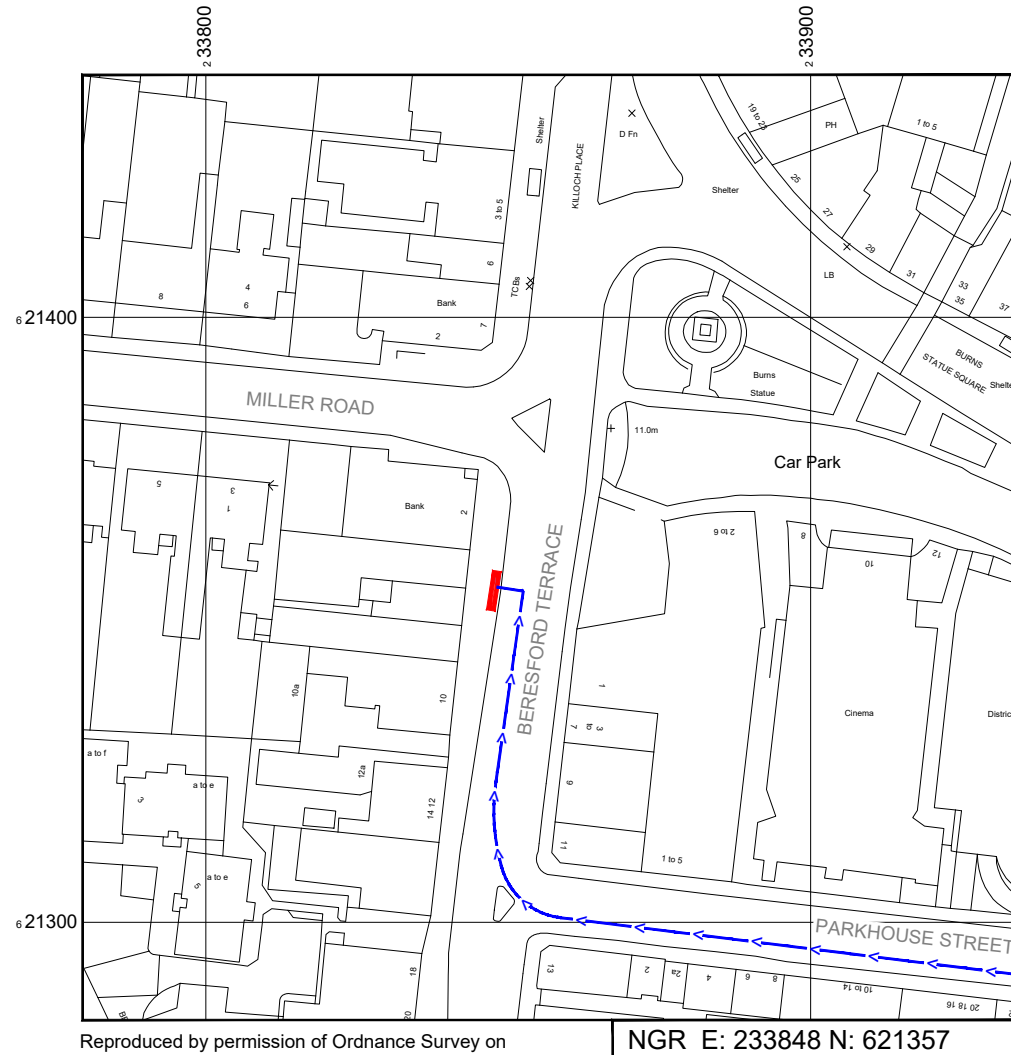

Reproduced by permission of Ordnance Survey on behalf of the Controller of Her Majesty's Stationery Office
All rights reserved. © Crown Copyright licence no. TBC



Reproduced by permission of Ordnance Survey on behalf of the Controller of Her Majesty's Stationery Office
All rights reserved. © Crown Copyright licence no. TBC

NGR E: 233848 N: 621357

SITE AREA PLAN

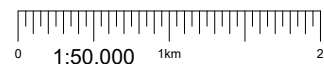

SITE LOCATION PLAN

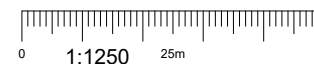

SITE PHOTOGRAPH



GOOGLE MAPS QR CODE

GOOGLE MAPS - <https://goo.gl/maps/WsrGz8nUh4cXD4aw6>

GOOGLE STREETVIEW - <https://goo.gl/maps/iwrCsfAVaMTk3FU97>

NOTES:

1. ALL DIMENSIONS IN MM UNLESS OTHERWISE NOTED.

DIRECTIONS TO SITE:

Heading South on the A77, at the roundabout take the 3rd exit onto Holmston Rd/A70. At the next roundabout take the 1st exit and stay on Holmston Rd, at the next roundabout take the 2nd exit onto Station Bridge/A70. Use any lane to turn left onto Parkhouse St/A70 and use any lane to turn right onto Parkhouse St, turn right onto Station rd/A70 and site location is on the left hand side.

Site Provider's Property Boundary:



Access Route To Site:



Access Route:



Master:	MBNL / EE / H3G:	Project:	Purpose of Issue:	Issue:
M001	MBNL	H3G 5G UNILATERAL	Planning	A
Date:	11/02/2021	Revision / Upgrade Description:		
Drawn:	V4RAD	First Issue - Site nomination dated: 10/12/20		
Checked:	DH			
Approved:	SD			



Hutchison 3G UK Limited
Star House, 20 Grenfell Road
Maidenhead, SL6 1EH
Tel: 01628 765 000
Fax: 01628 765 001

H3G Base Station Information line:
0845 6043000
Available 8am-8pm Monday to Friday

Design Consultant & Principal Contractor:



WHP Telecoms
Unit 1 Maple Park,
Low Fields Avenue, Leeds
LS12 6HH

Tel: 01133023550
e-mail: info@whptelecoms.com

Site Name:

SW AT BERESFORD TERRACE

Site ID:

SAY24732

Address:

BERESFORD TERRACE,
AYR,
SOUTH AYRSHIRE, KA7
2ER

Title:

002 SITE LOCATION PLAN

Project:

H3G 5G UNILATERAL

Purpose of Issue:

PLANNING

EE Cell ID:	MBNL Cell ID:	3UK Cell ID:
N/A	N/A	N/A

Master Drawing No:	Issue:
SAY24732_M002	B



NOTES:

1. ALL DIMENSIONS IN MM UNLESS OTHERWISE NOTED.

Master:	MBNL / EE / H3G:	Project:	Purpose of Issue:	Issue:
M001	MBNL	H3G 5G UNILATERAL	Planning	A
Date:	11/02/2021	Revision / Upgrade Description:		
Drawn:	V4RAD	First Issue - Site nomination dated: 10/12/20		
Checked:	DH			
Approved:	SD			



Hutchison 3G UK Limited
Star House, 20 Grenfell Road
Maidenhead, SL6 1EH
Tel: 01628 765 000
Fax: 01628 765 001

H3G Base Station Information line:
0845 6043000
Available 8am-8pm Monday to Friday

Design Consultant & Principal Contractor:



WHP Telecoms
Unit 1 Maple Park,
Low Fields Avenue, Leeds
LS12 6HH

Tel: 01133023550
e-mail: info@whptelecoms.com

Site Name:

SW AT BERESFORD TERRACE

Site ID:

SAY24732

Address:

BERESFORD TERRACE,
WALLACETOWN,
AYR,
SOUTH AYRSHIRE,
KA7 2ER

Title:

100 EXISTING SITE PLAN

Project:

H3G 5G UNILATERAL

Purpose of Issue:

PLANNING

EE Cell ID:	MBNL Cell ID:	3UK Cell ID:
N/A	N/A	N/A

Master Drawing No:

SAY24732_M002

Issue:

B

NOTES:
 1. ALL DIMENSIONS IN MM UNLESS OTHERWISE NOTED.

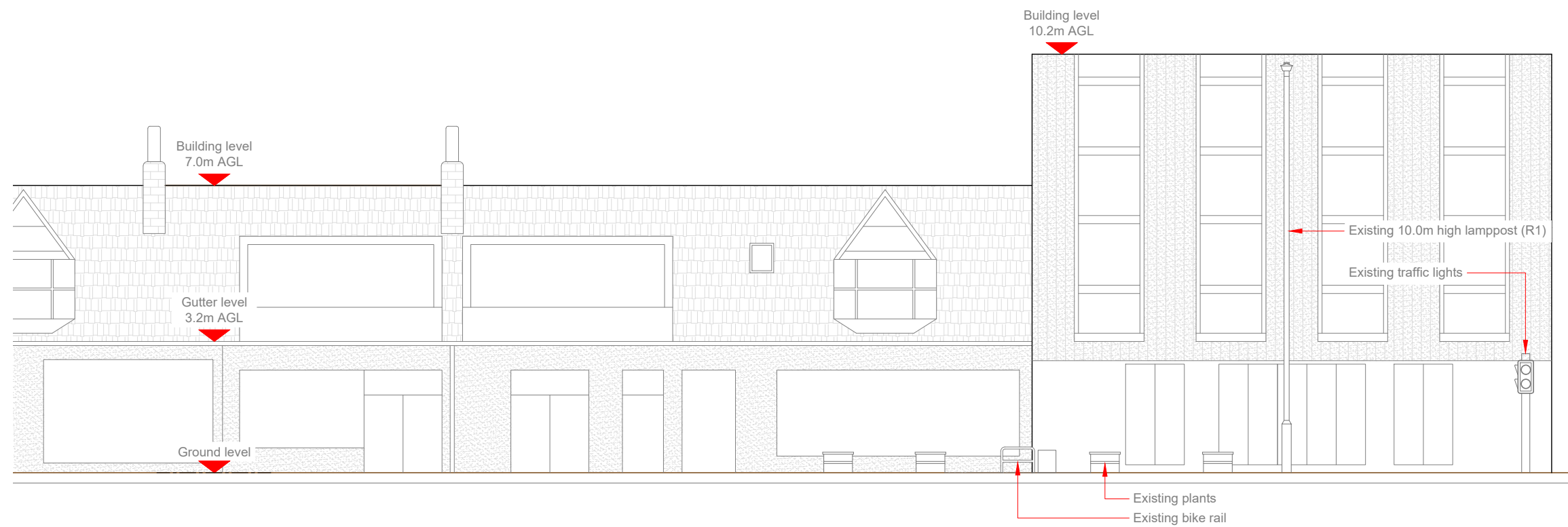

EXISTING ELEVATION A

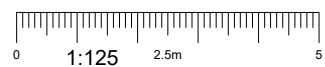

Master:	MBNL / EE / H3G:	Project:	Purpose of Issue:	Issue:
M001	MBNL	H3G 5G UNILATERAL	Planning	A
Date:	11/02/2021	Revision / Upgrade Description:		
Drawn:	V4RAD	First Issue - Site nomination dated: 10/12/20		
Checked:	DH			
Approved:	SD			



Hutchison 3G UK Limited
 Star House, 20 Grenfell Road
 Maidenhead, SL6 1EH
 Tel: 01628 765 000
 Fax: 01628 765 001

H3G Base Station Information line:
 0845 6043000
 Available 8am-8pm Monday to Friday

Design Consultant & Principal Contractor:



WHP Telecoms
 Unit 1 Maple Park,
 Low Fields Avenue, Leeds
 LS12 6HH

Tel: 01133023550
 e-mail: info@whptelecoms.com

Site Name:

SW AT BERESFORD TERRACE

Site ID:

SAY24732

Address:

BERESFORD TERRACE,
 WALLACETOWN,
 AYR,
 SOUTH AYRSHIRE,
 KA7 2ER

Title:

150 EXISTING ELEVATION A

Project:

H3G 5G UNILATERAL

Purpose of Issue:

PLANNING

EE Cell ID:	MBNL Cell ID:	3UK Cell ID:
N/A	N/A	N/A

Master Drawing No:	Issue:
SAY24732_M002	B



Flat Roof Level
10.2m AGL



Building Level
5.0m AGL



Building Level
3.2m AGL



Ground Level
0.00m AGL



Existing 10.0m high lamppost (R1)

Existing plants

Existing bike rail

Existing plants

Proposed Phase 8 monopole c/w
wraparound cabinet at base

Proposed 2No. H3G cabinets

Proposed G-100876 cabinet

BERESFORD TERRACE
(30mph)

ELEVATION A



Antenna Aperture ID	Proposed 4G/5G Bearing	Operator: Shared/EE/H3G
A1	30°	H3G
A2	30°	H3G
B1	150°	H3G
B2	150°	H3G
C1	270°	H3G
C2	270°	H3G

NOTES:

- ALL DIMENSIONS IN MM UNLESS OTHERWISE NOTED.

Master: M001	MBNL / EE / H3G:	Project: H3G 5G UNILATERAL	Purpose of Issue: Planning	Issue: A
Date: 11/02/2021	Revision / Upgrade Description:			
Drawn: V4RAD	First Issue - Site nomination dated: 10/12/20			
Checked: DH				
Approved: SD				



Hutchison 3G UK Limited
Star House, 20 Grenfell Road
Maidenhead, SL6 1EH
Tel: 01628 765 000
Fax: 01628 765 001

H3G Base Station Information line:
0845 6043000
Available 8am-8pm Monday to Friday

Design Consultant & Principal Contractor:



WHP Telecoms
Unit 1 Maple Park,
Low Fields Avenue, Leeds
LS12 6HH

Tel: 01133023550
e-mail: info@whptelecoms.com

Site Name:

SW AT BERESFORD TERRACE

Site ID:

SAY24732

Address:

BERESFORD TERRACE,
WALLACETOWN,
AYR,
SOUTH AYRSHIRE,
KA7 2ER

Title:

210 PROPOSED H3G SITE PLAN

Project:

H3G 5G UNILATERAL

Purpose of Issue:

PLANNING

EE Cell ID: N/A	MBNL Cell ID: N/A	3UK Cell ID: N/A
--------------------	----------------------	---------------------

Master Drawing No: SAY24732_M002	Issue: B
-------------------------------------	-------------

PROPOSED H3G CONFIGURATION SITE PLAN

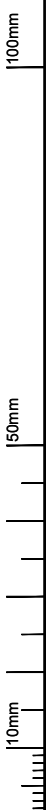
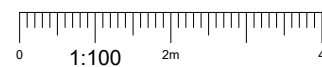

Antenna Aperture ID	Proposed 4G/5G Bearing	Operator: Shared/EE/H3G
A1	30°	H3G
A2	30°	H3G
B1	150°	H3G
B2	150°	H3G
C1	270°	H3G
C2	270°	H3G

NOTES:
1. ALL DIMENSIONS IN MM UNLESS OTHERWISE NOTED.

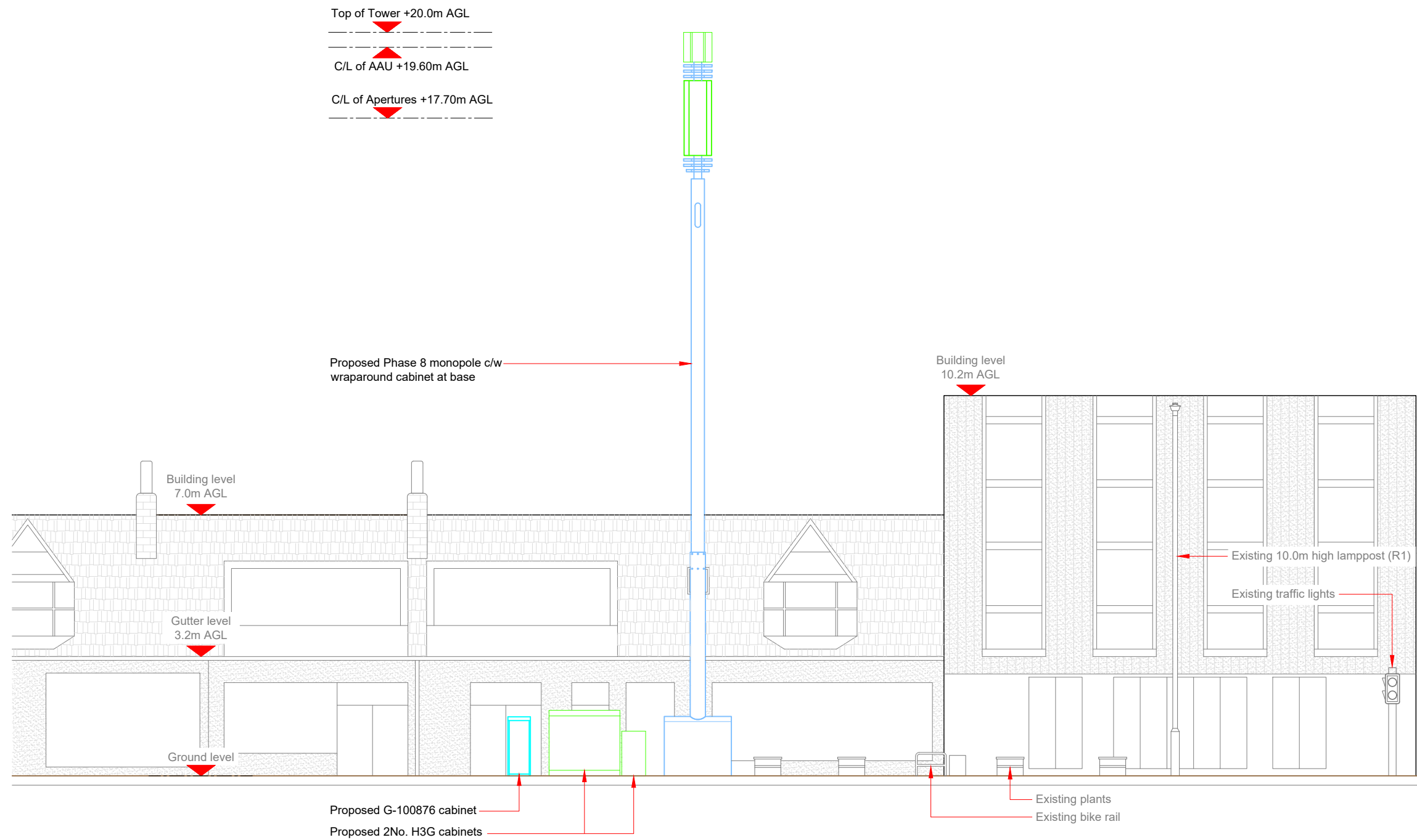

PROPOSED H3G CONFIGURATION ELEVATION

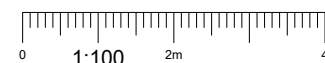

Master: M001	MBNL / EE / H3G:	Project: H3G 5G UNILATERAL	Purpose of Issue: Planning	Issue: A
Date: 11/02/2021	Drawn: V4RAD	Revision / Upgrade Description: First Issue - Site nomination dated: 10/12/20		
Checked: DH	Approved: SD			



Hutchison 3G UK Limited
 Star House, 20 Grenfell Road
 Maidenhead, SL6 1EH
 Tel: 01628 765 000
 Fax: 01628 765 001

 H3G Base Station Information line:
 0845 6043000
 Available 8am-8pm Monday to Friday

Design Consultant & Principal Contractor:
 **WHP Telecoms**
 Unit 1 Maple Park,
 Low Fields Avenue, Leeds
 LS12 6HH
 Tel: 01133023550
 e-mail: info@whptelecoms.com

Site Name: **SW AT BERESFORD TERRACE**

Site ID: **SAY24732**

Address: **BERESFORD TERRACE,
 WALLACETOWN,
 AYR,
 SOUTH AYRSHIRE,
 KA7 2ER**

Title: **260 PROPOSED H3G ELEVATION**

Project: **H3G 5G UNILATERAL**

Purpose of Issue: **PLANNING**

EE Cell ID: N/A	MBNL Cell ID: N/A	3UK Cell ID: N/A
---------------------------	-----------------------------	----------------------------

Master Drawing No: **SAY24732_M002** Issue: **B**

Proposed H3G Antenna Aperture Schedule & RF Equipment Capacity

Antenna Aperture ID	Antenna Aperture Size (Length x Width x Depth)	Aperture Height C/L	Aperture Max Weight (kg)	Proposed 4G/5G Bearing	Tech: 4G/5G	Operator: Shared/EE/H3G	Antenna Aperture Coordinates		RRU No. Max Size & Weight L<=500mm W=400mm D=150mm Weight<=25kg	MHA No. Max Size & Weight L<=300mm W=300mm D=150mm Weight<=10kg	Main Feeder			BOB Max Size & Weight (300x300x250mm & 5kg)		Active Router No. Max Size & Weight (370x260x150mm & 10kg)	Passive Router No. Max Size & Weight (350x220x150mm & 10kg)
							Eastings	Northings			Size	Length	No.	No. Top	No. Bottom		
A1	795x395x220mm	19.60m	45kg	30°	5G	H3G	-	-	0	0	TBC	TBC	4	1	1	1	1
A2	2009x469x206mm	17.70m	TBC	30°	3G/4G	H3G	-	-	3	0	TBC	TBC	4	1	1	1	1
B1	795x395x220mm	19.60m	45kg	150°	5G	H3G	-	-	0	0	TBC	TBC	4	1	1	1	1
B2	2009x469x206mm	17.70m	TBC	150°	3G/4G	H3G	-	-	3	0	TBC	TBC	4	1	1	1	1
C1	795x395x220mm	19.60m	45kg	270°	5G	H3G	-	-	0	0	TBC	TBC	4	1	1	1	1
C2	2009x469x206mm	17.70m	TBC	270°	3G/4G	H3G	-	-	3	0	TBC	TBC	4	1	1	1	1

STATUS KEY:

- Installed:** Existing
- Retain:** Existing and to remain
- Relocate:** Existing and to be relocated
- Remove:** Existing to be removed from site
- Proposed:** New on site

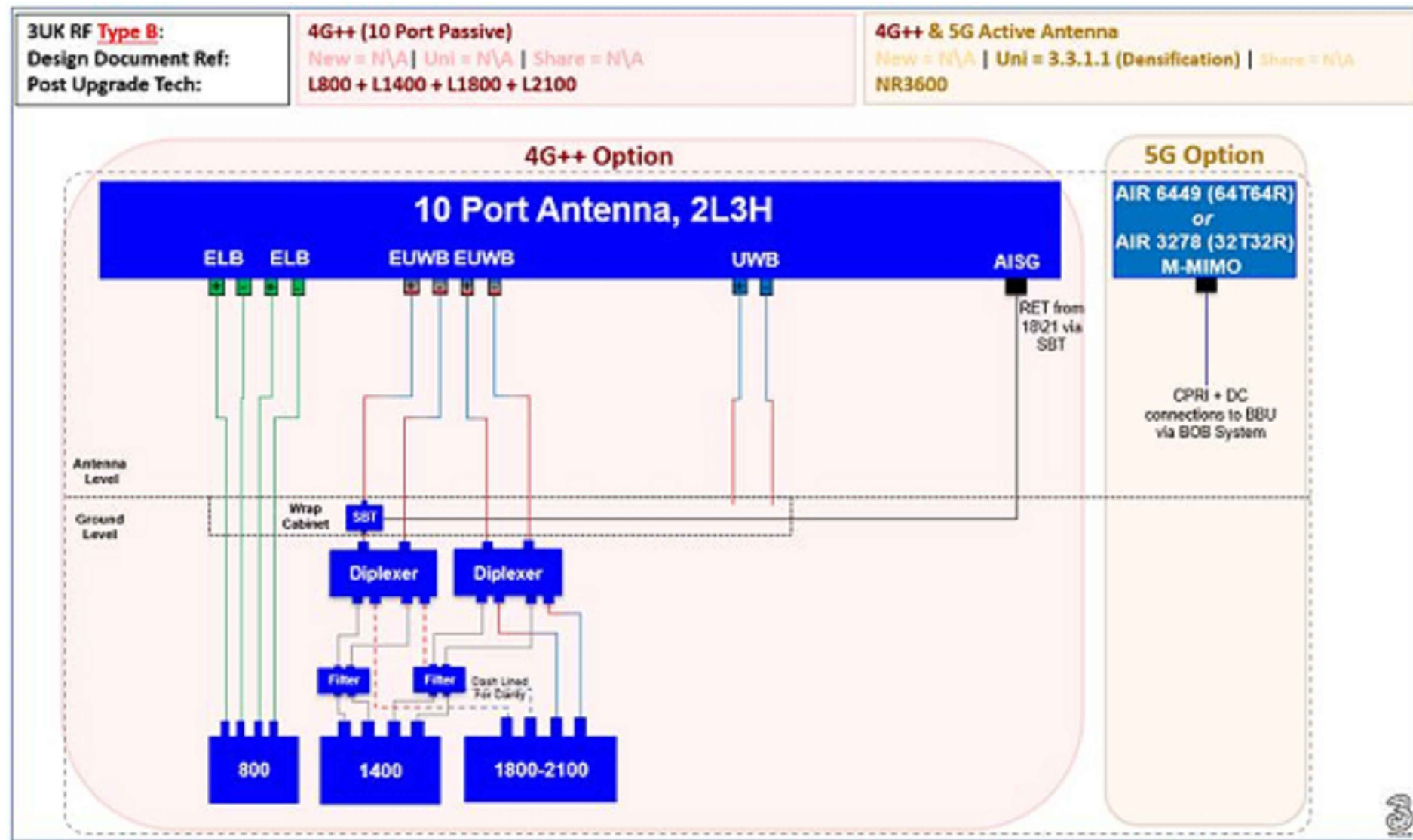

Master: M001	MBNL / EE / H3G: MBNL	Project: H3G 5G UNILATERAL	Purpose of Issue: Planning	Issue: A
Date: 11/02/2021	Revision / Upgrade Description:			
Drawn: V4RAD	First Issue - Site nomination dated: 10/12/20			
Checked: DH				
Approved: SD				



Hutchison 3G UK Limited
 Star House, 20 Grenfell Road
 Maidenhead, SL6 1EH
 Tel: 01628 765 000
 Fax: 01628 765 001

H3G Base Station Information line:
 0845 6043000
 Available 8am-8pm Monday to Friday

Design Consultant & Principal Contractor:

WHP Telecoms
 Unit 1 Maple Park,
 Low Fields Avenue, Leeds
 LS12 6HH

Tel: 01133023550
 e-mail: info@whptelecoms.com

Site Name: SW AT BERESFORD TERRACE

Site ID: SAY24732

Address: BERESFORD TERRACE,
 WALLACETOWN,
 AYR,
 SOUTH AYRSHIRE,
 KA7 2ER

Title: 302 PROPOSED H3G ANTENNA
 SCHEDULE & LINE CONFIGURATION

Project: H3G 5G UNILATERAL

Purpose of Issue: PLANNING

EE Cell ID: N/A	MBNL Cell ID: N/A	3UK Cell ID: N/A
-----------------	-------------------	------------------

Master Drawing No: SAY24732_M002 Issue: B

100mm
50mm
10mm

Support Structure Schedule

Structure ID	Status	Equipment Description / Type	Structure Manufacturer	Height AGL (m)	Colour (RAL Colour)	Headframe Details	Foundation / Support Grillage / Host Structure Details	Support Bolt Details	MBNL Ref:	Comments
ST1	Proposed	Phase 8	-	20.0m	Galvanised	-	Root Foundation	-	-	

STATUS KEY:

Installed: Existing
Retain: Existing and to remain
Relocate: Existing and to be relocated
Remove: Existing to be removed from site
Proposed: New on site

LOCATION KEY:

Outdoor: Located outside
Indoor: Located within an equipment cabin or equipment room
Internal: located inside a cabinet or item of equipment

Equipment Schedule

Equipment ID	Quantity	Status	Equipment Description / Type	Equipment Manufacturer	Dimensions (W x D x H)	Weight (kg)	Colour (RAL Colour)	Material	Location	Power	Power cable length (m)	MBNL Ref:	Comments
CAB1	1	Proposed	H3g - Ericsson 6130	-	640x480x1200	-	Grey	Steel	Outdoor	-	-	-	
CAB2	1	Proposed	H3g - Bowler	-	600x1750x1900	-	Grey	Steel	Outdoor	-	-	-	
CAB3	1	Proposed	Power/TX	-	600x520x1585	-	Grey	Steel	Outdoor	-	-	-	
CAB4	1	Proposed	Diplexer Cabinet	-	1800x750x1600	-	Grey	Steel	Outdoor	-	-	-	

Master: M001	MBNL / EE / H3G: MBNL	Project: H3G 5G UNILATERAL	Purpose of Issue: Planning	Issue: A
Date: 11/02/2021	Revision / Upgrade Description:			
Drawn: V4RAD	First Issue - Site nomination dated: 10/12/20			
Checked: DH				
Approved: SD				



Hutchison 3G UK Limited
 Star House, 20 Grenfell Road
 Maidenhead, SL6 1EH
 Tel: 01628 765 000
 Fax: 01628 765 001

 H3G Base Station Information line:
 0845 6043000
 Available 8am-8pm Monday to Friday

Design Consultant & Principal Contractor:



WHP Telecoms
 Unit 1 Maple Park,
 Low Fields Avenue, Leeds
 LS12 6HH

 Tel: 01133023550
 e-mail: info@whptelecoms.com

Site Name: **SW AT BERESFORD TERRACE**

Site ID: **SAY24732**

Address: **BERESFORD TERRACE,
 WALLACETOWN,
 AYR,
 SOUTH AYRSHIRE,
 KA7 2ER**

Title: **305 EQUIPMENT SCHEDULE &
 SUPPORT STRUCTURE DETAILS**

Project: **H3G 5G UNILATERAL**

Purpose of Issue: **PLANNING**

EE Cell ID: N/A	MBNL Cell ID: N/A	3UK Cell ID: N/A
---------------------------	-----------------------------	----------------------------

Master Drawing No: **SAY24732_M002** Issue: **B**

100mm
50mm
10mm