

# Gas Safety Products

## Merlin 3000S

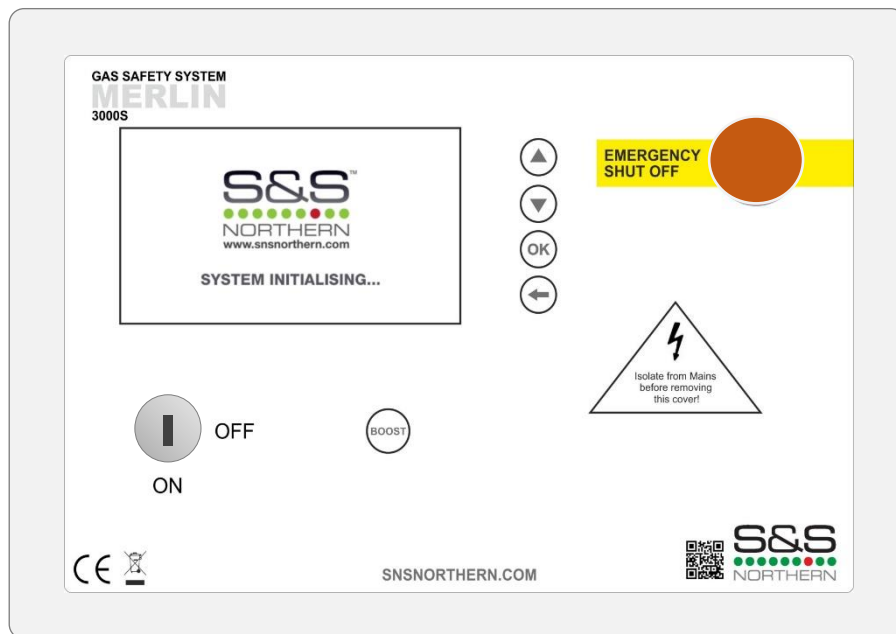

## Installation, operation and maintenance



Read these instructions carefully before operating or servicing

# Contents

- 1 General Information ..... 3**
- 2 Installation ..... 3**
  - 2.1 Positioning ..... 3
  - 2.2 Circuit Board Inputs & Connections ..... 4
  - 2.3 Mains Supply (1) ..... 4
  - 2.4 Solenoid Gas Valve Output (2) ..... 4
  - 2.5 Electric Contactor Output (3) ..... 4
  - 2.6 Fan Current Sensor - Extract & Supply Fan (4) & (5) ..... 5
  - 2.7 BMS Connections Output (6) ..... 5
  - 2.8 Extract & Supply Fan Enable Relay Output (7) & (8) ..... 5
  - 2.9 Gas Pressure Sensor Input (9) ..... 5
  - 2.10 Remote Emergency Shut Off Input (10) ..... 6
  - 2.11 CO Detector Input (11) ..... 6
  - 2.12 CO<sub>2</sub> Zone 1 & 2 : 0-10V Input (12) & (13) ..... 6
  - 2.13 CO<sub>2</sub> Monitor Input (14) ..... 7
  - 2.14 Flow Gas Meter Input (15) ..... 7
  - 2.15 Fire Panel Input (16) ..... 7
  - 2.16 12vDC Output (17) ..... 7
  - 2.17 Smoke/Steam Optical Detection Zone 1-2 Input (18) & (20) ..... 8
  - 2.18 Extract Ductwork Temperature Sensor Input (19) & (21) ..... 8
  - 2.19 0-10VDC Outputs (22) & (23) ..... 9
  - 2.20 Boost Button ..... 9
  - 2.21 Internal Buzzer ..... 9
- 3 Operation Instructions ..... 10**
  - 3.1 How to turn the system on and off ..... 10
  - 3.1.1 Adjusting the Screen Brightness ..... 10
  - 3.2 LED status ..... 10
  - 3.2.1 Power ..... 10
  - 3.3 FAULT Display Screens ..... 11
  - 3.3.1 Emergency Stop ..... 11
  - 3.3.2 CO Detected ..... 11
  - 3.3.3 CO<sub>2</sub> High ..... 12
  - 3.3.4 Fire Alarm Integration ..... 12
  - 3.3.5 Gas Pressure Low ..... 13
  - 3.3.6 Gas Pressure Test Failed ..... 13
  - 3.3.7 Supply Fans ..... 13
  - 3.3.8 Extract Fans ..... 14
  - 3.3.9 Solid Fuel Protection ..... 14
  - 3.4 WARNING Display Screens ..... 15
  - 3.4.1 Boost ..... 15
  - 3.4.2 CO<sub>2</sub> High ..... 15
  - 3.4.3 *USING 0-10V INPUT TERMINALS (12) & (13)* ..... 15
  - 3.4.3 Smoke/Steam Detected ..... 16
  - 3.4.4 Duct Temperature High ..... 16
- 4 Settings and Diagnostic Menu ..... 17**
  - 4.1 SETTINGS Menu ..... 18
  - 4.1.1 Gas Proving ..... 18
  - 4.1.2 Fill Time ..... 18
  - 4.1.3 Prove Time ..... 18
  - 4.1.4 Fan Overrun ..... 19
  - 4.1.5 Auto Reset ..... 19
  - 4.1.6 Emergency Selection ..... 19
  - 4.1.7 BMS Selection ..... 19
  - 4.1.8 Fire Panel Selection ..... 19
  - 4.1.9 Factory Reset ..... 19
  - 4.2 'DIAGNOSTIC' Menu ..... 20
  - 4.2.1 Gas Meter Calibration ..... 20
  - 4.2.2 Solid Fuel Protection ..... 21
  - 4.2.3 Extract Fan Minimum Speed ..... 21
  - 4.2.4 Supply Fan Minimum Speed ..... 21
  - 4.2.5 Extract Fan Enable ..... 21
  - 4.2.6 Supply Fan Enable ..... 21
  - 4.2.7 Factory Reset ..... 21
- 5 3000S Wiring Diagram ..... 22**



**\* The unit should be installed by a competent person only \***

**\* The unit should be stored in cool, dry conditions \***

**\* If the unit is found to be damaged – Contact us \***

## 1 General Information

The Merlin 3000S system is designed to vary the speed of ventilation based on multiple factors; 1) Real-time gas usage via a turbine gas meter; 2) Carbon dioxide (CO<sub>2</sub>) detected levels in the area; 3) Smoke/steam detection within a canopy and 4) Heat detection in the extraction ductwork.

For optimum results and protection-all system sensing elements should be utilised together but any combination can be used.

The Merlin 3000S also carries out its duty as a traditional ventilation interlock and gas pressure proving system alongside the ventilation-on-demand capabilities.

It is recommended that the user reads this guide before installing or operating the Merlin 3000S system.

Please DO NOT attempt to operate the unit until the contents of this document have been read and are thoroughly understood.

### Merlin 3000S Benefits

- ✓ *Interlock with ventilation using Fan Current Sensors or Air Pressure Differential switches*
- ✓ *Optional gas proving function*
- ✓ *Automates ventilation based on real-time gas consumption and CO<sub>2</sub> levels*
- ✓ *Minimises heat loss via extraction by reducing fan speed when gas usage is minimal*
- ✓ *Minimises heat loss via extraction by reducing fan speed when CO<sub>2</sub> levels are minimal*
- ✓ *Pulsed output gas meter can be linked to other Building Management Systems*
- ✓ *Reduced ventilation noise levels at times of low kitchen activity*
- ✓ *Accepts Methane, LPG and CO detection systems*
- ✓ *Covered by the S&S Northern 3 year warranty.*

For more information and a range of gas safety systems, visit our website - [www.snsnorthern.com](http://www.snsnorthern.com)

## 2 Installation

### 2.1 Positioning

<b>3000S Panel</b>	The control panel is designed for surface mounting using 4 mounting screws. Removing the cover on the panel gives access to the circuit board (PCB). <b><i>Remove the PCB before drilling entry holes into the case.</i></b>
<b>CO<sub>2</sub> Monitor</b>	1-3m away from canopy, NOT within 1m of a window and 1.7m from ground level.
<b>CO Detector</b>	1.7m from ground level.
<b>Optical Sensor</b>	Fit inside of canopy. Max 5m from infra-red reflector fitted opposite sensor.

<b>Duct Temp Sensor</b>	Fit inside of ductwork where heat passes through.
<b>Speed Controller</b>	Recommended away from panel to avoid electrical noise.

## 2.2 Circuit Board Inputs & Connections

1 - 3 = HIGH VOLTAGE ONLY

4 - 23 = LOW VOLTAGE ONLY

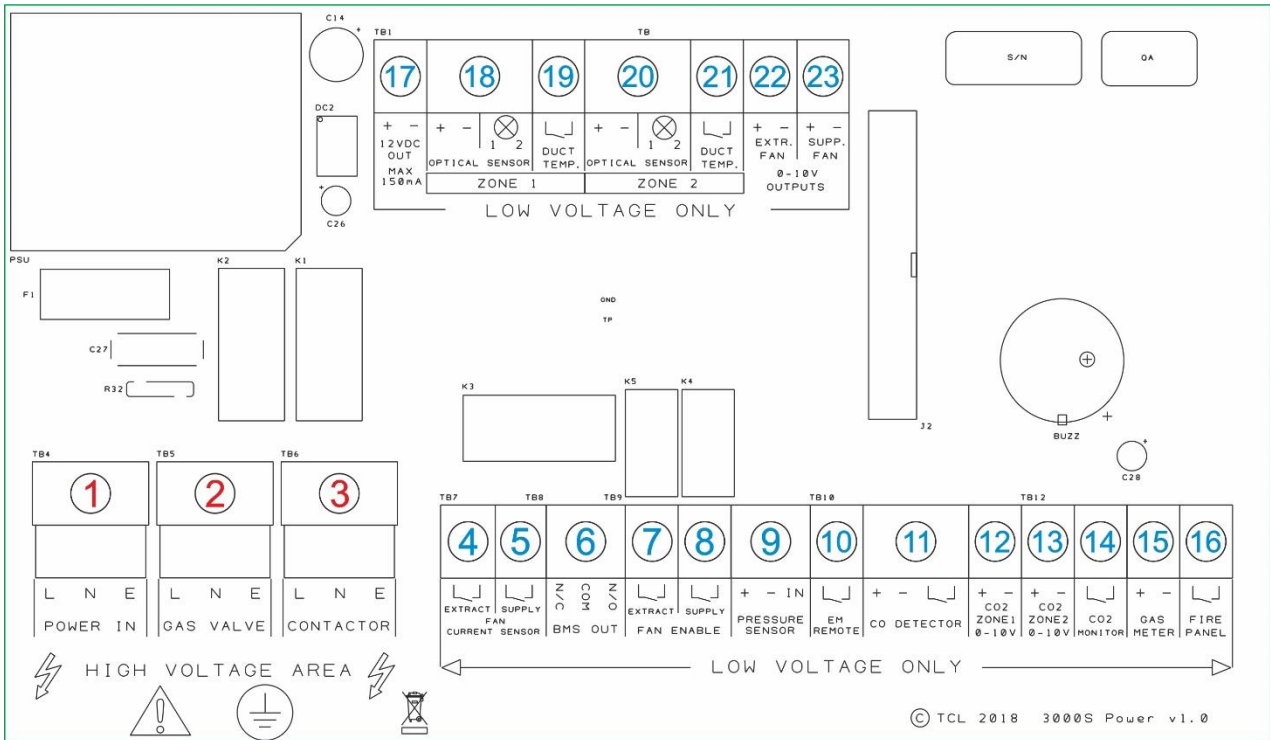

### 2.3 Mains Supply (1)

A 240VAC electrical supply should be supplied to the panel. This should be externally fused at 3 Amps using a fused spur and should be connected to the terminal marked [L N E - POWER IN].

### 2.4 Solenoid Gas Valve Output (2)

The gas solenoid valve should be powered using the terminals on the Merlin 3000S marked [L N E GAS VALVE].

**Maximum current of the valve and Contactor combined should not be loaded over 3 Amps.**

### 2.5 Electric Contactor Output (3)

An electrical output will be supplied to an electrical contactor. This will be internally fused at 3 Amps and should be connected to the terminals marked [L N E CONTACTOR].

**Maximum current of the valve and Contactor combined should not be loaded over 3 Amps.**

**2.6 Fan Current Sensor - Extract & Supply Fan (4) & (5)**

These terminals are used to receive an input signal from external air pressure switches or external current monitors. These are linked out as a factory setting. Wiring to air pressure differential switches and current monitors should be made using two-core volt free connections.

*Terminals not in use should be left with link screwed in. e.g. if only one fan is used.*

**2.7 BMS Connections Output (6)**

Terminals are available on the circuit board for connections to Building Management Systems (BMS). Detailed on the circuit board as [BMS OUT] - [N/C / COM / N/O].

**BMS outputs are Low Voltage Connections - Max 3A**

**2.8 Extract & Supply Fan Enable Relay Output (7) & (8)**

This terminal switches when the key is turned on and off. This can be linked to a fan switch (speed controllers supplied separately) which can provide power to the fans when the control panel is switched on. Can work as N/C or N/O (See example fig.2.0).

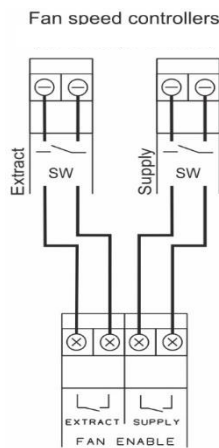

Fig.2.0 Example: Extract & Supply fan speed controller.

**2.9 Gas Pressure Sensor Input (9)**

The terminals are marked [PRESSURE SENSOR] - [+ / - / IN]. Connect to the Gas Pressure Transducer (supplied separately) by screwing into the downstream port on the gas solenoid valve. Please ensure this is wired as instructed (See fig 2.1)

**Minimum Operating Pressure = 12mbar**  
**Maximum Operating Pressure = 100mbar**

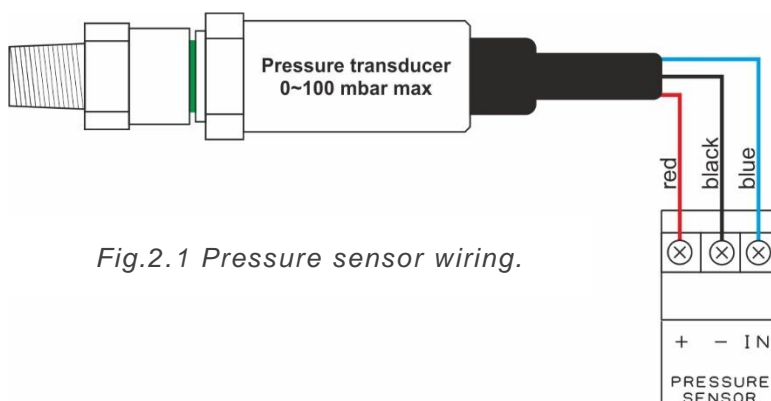



Fig.2.1 Pressure sensor wiring.

**2.10 Remote Emergency Shut Off Input (10)**

The terminal for remote emergency shut-off buttons is detailed on the circuit board as [EM REMOTE]. This connection is linked out as a factory setting.

**Remote emergency shut-off buttons should be volt free and wired using two-core cable.**

**2.11 CO Detector Input (11)**

These connections are [ + / - ] (12VDC) and [  ] and can be wired to a Merlin Carbon Monoxide gas detector (See fig 2.2).

For wiring with a CO<sub>2</sub> Monitor see fig 2.3: CO<sub>2</sub> Monitor - wiring to 3000S panel).

If no detector is being used leave the link in between the “”.

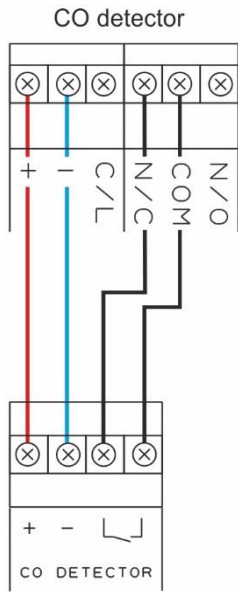

Fig.2.2 CO detector - wiring to 3000S panel.

**2.12 CO<sub>2</sub> Zone 1 & 2 : 0-10V Input (12) & (13)**

Analogue input 0-10VDC signal from CO<sub>2</sub> Monitor will automate speed of extract and supply fans dependant of CO<sub>2</sub> detected levels. For wiring with a CO<sub>2</sub> monitor see fig 2.3.

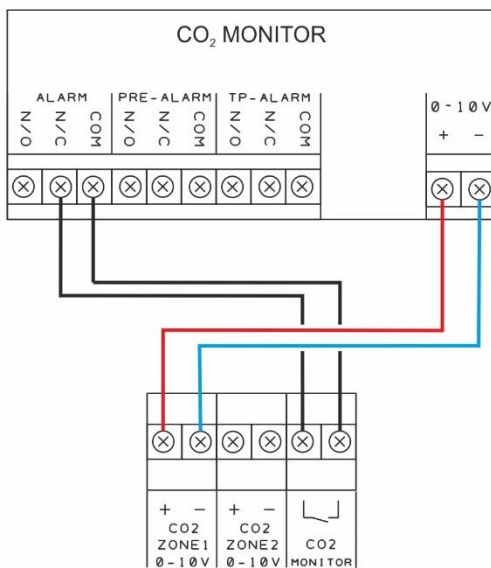

Fig.2.3 CO<sub>2</sub> monitor - wiring to 3000S panel.

### 2.13 CO<sub>2</sub> Monitor Input (14)

The terminals are marked on the circuit board as [CO<sub>2</sub> MONITOR].

These are a linked out connection [⌋] and can be wired to a Merlin Carbon Dioxide Monitor.

For wiring with a CO<sub>2</sub> monitor see *fig 2.3: CO<sub>2</sub> monitor - wiring to 3000S panel*).

If no CO<sub>2</sub> Monitor is being used leave the link in between the “⌋”.

### 2.14 Flow Gas Meter Input (15)

**Before any connections are made, please read the Turbine Gas Meter operation manual.**

The terminals are detailed on the circuit board as [GAS METER]. The connections are [ + / - ]. This is a low voltage connection with a varied pulse input to drive fans on an automatic varied speed based on real-time gas usage.

TBX – Turbine Gas Meter has two types of pulse output – 'unit pulse' and 'high density pulse'. The Merlin 3000S requires a HIGH density pulse wire. (See *fig. 2.4*)

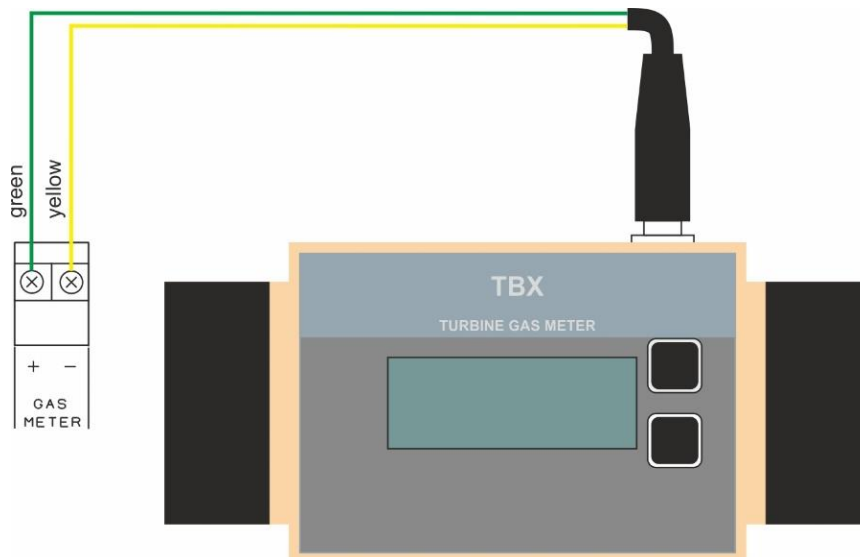

*Fig.2.4 Gas meter wiring.*

### 2.15 Fire Panel Input (16)

The terminal for fire alarms is detailed on the circuit board as [FIRE PANEL]. These connections are linked out as a factory setting.

**Fire alarms should be volt free using two-core cable. Normally closed, open on activation.**

### 2.16 12vDC Output (17)

This is a permanent 12vDC output (max loading 150mA/~2W) when there is power at the panel. This is normally used to power a Merlin PM2+ Current Monitor (supplied separately).

### 2.17 Smoke/Steam Optical Detection Zone 1-2 Input (18) & (20)

The terminals detailed on the circuit board as [OPTICAL SENSOR] - [ + / - ] [ 1 / 2 ]. These wire to the optical sensor (supplied separately). (See Fig. 2.5)

- "+" Brown (positive +12V)
- "-" Blue (negative GND)
- "1" White (GND)
- "2" Black (drive signal 0V or 11.2V).

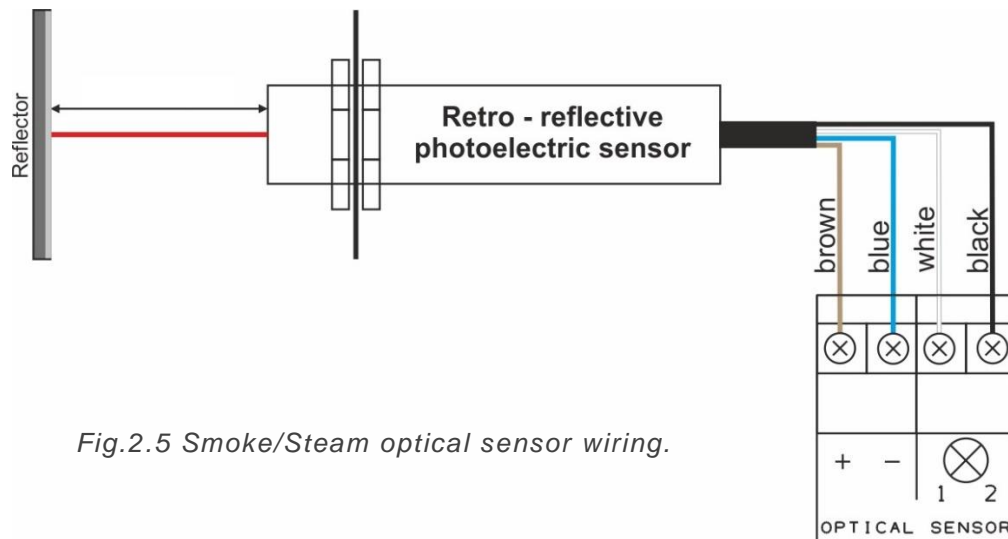

### 2.18 Extract Ductwork Temperature Sensor Input (19) & (21)

The terminals are detailed on the circuit board as [DUCT TEMP]. This is a low resistance connection to the duct temperature sensor to drive fans on an automatic varied speed based on extraction duct temperature levels. (See Fig. 2.6)

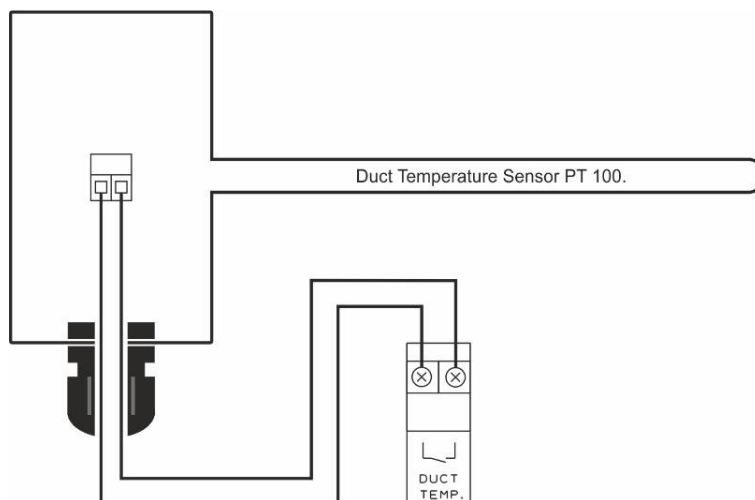



## 2.19 0-10VDC Outputs (22) & (23)

The terminals for the 0-10VDC outputs are detailed on the circuit board as [EXTR. FAN] & [SUPP. FAN]. These connections are used to regulate external fan speed controllers (supplied separately) which can accept this control signal. (See example Fig. 2.7)

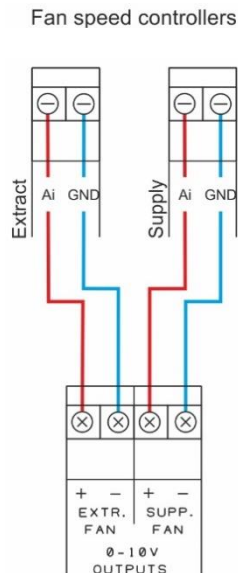

Fig.2.7 Example. Extract & Supply 0-10V output to fan speed controller.

## 2.20 Boost Button

To boost the ventilation and prompt maximum fan speed - Press and Release the [Boost] button located on front fascia. '1' or '10' minute mode will be displayed and the pre-selected time will countdown in minutes. When BOOST time reaches zero, the fans will automatically return to normal operation mode.

To turn boost off - Press and Release the [Boost] button located on front fascia. System will back to normal operation mode.

## 2.21 Internal Buzzer

Operates at approx 65dB measured 30cm from closed panel.

### Note:

**All low voltage connections should be made using a screened cable to avoid electrical interference and should not be in the same conduit as per the low voltage directive.**

### 3 Operation Instructions

#### 3.1 How to turn the system on and off

1. To turn the unit ON - Turn the key switch to ON position.
2. To turn the unit OFF - Turn the key switch to the OFF position.

Under normal conditions - Display will show speed of fans (*fig. 3.0*).

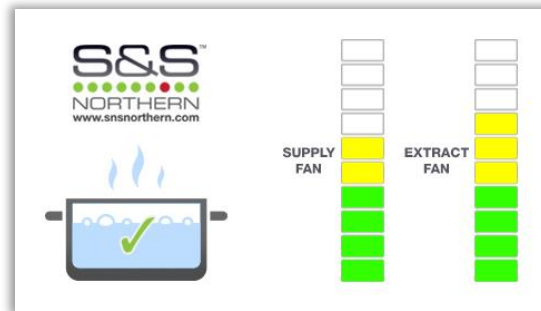

*Fig.3.0 System OK.*

When the 3000S is turned off and 'Fan Overrun Time' from menu was selected the display will countdown to when the fans will switch off (*fig 3.1*). To deactivate - press emergency button or switch key ON.



*Fig.3.1 Fan Overrun Time*

#### 3.1.1 Adjusting the Screen Brightness

Hold the UP ▲ button on the front panel for ~3 seconds until the panel beeps. Press UP to select three brightness levels (High / Medium / Low). Once you have selected your desired brightness, leave the panel for ~5 seconds and the brightness will be set.

#### 3.2 LED status

##### 3.2.1 Power

When the system is connected to the mains supply, the RED LED of the S&S Logo located in the bottom right corner of the panel will illuminate. When no power is present, this LED will not be lit.

RED LED = ON

RED LED OFF = No Power. *Note: a loose ribbon connection or the fuse may not be intact.*

### 3.3 FAULT Display Screens

#### 3.3.1 Emergency Stop

If an emergency stop button (remotely or direct) is pressed, the gas and contactor will be turned off and the display will show fault (*fig. 3.2*).

Fans can be driven in any of 4 combination– (*see settings menu chapter*).

The Emergency Stop button must be reset before restarting the system.

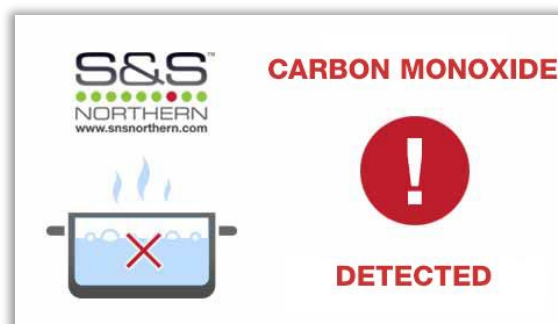

*Fig.3.2 Emergency Stop fault display screen.*

#### 3.3.2 CO Detected

If the connected CO Detector detects gas. The fault screen (*fig 3.3*) will show.

The gas and contactor will be turned off and fans will run at maximum speed.



*Fig.3.3 CO detected fault display screen.*

### 3.3.3 CO<sub>2</sub> High

- **USING CO<sub>2</sub> MONITOR INPUT TERMINALS (14)**

When CO<sub>2</sub> gases rise above alarm level (see CO<sub>2</sub> Monitor manual) the fault screen (fig 3.4) will appear.

The gas and contactor will be turned off and fans will run at maximum speed.



Fig.3.4 CO<sub>2</sub> detected fault display screen.

### 3.3.4 Fire Alarm Integration

If the connected fire panel detects fire. The fault screen (fig 3.5) will appear.

The gas and contactor will be turned off.

Fans can be driven in any 4 combinations – (see settings menu chapter).



Fig.3.5 Fire alarm activated display screen.

### 3.3.5 Gas Pressure Low

When gas supply pressure drops below 12mBar for 10 seconds. The fault screen (*fig 3.6*) will appear and the gas valve, contactor and the fans will turn OFF.



*Fig.3.6 Low gas pressure display screen.*

### 3.3.6 Gas Pressure Test Failed

If the gas pressure test drops by more than 10% or below 12mBar the test will fail (*fig 3.7*).



*Fig.3.7 Gas pressure test fail display screen.*

### 3.3.7 Supply Fans

Under normal operation, if a supply fan fault is detected. The fault screen (*fig 3.8*) will appear and the gas, contactor and the fans will be turned off.

**GAS WILL SHUT OFF IF SUPPLY/ EXTRACT FAN/S FAULT FOR MORE THAN 20 SECONDS**



*Fig.3.8 Supply fan fault display screen.*

### 3.3.8 Extract Fans

Under normal operation, if an extract fan fault is detected. The fault screen (*fig 3.9*) will appear and the gas, contactor and the fans will be turned off.

*GAS WILL SHUT OFF IF SUPPLY/ EXTRACT FAN/S FAULT FOR MORE THAN 20 SECONDS*



*Fig.3.9 Extract fan fault display screen.*

### 3.3.9 Solid Fuel Protection

The Merlin 3000S has a built-in solid fuel protection feature. This is factory set to OFF.

During when the system is switched off and the solid fuel protection is set to ON it will instruct the system to continue to check: CO Detector ([11](#)) CO<sub>2</sub> Monitor ([14](#)) & Duct Temperature ([19 & 21](#)).

If any of the above will go into alarm, the 3000S will drive fans at maximum speed and will display the relevant fault displays:

CO Detector (*Fig.3.3*).

CO<sub>2</sub> Monitor (*Fig.3.4*).

Duct Temperature (*Fig.3.10*) See below.

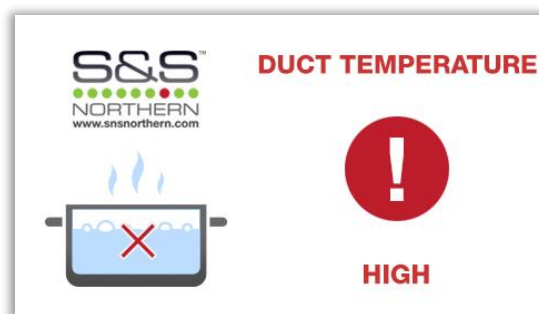

*Fig.3.10 Duct temperature high display screen.*

When all of the above will drop to safety levels the system will automatically shut down again.

When the alarm EM Stop buttons are activated, the warning screen (*fig 3.2*) will appear and the fans can be driven in any four combinations – (*see settings menu chapter*).

### 3.4 WARNING Display Screens

#### 3.4.1 Boost

When BOOST option is selected, the warning screen (*fig 3.11*) will appear and the fan/s will operate at maximum speed.

'01' or '10' minute mode will be displayed and the pre-selected time will countdown in minutes.

When boost time reaches zero, the fans will automatically return to normal operation.

To turn boost off - press and release the [Boost] button and the system will return to normal operation.



*Fig.3.11 Boost activated display screen.*

#### 3.4.2 CO<sub>2</sub> High

##### **USING 0-10V INPUT TERMINALS (12) & (13)**

When CO<sub>2</sub> gas is detected above alarm level (see CO<sub>2</sub> Monitor manual) the screen (*fig 3.12*) will appear and the fans will drive at maximum speed.

When the CO<sub>2</sub> gas returns below alarm level, the system will return to normal operation.

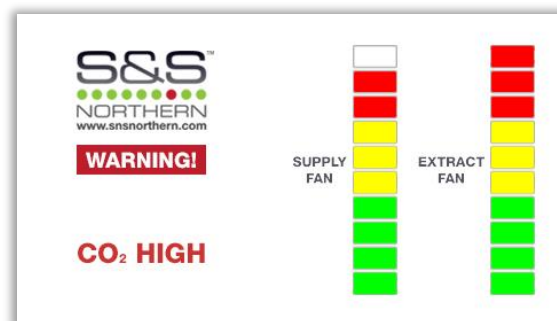
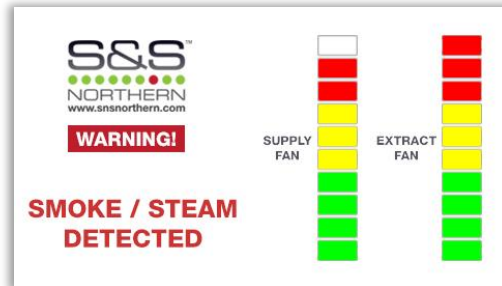

*Fig.3.12 CO<sub>2</sub> high warning display screen.*

### 3.4.3 Smoke/Steam Detected

When smoke or steam is detected continuously for ~3 seconds, the warning screen (*fig 3.13*) will appear and the fans will operate at maximum speed.

When smoke or steam is not detected continuously for ~5 seconds the system will automatically return to normal.



*Fig.3.13 Smoke / steam detected warning display screen.*

When smoke or steam is detected for longer than 30minutes, the panel will buzz intermittently and the warning screen (*fig 3.14*) will appear to prompt cleaning the optical sensors.

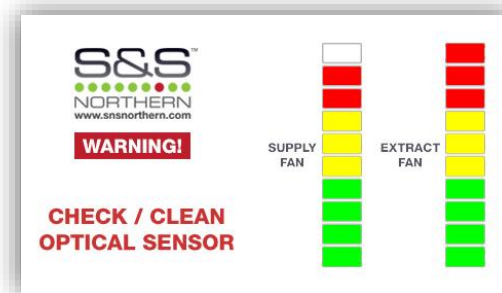

*Fig.3.14 Check / Clean Optical Sensor display screen.*

### 3.4.4 Duct Temperature High

When the temperature in the extraction duct reaches or rises above 30°C, the fans will be driven at a speed dependant on the temperature. When the temperature in the extraction duct reaches or rises above 73°C, the warning screen (*fig 3.15*) will appear and the fans will be driven at maximum speed.

When the temperature in the extraction duct drops below 73°C, the warning screen (*fig 3.15*) will disappear and the fans will continue at a speed dependant on the temperature.

When the temperature drops below 30°C, system will automatically return to normal.



*Fig.3.15 Duct temperature high warning.*



## 4 Settings and Diagnostic Menu

### How to prompt SETTINGS menu - Open Panel

- 1 Ensure the [DIAGNOSTIC DIP SWITCH] is OFF.
- 2 Turn key switch OFF.
- 3 Located on the display board is [SETTINGS DIP SWITCH] - Switch it ON.
- 4 Turn key switch to ON.

GAS PROVING	OFF
FILL TIME	5
PROVE TIME (sec.)	30
FAN OVERRUN (min.)	OFF
AUTO RESET	OFF
EMERGENCY SELECTION	FANS OFF
BMS SELECTION	OFF
FIRE PANEL SELECTION	FANS OFF

Fig.4.0a Settings menu page 1.

BOOST TIME (min.)	1
FACTORY RESET	

Fig.4.0b Settings menu page 2

### How to prompt DIAGNOSTIC menu - Open Panel

- 1 Ensure the [SETTINGS DIP SWITCH] is OFF.
- 2 Turn key switch OFF.
- 3 Located on the display board is [[DIAGNOSTIC DIP SWITCH] - Switch it ON.
- 4 Turn key switch to ON.

GAS METER CALIBRATION	-
SOLID FUEL PROTECTION	OFF
EXTRACT FAN MIN SPEED	5
SUPPLY FAN MIN SPEED	5
EXTRACT FAN ENABLE	NC
SUPPLY FAN ENABLE	NC
FACTORY RESET	

Fig.4.1 Diagnostic menu default settings.

Navigate the Menu with four push buttons located on front fascia.

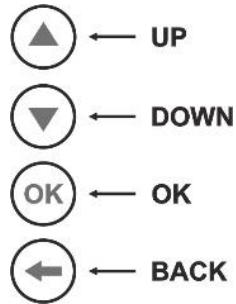

Fig.4.2 Navigation buttons.

### How to change settings

Use ▲ or ▼ to select function - *selection highlighted green.*

**EXTRACT FAN MIN SPEED** 5

Press OK button - *green frame will change to red.*

**EXTRACT FAN MIN SPEED** 5

Use ▲ or ▼ to select appropriate value.

**EXTRACT FAN MIN SPEED** 7

Press OK button and wait until red frame returns to green.

**EXTRACT FAN MIN SPEED** 7

## 4.1 SETTINGS Menu

### 4.1.1 Gas Proving

This is factory set to OFF (proving disabled). If you do require gas pressure proving this can be enabled by selecting ON.

### 4.1.2 Fill Time

Fill time is factory set to 5 seconds. This can be set to 5, 10, 15 or 20 seconds.

### 4.1.3 Prove Time

Prove time is factory set at 30 seconds. This can be set to 30, 45, 60, 75 or 90 seconds.

#### 4.1.4 Fan Overrun

The Merlin 3000S has an option for cooling the duct for a period of time when the system is switched off by key.

Fan Overrun can be set to OFF (factory set) or continue to run from a period of 1 to 30 minutes.

All input and outputs will be switched off and only the fans will remain in operation.

#### 4.1.5 Auto Reset

The Merlin 3000S has a built-in auto-reset feature. This is factory set to OFF.

In the event of a power cut the panel has to be restarted manually by key switch.

When auto-reset is configured ON it will instruct the system to restart automatically when power is restored.

#### 4.1.6 Emergency Selection

The Merlin 3000S has a FOUR combination emergency selection feature:

**FANS OFF** - Extract & Supply fan OFF (default).

**FANS ON** - Extract & Supply fan ON at maximum speed.

**SUPP ON** – Extract fan is OFF / Supply fan ON at maximum speed.

**EXTR ON** – Supply fan is OFF / Extract fan ON at maximum speed.

Each option instructs the system to shut down the gas supply and contactor when Emergency Stop buttons are activated.

#### 4.1.7 BMS Selection

The Merlin 3000S can be integrated with a Building Management System (BMS) to make or break a circuit on Gas ON/OFF (valve open or valve closed).

This will tell the BMS whether or not the room has gas supply.

This is factory set to OFF which signals the BMS on Gas ON/OFF.

This can be switched to ON if required where the 3000S will signal the BMS on a fault, *i.e. High CO<sub>2</sub> level detected, Gas detected, Emergency stop pressed, etc.*

#### 4.1.8 Fire Panel Selection

The Merlin 3000S has a FOUR combination fire panel selection feature:

**FANS OFF** - Extract & Supply fan OFF (default).

**FANS ON** - Extract & Supply fan ON at maximum speed.

**SUPP ON** – Extract fan is OFF / Supply fan ON at maximum speed.

**EXTR ON** – Supply fan is OFF / Extract fan ON at maximum speed.

Each option instructs the system to shut down gas supply and contactor on activation by Fire Panel.

#### 4.1.9 Factory Reset

All settings from the 'settings' menu can be restored to default (*see fig.4.0*).

## 4.2 'DIAGNOSTIC' Menu

### 4.2.1 Gas Meter Calibration

Select [GAS METER CALIBRATION] option. (fig 4.3).

- Fans start operating at maximum speed and the gas valve will open.
- Turn all appliances on and set gas to maximum.
- When all appliances are ready - press OK.
- The calibration can take from a few seconds to 3 minutes depending on the gas consumption.



Fig.4.3 Gas meter calibration.

- The Merlin 3000S will then confirm successful calibration (fig 4.4).

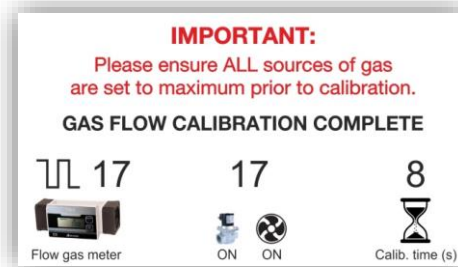
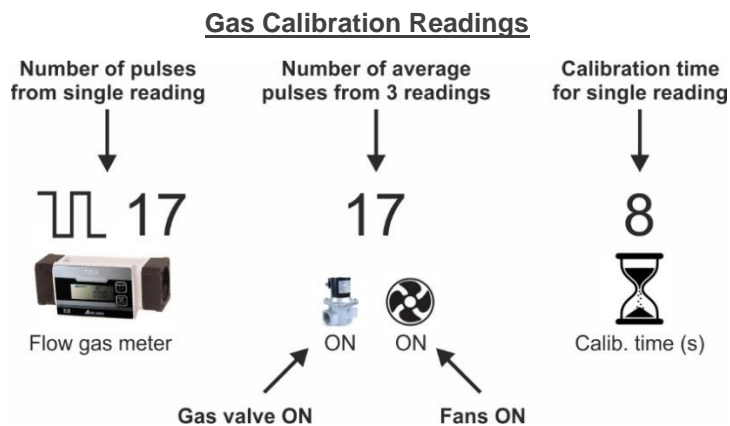
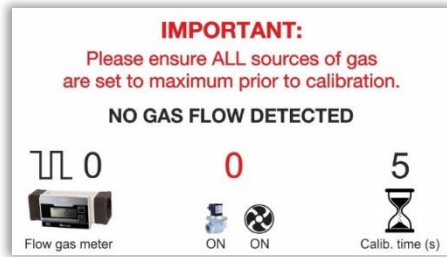

Fig.4.4 Gas meter successful calibration.



- If the system encounters a calibration fault - display will show either (*fig 4.5 and fig 4.6*).



*Fig.4.5 not enough pulses.*

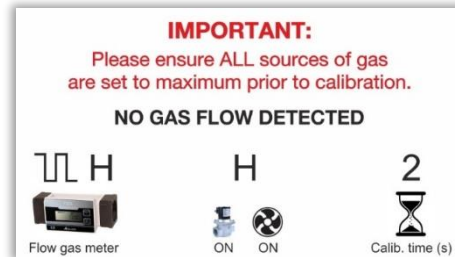

*Fig.4.6 too many pulses.*

The 3000S will automatically increase calibration time (seconds) when it receives less than 12 pulses within 5 seconds and decreases calibration time when receiving more than 999 pulses within 5 seconds.

Successful calibration is possible only when the 3000S receives between 12 to 998 pulses within 2 to 60 seconds.

The system will measure three times the number of pulses and save an average value. The calibration time will have an influence on the fan speed response time in relation to CO<sub>2</sub> value and duct temperature.

#### 4.2.2 Solid Fuel Protection

The Merlin 3000S has a built-in solid fuel protection feature. This is factory set to OFF.

When the 3000S is switched OFF and solid fuel protection is set to ON it will instruct the system to continue to check the CO Detector (11), CO<sub>2</sub> Monitor (14) and Duct Temperature (19 & 21).

#### 4.2.3 Extract Fan Minimum Speed.

It is possible to setup the minimum speed for extract fan ranging from 1 – 10 volts/ bars (*default 5*).

#### 4.2.4 Supply Fan Minimum Speed.

It is possible to setup minimum speed for supply fan in range from 1 – 9 volts/bars \* (*default 5*).

**\*WE DO NOT RECOMMEND A SUPPLY FAN SPEED HIGHER THAN EXTRACT FAN SPEED.**

#### 4.2.5 Extract Fan Enable

The Merlin 3000S has a built-in fan speed control - ON/OFF feature. This can work as N/O or N/C (NC default).

#### 4.2.6 Supply Fan Enable

The Merlin 3000S has a built fan speed control - ON/OFF feature. This can work as N/O or N/C (NC default).

#### 4.2.7 Factory Reset

All settings from the 'diagnostic' menu can be restored to default (*see fig.4.1*).

## 5 3000S Wiring Diagram

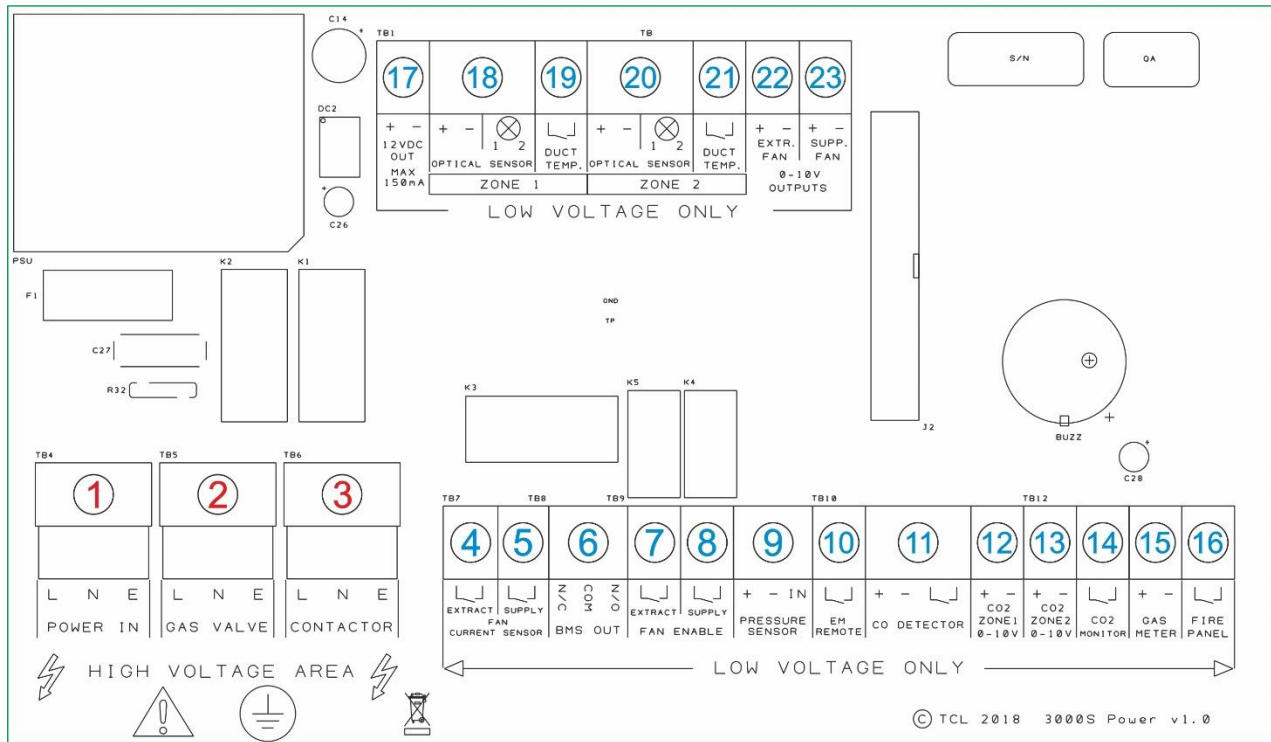

3000S Circuit Board Terminals.

1. **HIGH VOLTAGE OUTPUT** Mains Input 230V Single Phase.
2. **HIGH VOLTAGE OUTPUT** Gas solenoid valve power output, 230VAC, Max 3A (see .2.3).
3. **HIGH VOLTAGE OUTPUT** Electric contactor power output, 230VAC, Max 3A (see .2.4).
4. Extract fan current switch or pressure differential switch. **VOLT FREE INPUT**
5. Supply fan current switch terminal, this is disabled on this system. **VOLT FREE INPUT**
6. BMS output contacts. Normally Closed, Common and Normally Open. Max.3A
7. Extract fan enable relay output to fan speed controller. Max 0.5A
8. Supply fan enable relay output to fan speed controller. Max 0.5A
9. Gas pressure transducer, Red + positive, Black – negative and Blue IN.
10. Remote EM Stop buttons. **VOLT FREE INPUT**
11. CO Detector power supply and **volt free input** (purchased separately). **VOLT FREE INPUT**
12. Analogue signal 0-10VDC input zone 1.
13. Analogue signal 0-10VDC input zone 2.
14. CO<sub>2</sub> Monitor input (purchased separately). **VOLT FREE INPUT**
15. Turbine gas meter input. This is a low voltage connection with a varied pulsed input.
16. Fire panel (Supplied by others). **VOLT FREE INPUT**
17. Permanent 12VDC output (Normally used to power a PM2+ Current Monitor).
18. Optical sensor input zone 1. Smoke /steam detection.
19. Ductwork temperature sensor input zone 1. **VOLT FREE INPUT**
20. Optical sensor input zone 2. Smoke / steam detection.
21. Ductwork temperature sensor input zone 2. **VOLT FREE INPUT**
22. 0-10VDC output to external extract fan speed controllers.
23. 0-10VDC output to external supply fan speed controllers.

Please note, Mains wires and low voltage wires should not be run in the same conduit as per the **LOW VOLTAGE DIRECTIVE**

## Specification

<b>Model</b>	Merlin 3000S
<b>Power Supply</b>	100-240VAC, 50-60Hz
<b>Power Consumption</b>	6.9 W
<b>Maximum Current</b>	28mA
<b>BMS Output</b>	Max 3A
<b>Extract &amp; Supply Fan Enable Output</b>	Max Current: 0.5A
<b>Model Weight (g)</b>	1282
<b>Model Dimensions (mm)</b>	W 255 x H 180 x D 77
<b>Standard Approval</b>	CE / RoHS

**INFORMATION ON WASTE DISPOSAL FOR CONSUMERS OF ELECTRICAL & ELECTRONIC EQUIPMENT**

When this product has reached the end of its life it must be treated as Waste Electrical & Electronics Equipment (WEEE). Any WEEE marked products must not be mixed with general household waste, but kept separate for the treatment, recovery and recycling of the materials used. Please contact your supplier or local authority for details of recycling schemes in your area.

**CONTACT US:****S&S Northern Head Office**

Tel: +44(0) 1257 470 983

Fax: +44(0) 1257 471 937

[www.snsnorthern.com](http://www.snsnorthern.com)

[info@snsnorthern.com](mailto:info@snsnorthern.com)

**South East Division**

Tel: +44(0) 1702 291 725

Fax: +44(0) 1702 299 148

[www.snsnorthern.com](http://www.snsnorthern.com)

[south@snsnorthern.com](mailto:south@snsnorthern.com)

S&S Northern is the owner of this document and reserves all rights of modification without prior notice.