





Tel/fax: 01367 710050

Email: rob@aluman.co.uk

Web: www.aluminiumltd.co.uk

Company Number – 7229969

VAT Number – 990 687 367

Type 2e

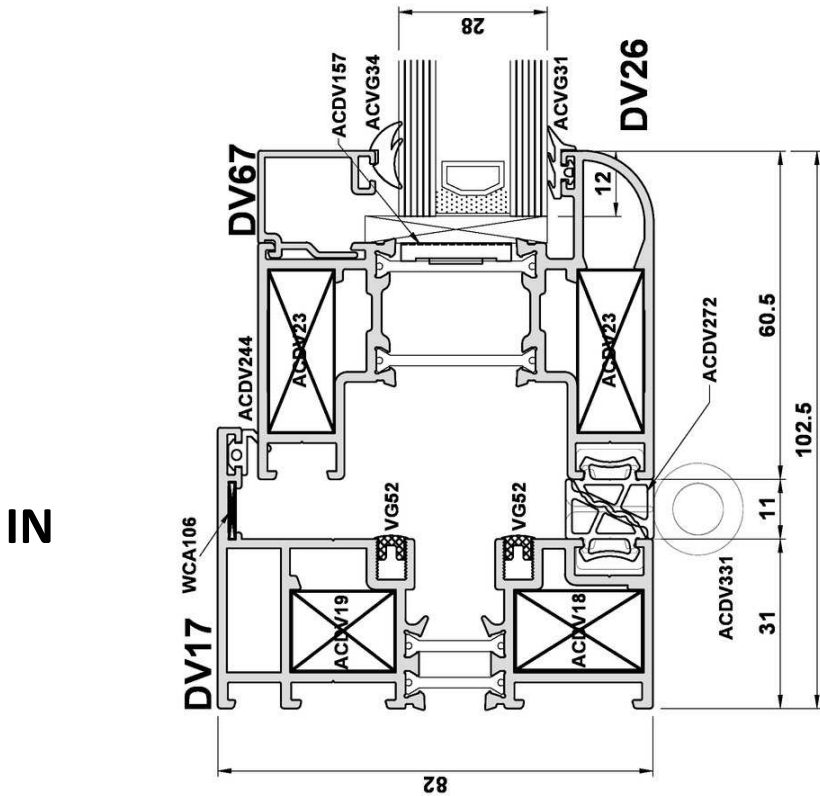
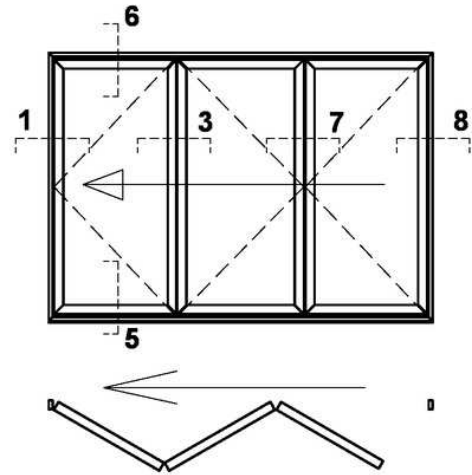

OUT

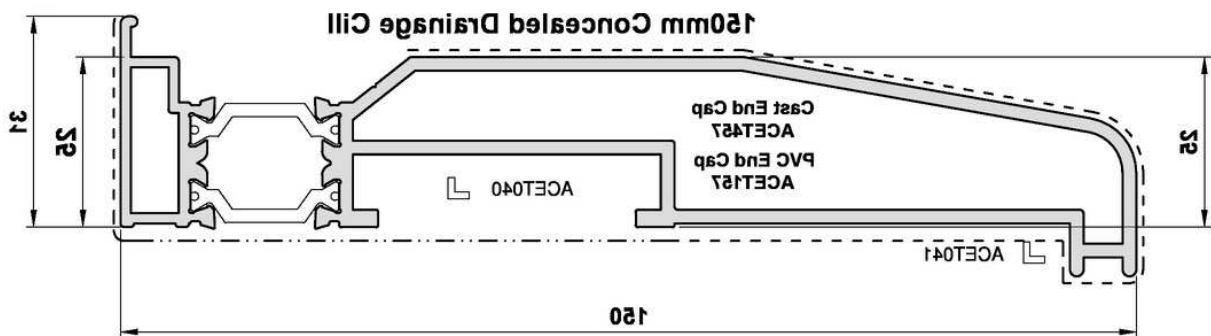

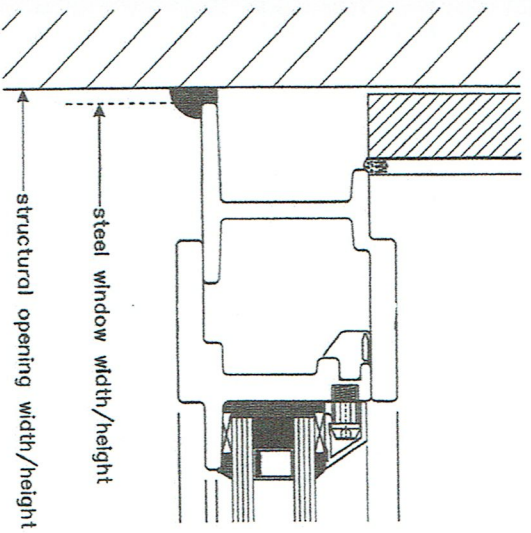

TOP HUNG TO STRUCTURE

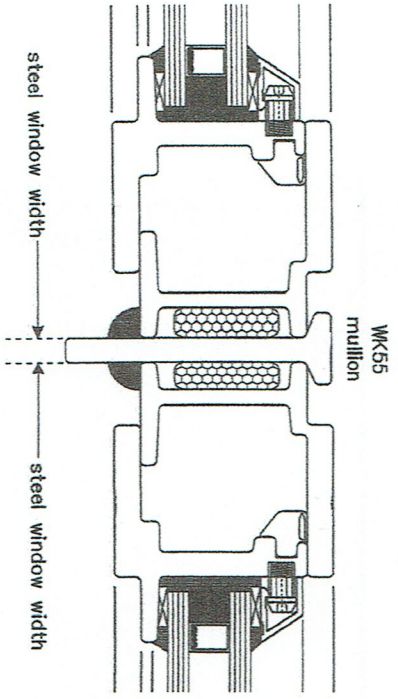

TOP HUNG COUPLED TO TOP HUNG

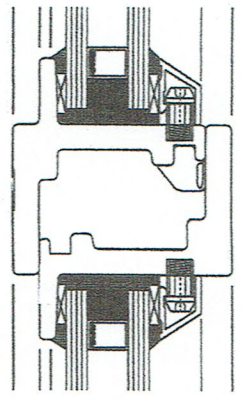

DOUBLE DOOR MEETING STILE

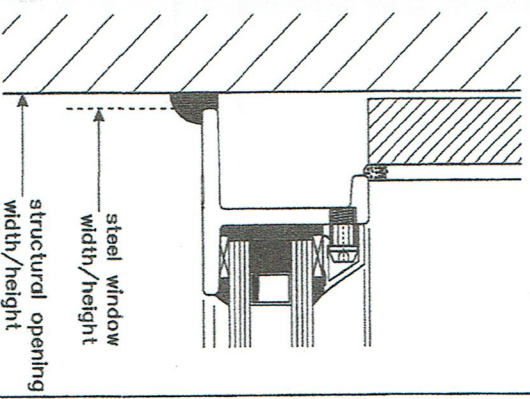

FIXED LIGHT TO STRUCTURE

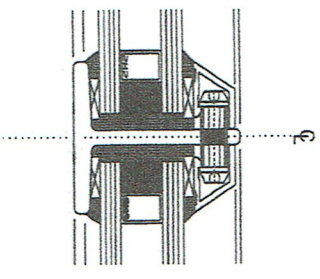

GLAZING BAR

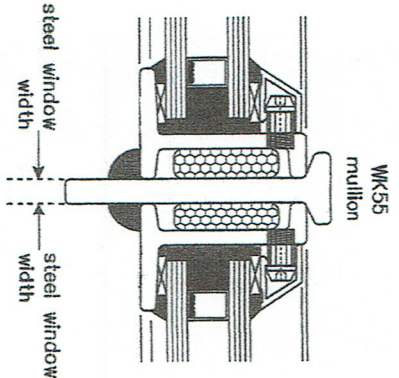

FIXED LIGHT COUPLED TO FIXED LIGHT

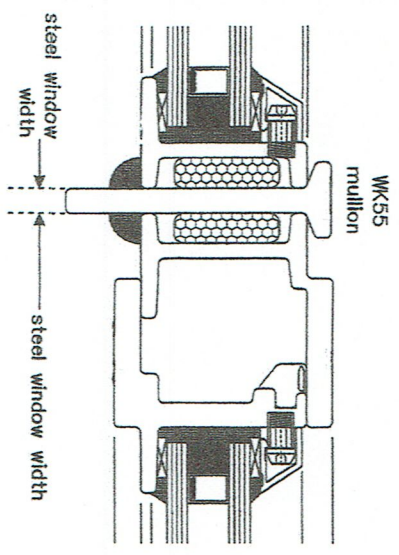

FIXED LIGHT COUPLED TO DOOR

Scale 1 : 1 @ A3

Drawn

Checked

Date

Project

Title

Section Details

Drawing No.

Revisions

Approved for manufacture

Client /

Date :

All dimensions in millimetres unless stated otherwise.
All elevations drawn from the outside unless otherwise stated.
Do not scale - A3 Original

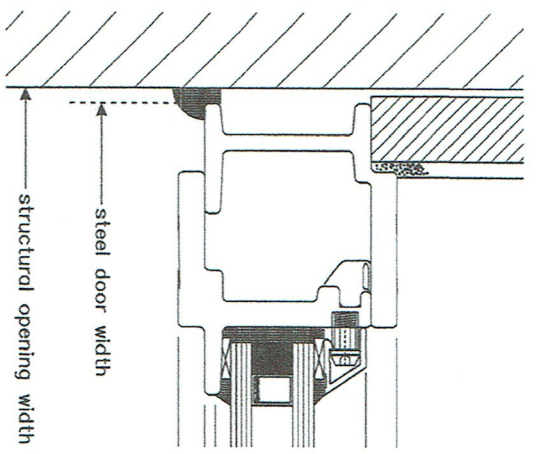

DOOR JAMB TO STRUCTURE

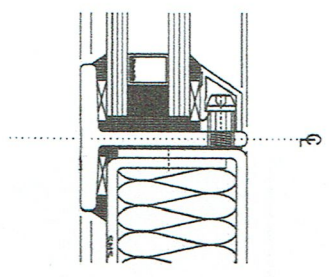

GLAZING BAR WITH LOCK PANEL

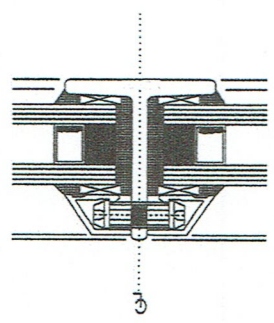

GLAZING BAR

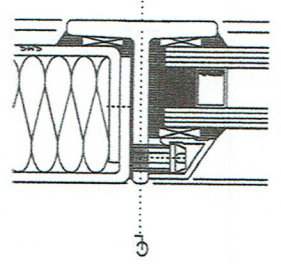

GLAZING BAR WITH KICK PANEL

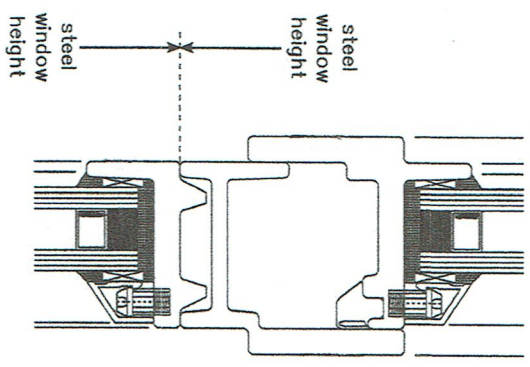

DIRECT COUPLING

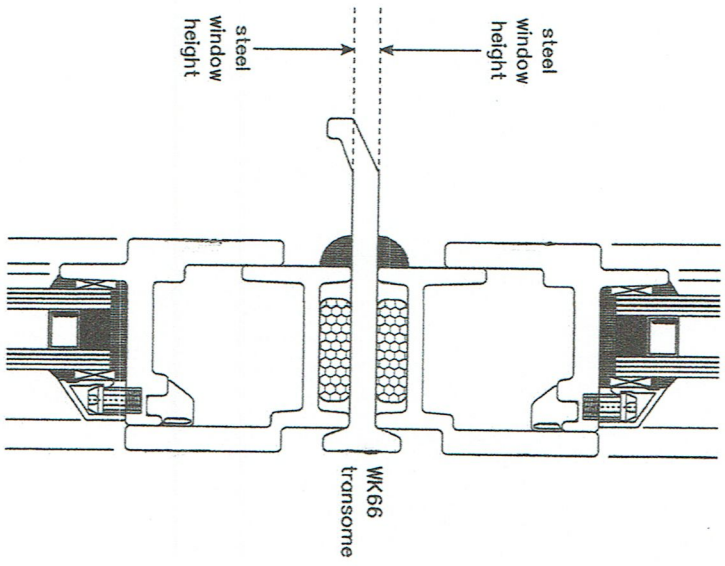

TOP HUNG COUPLED TO DOOR

Scale 1 : 1 @ A3

Drawn _____

Checked _____

Date _____

Project _____

Title _____

Section Details

Drawing No. _____

Revisions

Approved for manufacture

Client / _____

Date : _____

All dimensions in millimetres unless stated otherwise.
All elevations drawn from the outside unless otherwise stated.
Do not scale - A3 Original