

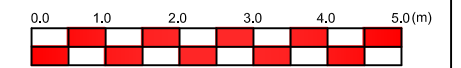

THIS DRAWING IS COPYRIGHT and must not be traced or reproduced in any way of form in part or whole by any means whatsoever without written consent from Lotus Engineers Ltd. This drawing may be copied by authorised officer of the Local Authority to assess the planning or building regulation application.

NOTES:

- DIMENSIONS ARE IN CENTIMETRE UNLESS NOTED OTHERWISE.



SITE:
263 Mays Ln, Barnet EN5 2LY

PROJECT NAME:
FIRST STOREY REAR EXTENSION

DRAWING TITLE:
LOCATION MAP

DRAWING NO.:
LCENG-401-263-EN52LY

STATUS:
PLANNING

DATE	26/04/2021	REV	0	DRAWN	AM
SCALE	1:1250	SIZE	A3	SHEET	1 OF 5



336 Bellards Ln, North Finchley, London N12 0EY
T: 020 8123 1070
E: info@LCENG.co.uk
W: www.LCENG.co.uk

THIS DRAWING IS COPYRIGHT and must not be traced or reproduced in any way of form in part or whole by any means whatsoever without written consent from Lotus Engineers Ltd. This drawing may be copied by authorised officer of the Local Authority to assess the planning or building regulation application.

NOTES:

- DIMENSIONS ARE IN CENTIMETRE UNLESS NOTED OTHERWISE.

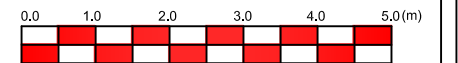
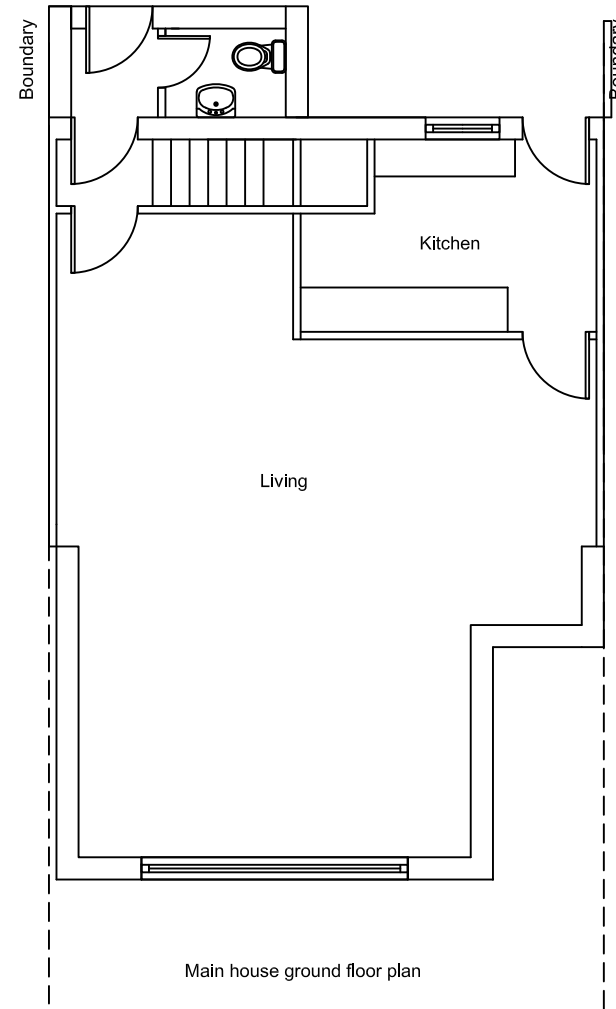

SITE:
263 Mays Ln, Barnet EN5 2LY

PROJECT NAME:
OUT BUILDING

DRAWING TITLE:
MAIN BUILDING GROUND FLOOR PLAN

DRAWING NO.:
LCENG-401-263-ENG2LY

STATUS:
PLANNING

DATE	26/04/2021	REV	0	DRAWN	AM
SCALE	1:100	SIZE	A3	SHEET	2 OF 5



336 Ballards Ln, North Finchley, London N12 0EY
T: 020 8123 1070
E: info@LCENG.co.uk
W: www.LCENG.co.uk

THIS DRAWING IS COPYRIGHT and must not be traced or reproduced in any way of form in part or whole by any means whatsoever without written consent from Lotus Engineers Ltd. This drawing may be copied by authorised officer of the Local Authority to assess the planning or building regulation application.

NOTES:

- DIMENSIONS ARE IN CENTIMETRE UNLESS NOTED OTHERWISE.

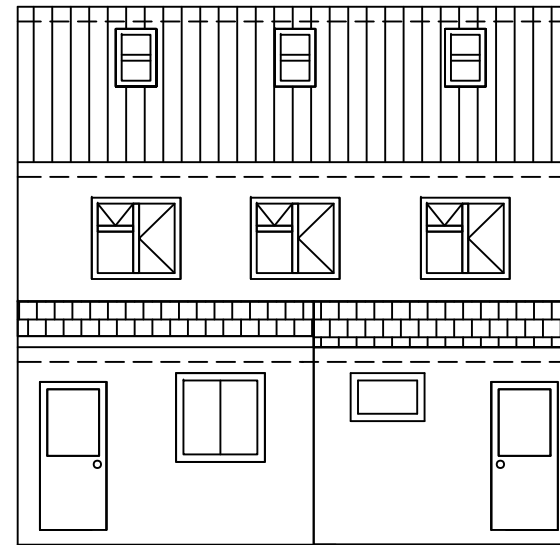

EXISTING FRONT ELEVATION

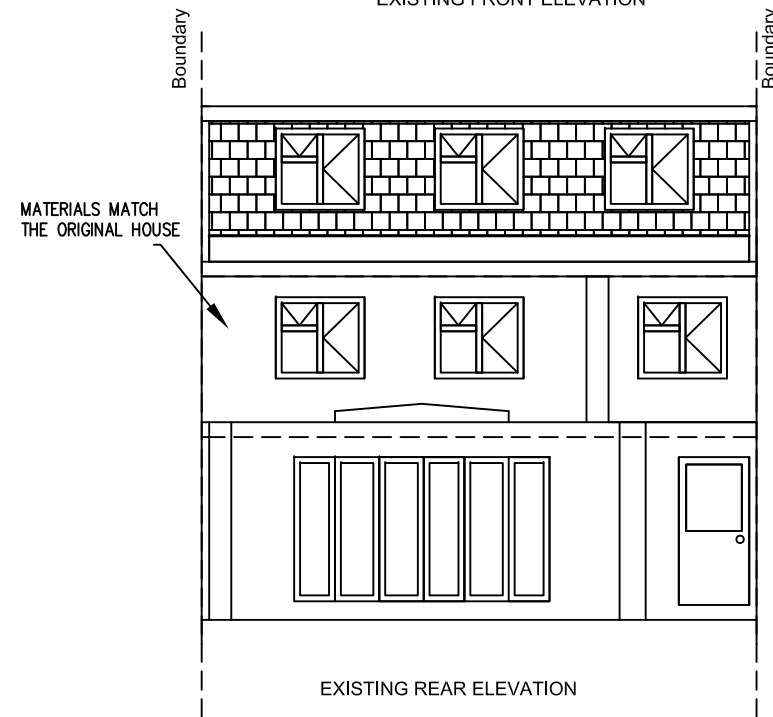

EXISTING REAR ELEVATION

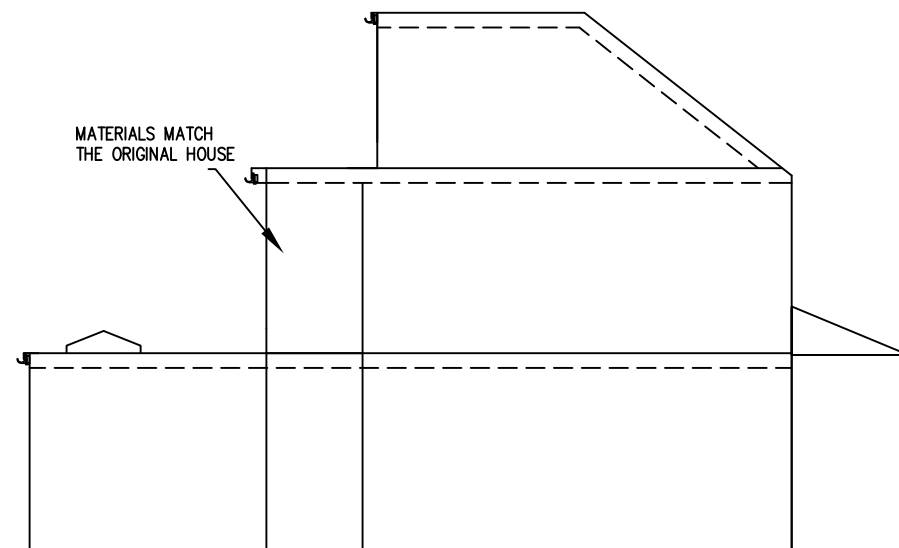

EXISTING SIDE ELEVATION

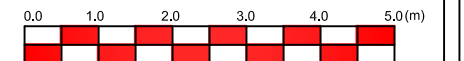

SITE:
263 Mays Ln, Barnet EN5 2LY

PROJECT NAME:
OUT BUILDING

DRAWING TITLE:
MAIN BUILDING ELEVATIONS

DRAWING NO.:
LCENG-401-263-ENG2LY

STATUS:
PLANNING

DATE	26/04/2021	REV	0	DRAWN	AM
SCALE	1:100	SIZE	A3	SHEET	3 OF 5



336 Bellards Ln, North Finchley, London N12 0EY
T: 020 8123 1070
E: info@LCENG.co.uk
W: www.LCENG.co.uk

THIS DRAWING IS COPYRIGHT and must not be traced or reproduced in any way of form in part or whole by any means whatsoever without written consent from Lotus Engineers Ltd. This drawing may be copied by authorised officer of the Local Authority to assess the planning or building regulation application.

NOTES:

- DIMENSIONS ARE IN CENTIMETRE UNLESS NOTED OTHERWISE.

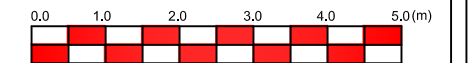
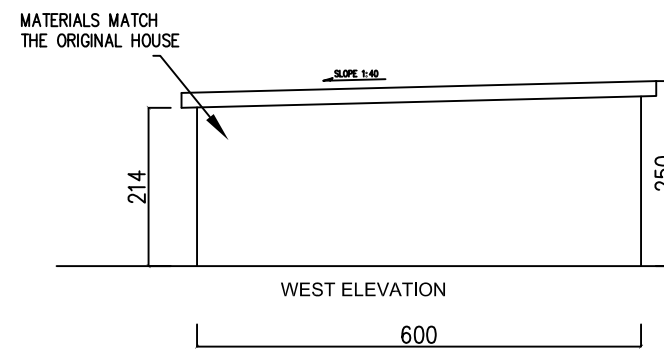
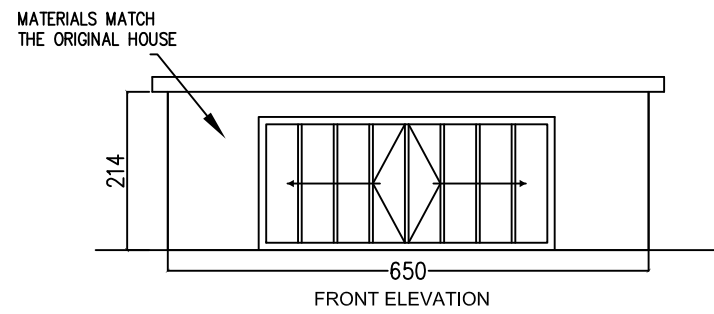
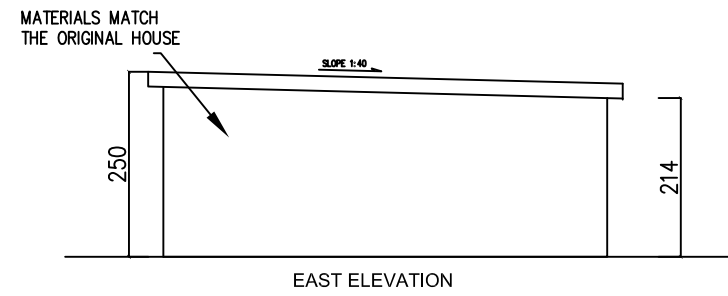
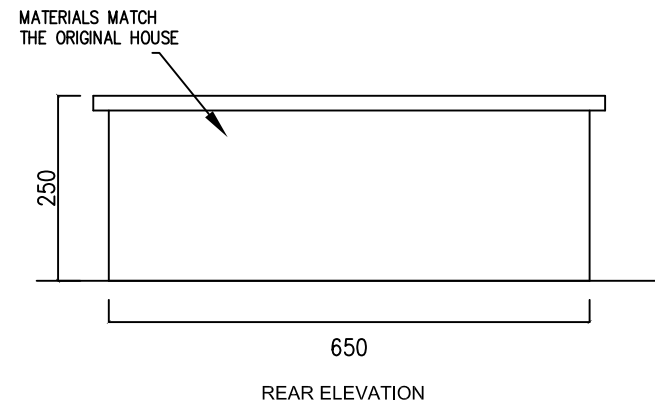
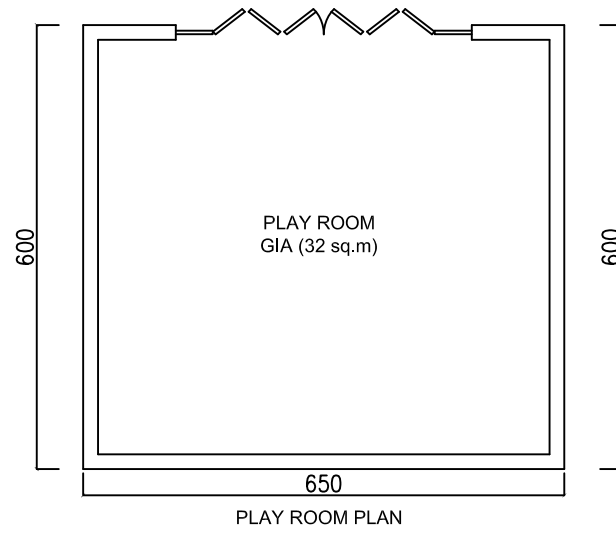

SITE:
263 Mays Ln, Barnet EN5 2LY

PROJECT NAME:
OUT BUILDING

DRAWING TITLE:
PROPOSED OUT BUILDING PLAN AND ELEVATIONS

DRAWING NO.:
LCENG-401-263-ENG2LY

STATUS:
PLANNING

DATE	26/04/2021	REV	0	DRAWN	AM
SCALE	1:100	SIZE	A3	SHEET	4 OF 5



336 Bellards Ln, North Finchley, London N12 0EY
T: 020 8123 1070
E: info@LCENG.co.uk
W: www.LCENG.co.uk

THIS DRAWING IS COPYRIGHT and must not be traced or reproduced in any way of form in part or whole by any means whatsoever without written consent from Lotus Engineers Ltd. This drawing may be copied by authorised officer of the Local Authority to assess the planning or building regulation application.

NOTES:

- DIMENSIONS ARE IN CENTIMETRE UNLESS NOTED OTHERWISE.



Original Garden Area
= 220 Sq.m

Total ground floor
extensions including the
outbuilding = 68 sq.m

AREA = 39 Sq.m

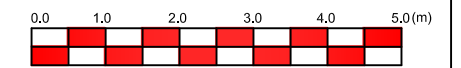

SITE:
263 Mays Ln, Barnet EN5 2LY

PROJECT NAME:
OUT BUILDING

DRAWING TITLE:
SITE PLAN

DRAWING NO.:
LCENG-401-263-ENG2LY

STATUS:
PLANNING

DATE	26/04/2021	REV	0	DRAWN	AM
SCALE	1:100	SIZE	A3	SHEET	5 OF 5



336 Ballards Ln, North Finchley, London N12 0EY
T: 020 8123 1070
E: info@LCENG.co.uk
W: www.LCENG.co.uk