





# White House

-  Sycamore to be retained
-  Hedgerow planting to be a mixture of wild flowers; Ferns, Bluebells and foxgloves. These will be spaced to allow for maximum coverage
-  Holly to be retained
-  Existing Hedgerow to be retained
-  Mixture of Hazel, Hawthorn, Blackthorn
-  Wildflower Meadow Seed

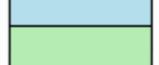
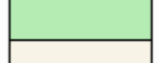

-  Proposed Hedgerow
-  Concrete block wall (cement render finish)
-  Proposed residential drive  
Oltco Recycle Bund
-  Paving Slabs
-  Grass
-  Gravel Drive

Trees to be retained

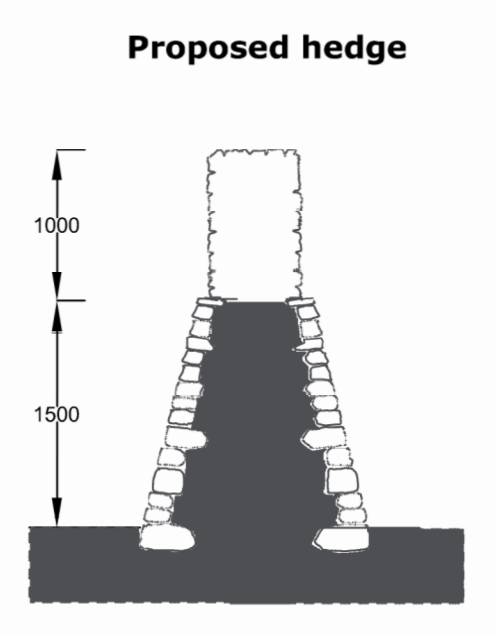

Scale 1:50



<b>Client:</b>	<b>ZEAT-KANE</b>
<b>Address</b>	<b>Land North of 6 Manor Rd TR16 5SD</b>
<b>Description</b>	<b>Site Layout including landscaping</b>
<b>Plan No.</b>	<b>ZKPS040920</b>
<b>Scale</b>	<b>1:100</b>



Scale 1:200