

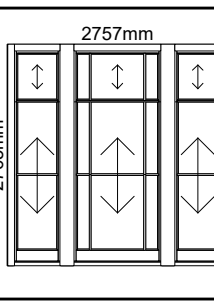

Client **130 Dyke Road**

Job

	<p>Sliding Sash</p> <p>Bay Window Standard Box Sliding sash - ovolo mould to sashes, weights, cords, No horns to top sash.</p> <p>47 mm Sashes - 12mm Slim D/G Units - Utile Outer Lining - Utile Pulley stiles, head & internal lining Timber Type: Utile</p> <p>Decoration spec: Preservative treatment - 2 x Teknos Primer/Undercoat - 1 x Teknos Top Coat White</p>	<p>W1,W2,W3</p> <p>×1</p>
	<p>Sliding Sash</p> <p>Rear Single Window Standard Box Sliding sash - ovolo mould to sashes, weights, cords, No horns to top sash.</p> <p>47 mm Sashes - 12mm Slim D/G Units - Utile Outer Lining - Utile Pulley stiles, head & internal lining Timber Type: Utile</p> <p>Decoration spec: Preservative treatment - 2 x Teknos Primer/Undercoat - 1 x Teknos Top Coat White</p>	<p>W4</p> <p>×1</p>
	<p>Casement</p> <p>Kitchen Sash Only Sidelight 45mm Thick 12mm Slim DGU Timber Type: Utile</p>	<p>W5</p> <p>×1</p>
	<p>Casement</p> <p>Obscure Small Sash Sidelight 45mm Thick 12mm Slim DGU Timber Type: Utile</p>	<p>W6</p> <p>×1</p>

Client **130 Dyke Road**

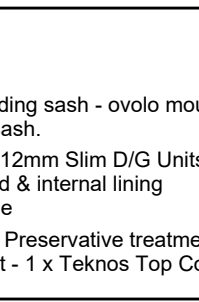
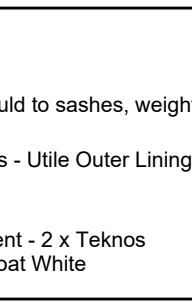
Job

1 X Sliding Sash - W1,W2,W3 (Bay)

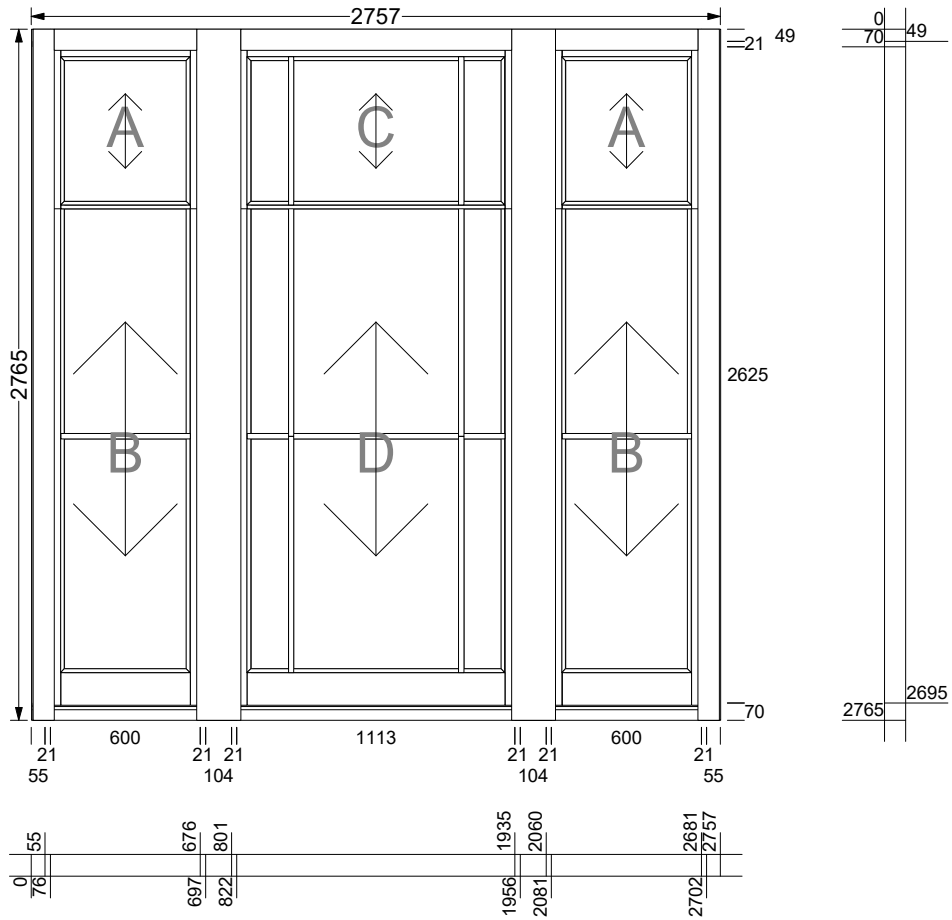

W1,W2,W3
Top sliding sash x 2

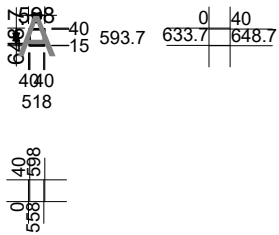

W1,W2,W3
Top sliding sash

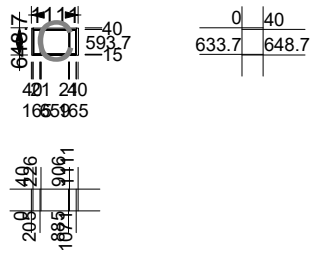

W1,W2,W3
Bottom sliding sash x 2

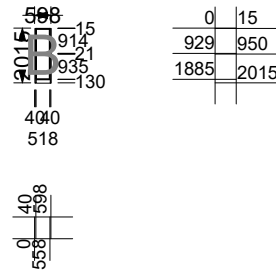

W1,W2,W3
Bottom sliding sash

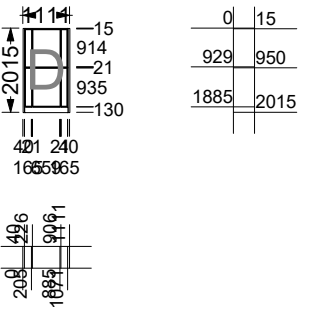

1 X Sliding Sash - W4 (Rear)

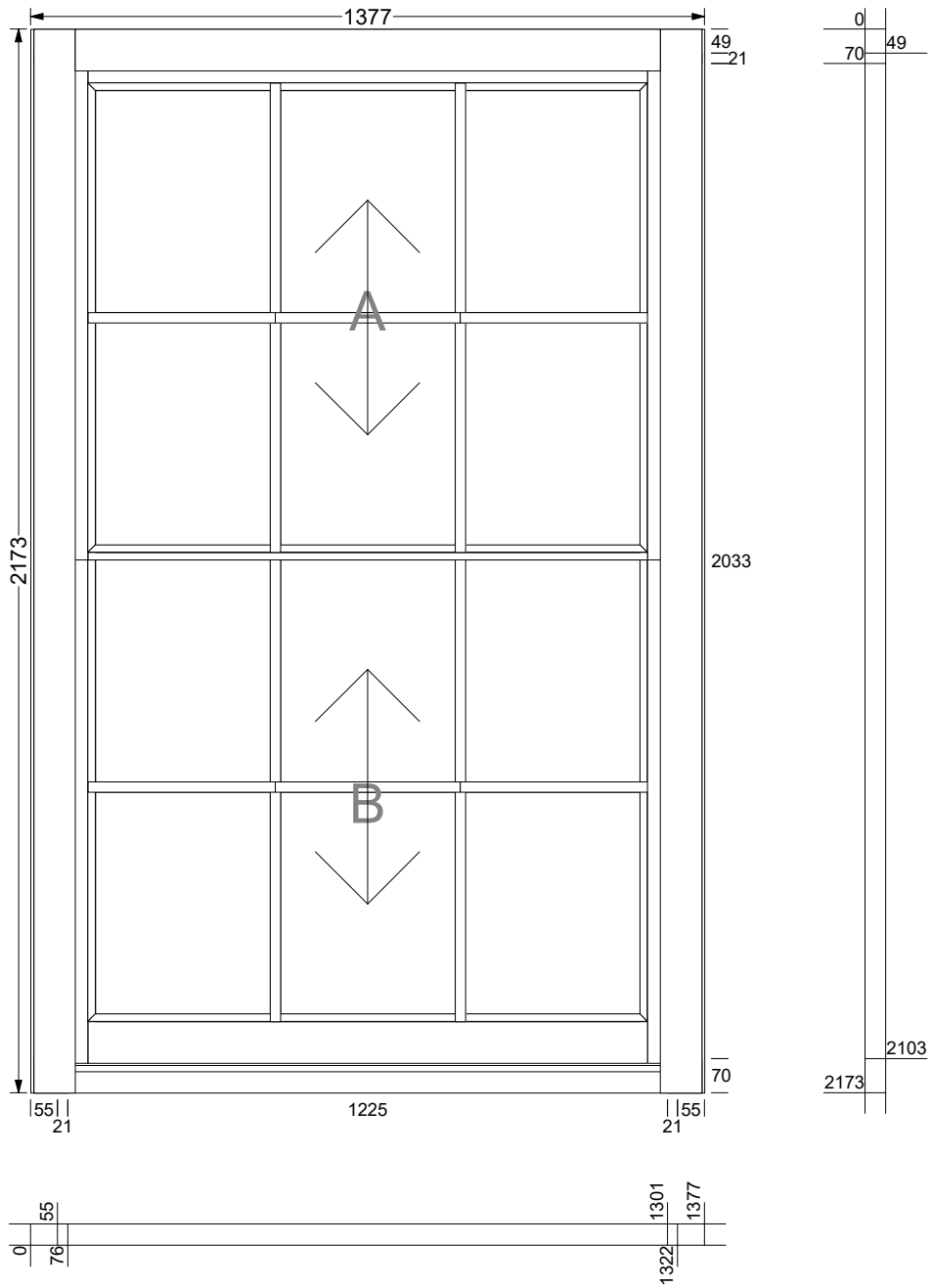

Mid size Diagrams with setting out

**W4
Top sliding sash**

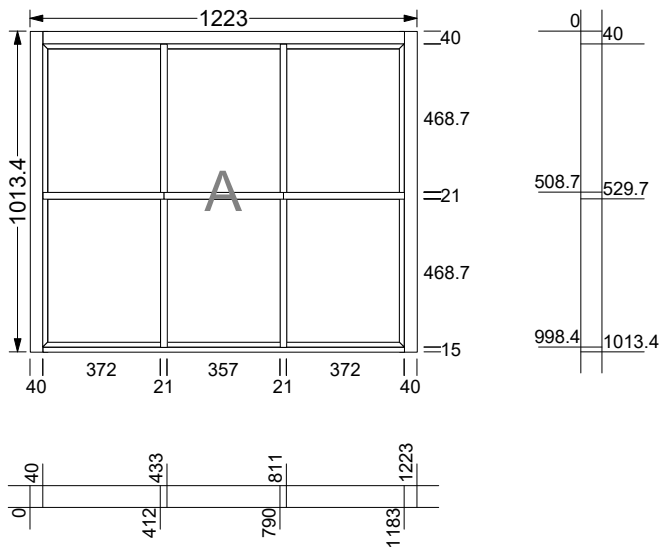

**W4
Bottom sliding sash**

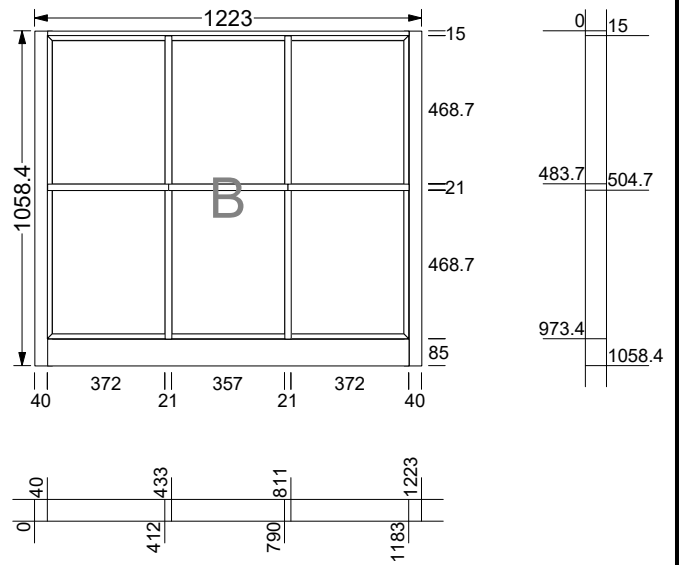

1 X Casement - W5 (Kitchen)

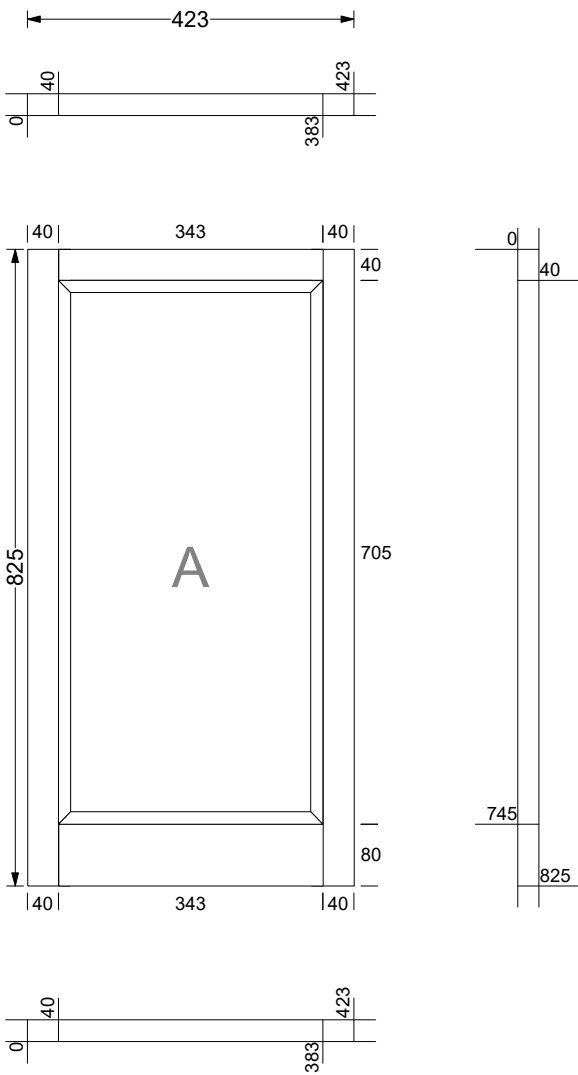

**W5
Screen Casement Fixed**

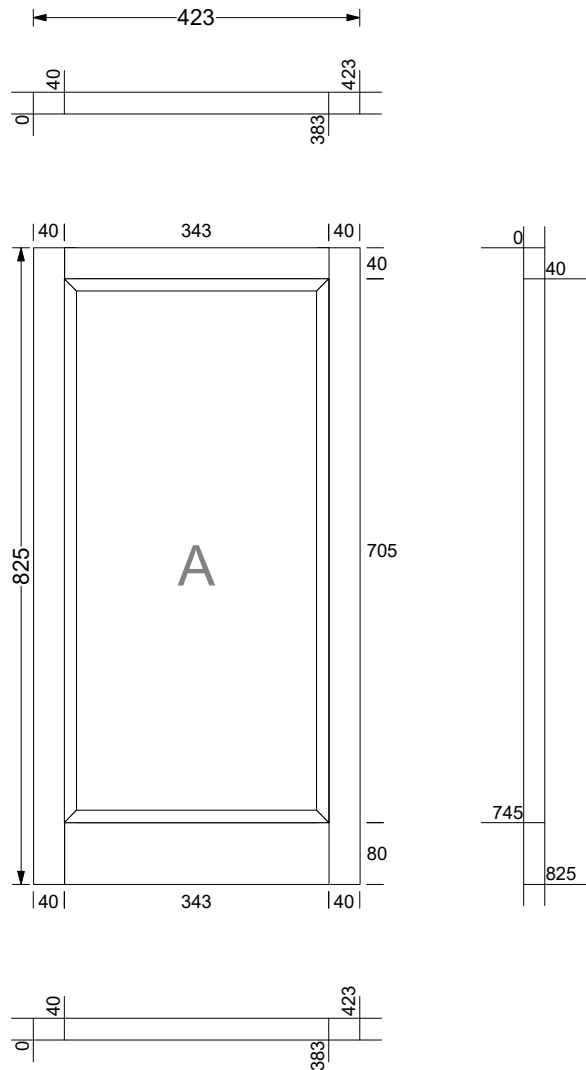

Mid size Diagrams with setting out

1 X Casement - W6 (Obscure)

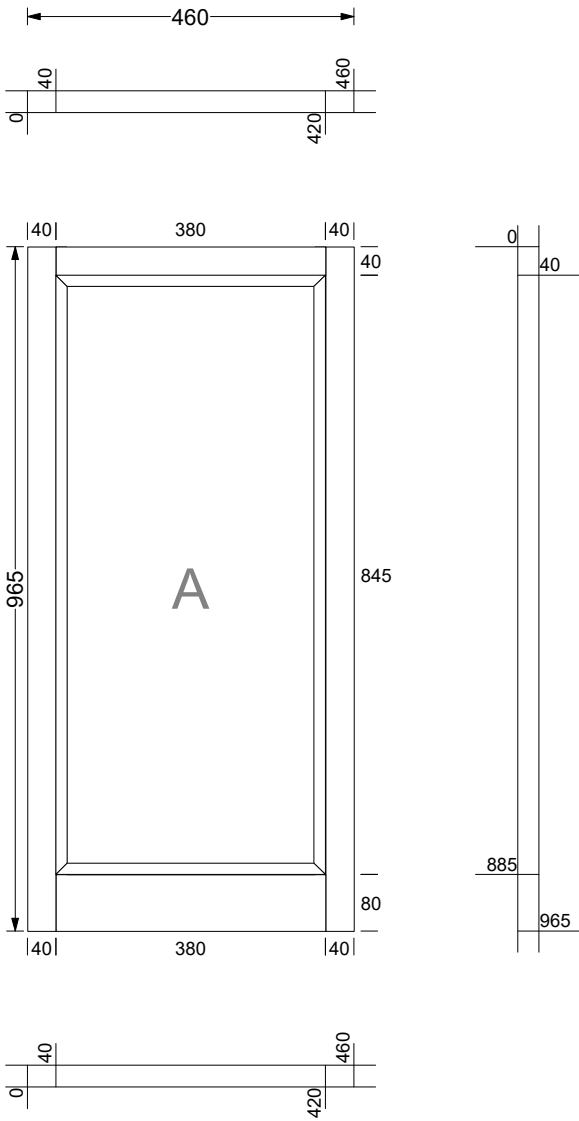

**W6
Screen Casement Fixed**

