

GROUND FLOOR PLAN

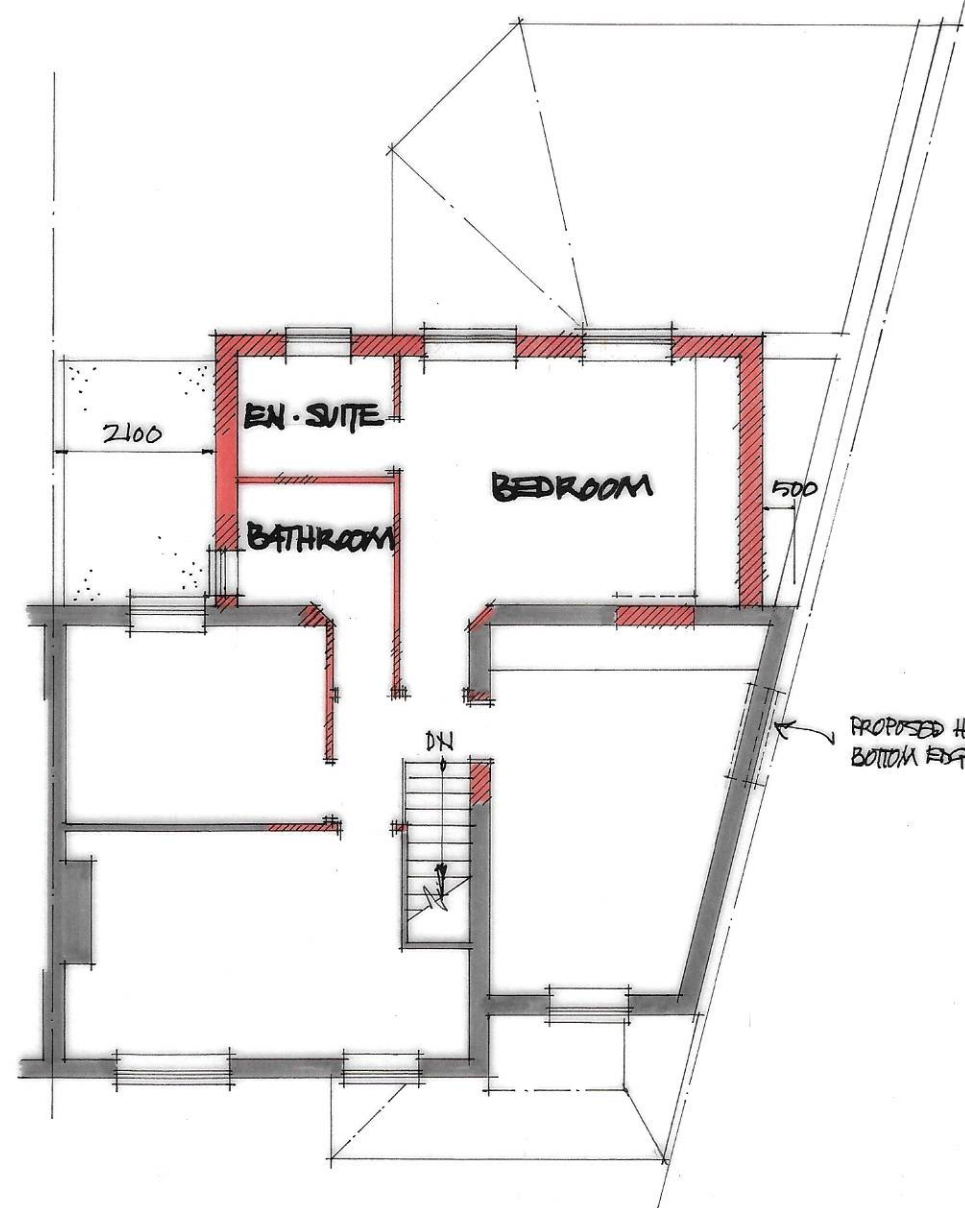

FIRST FLOOR PLAN

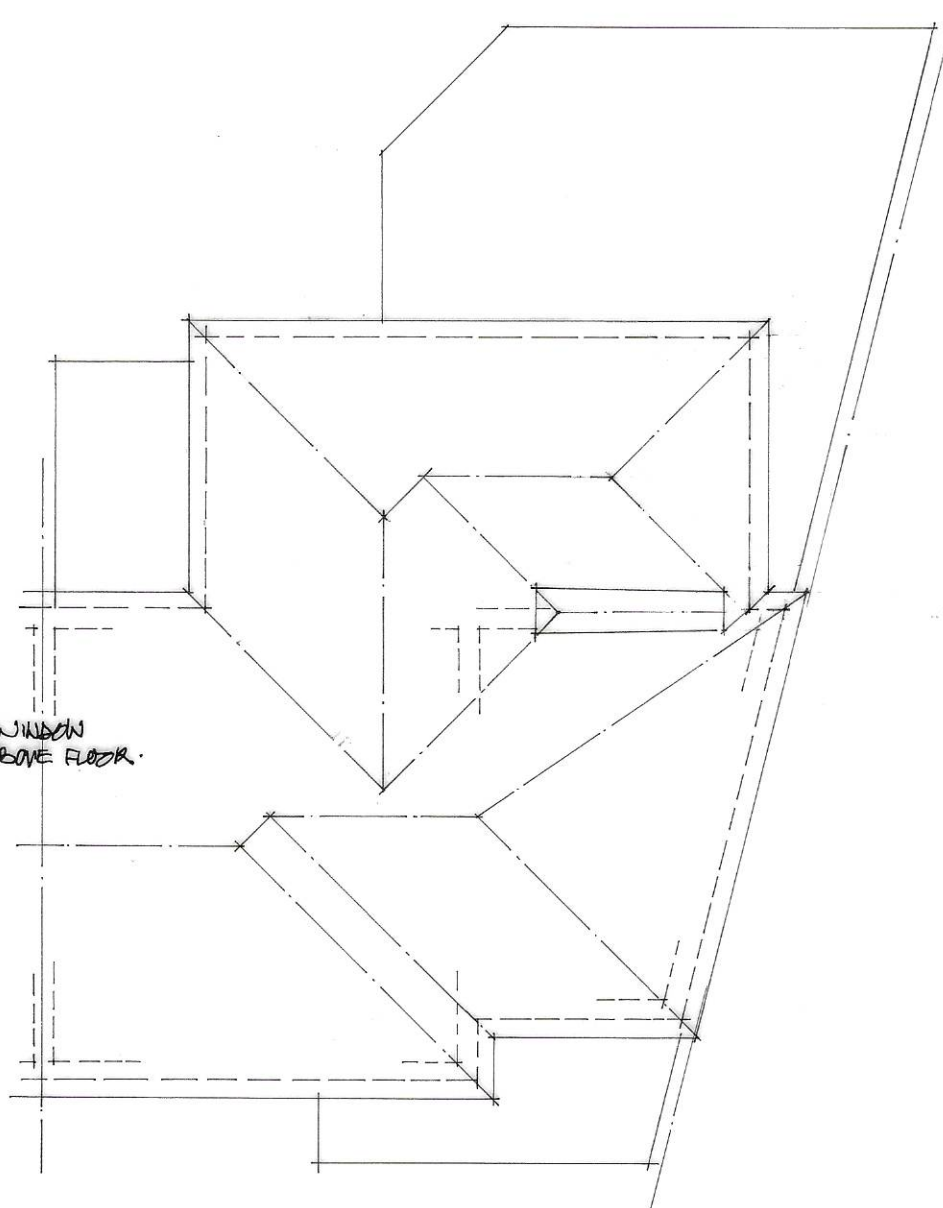

ROOF PLAN

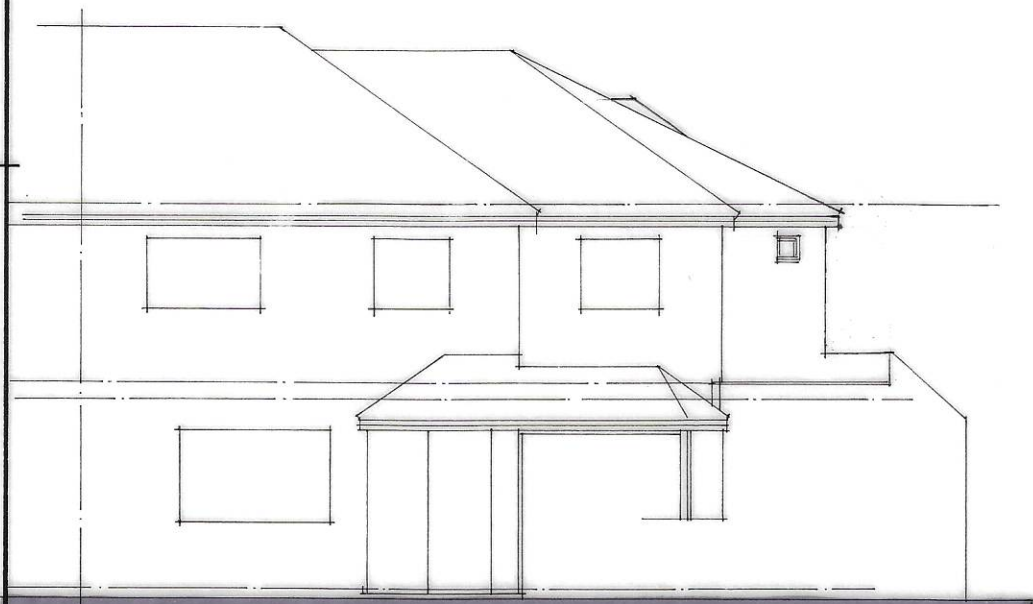
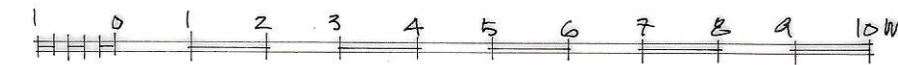
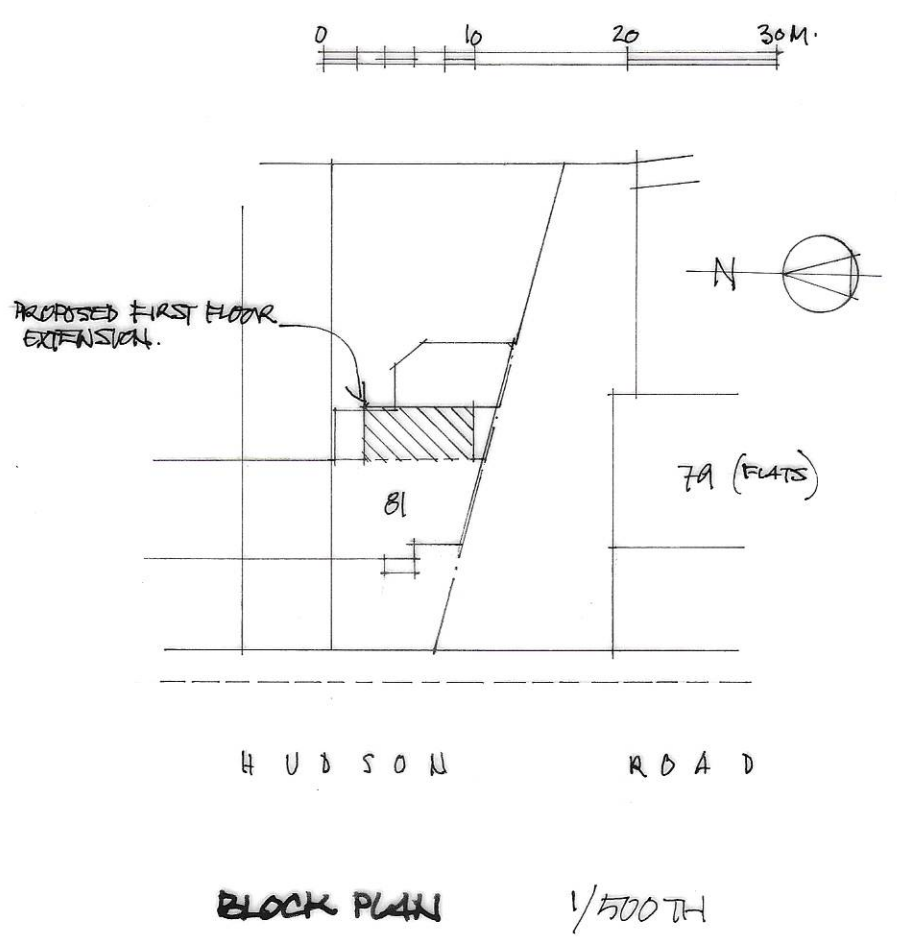

ELEVATIONS - FRONT

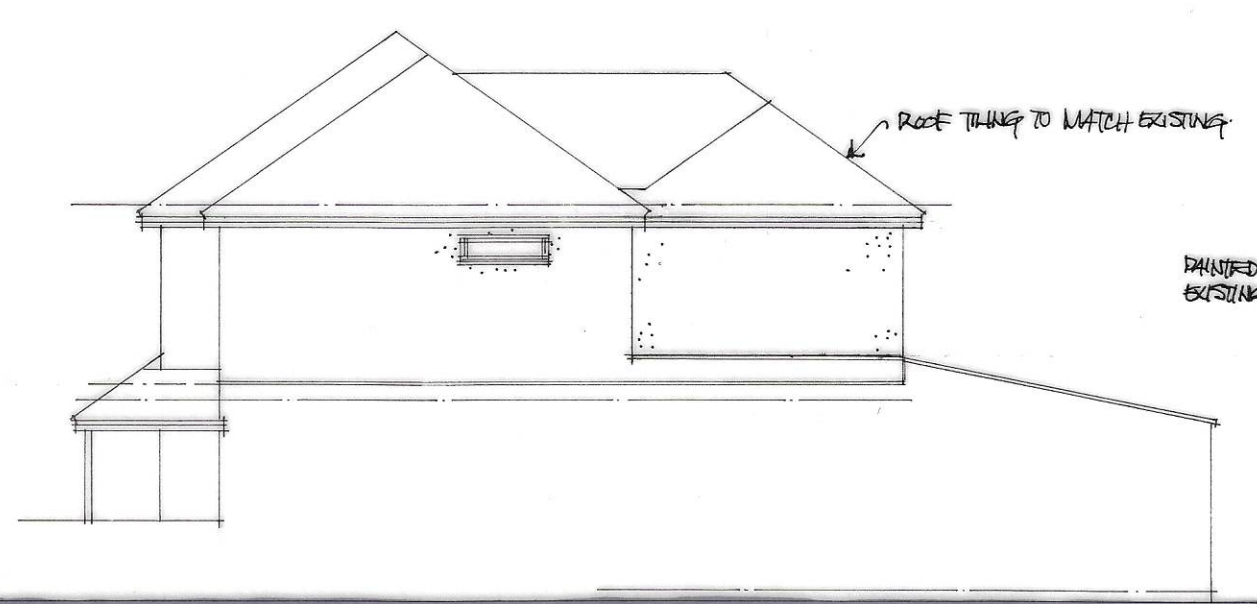

SIDE

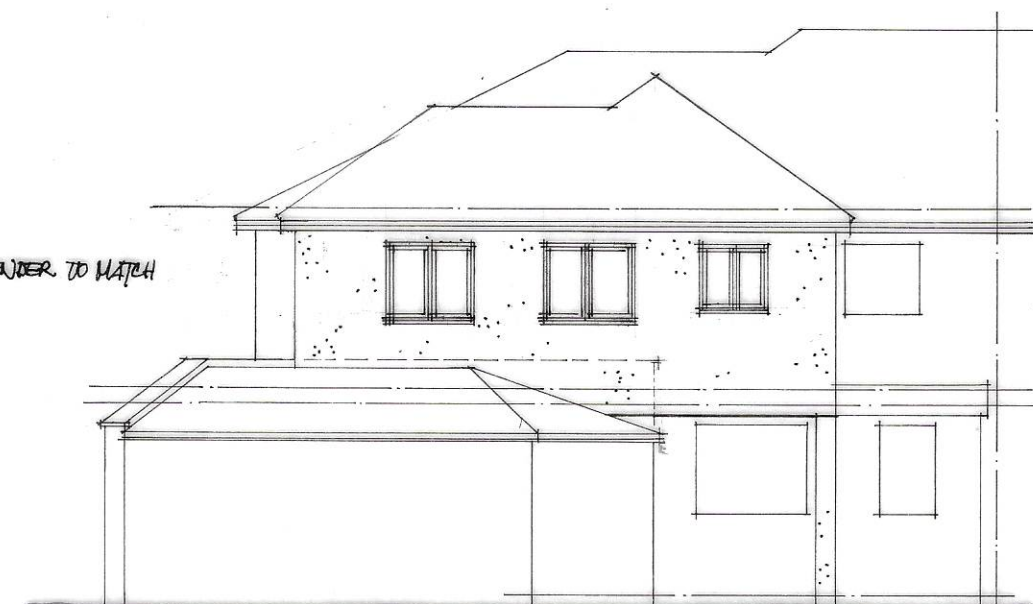

REAR

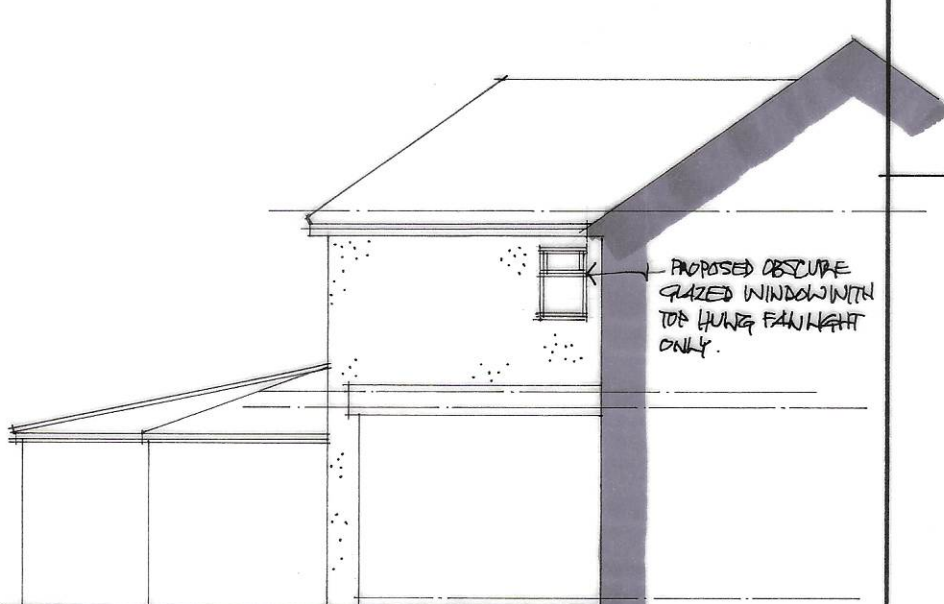

REAR FLANK

PROPOSED ALTERATIONS & EXTENSION TO REAR OF
 B1 HUDSON ROAD · BECKLEYHEATH · KENT · DA7 4PG

FLOOR PLANS & ELEVATIONS AS PROPOSED

Scale 1/500 TH A2 SIZE Date OCTOBER 2021

Drawing No. 70943/2

I. K. Wyatt Building Design Ltd.
 11 Woodlands Road, Orpington, Kent, BR6 6EB Tel: (01689) 859236

'A' REV. 4 NOV 21 EXT FLANK WALL MOVED OFF EXISTING AND FLOOR WALL & MADE SQUARE TO REAR WALL.

B1 HUDSON RD.