

GROUND FLOOR PLAN

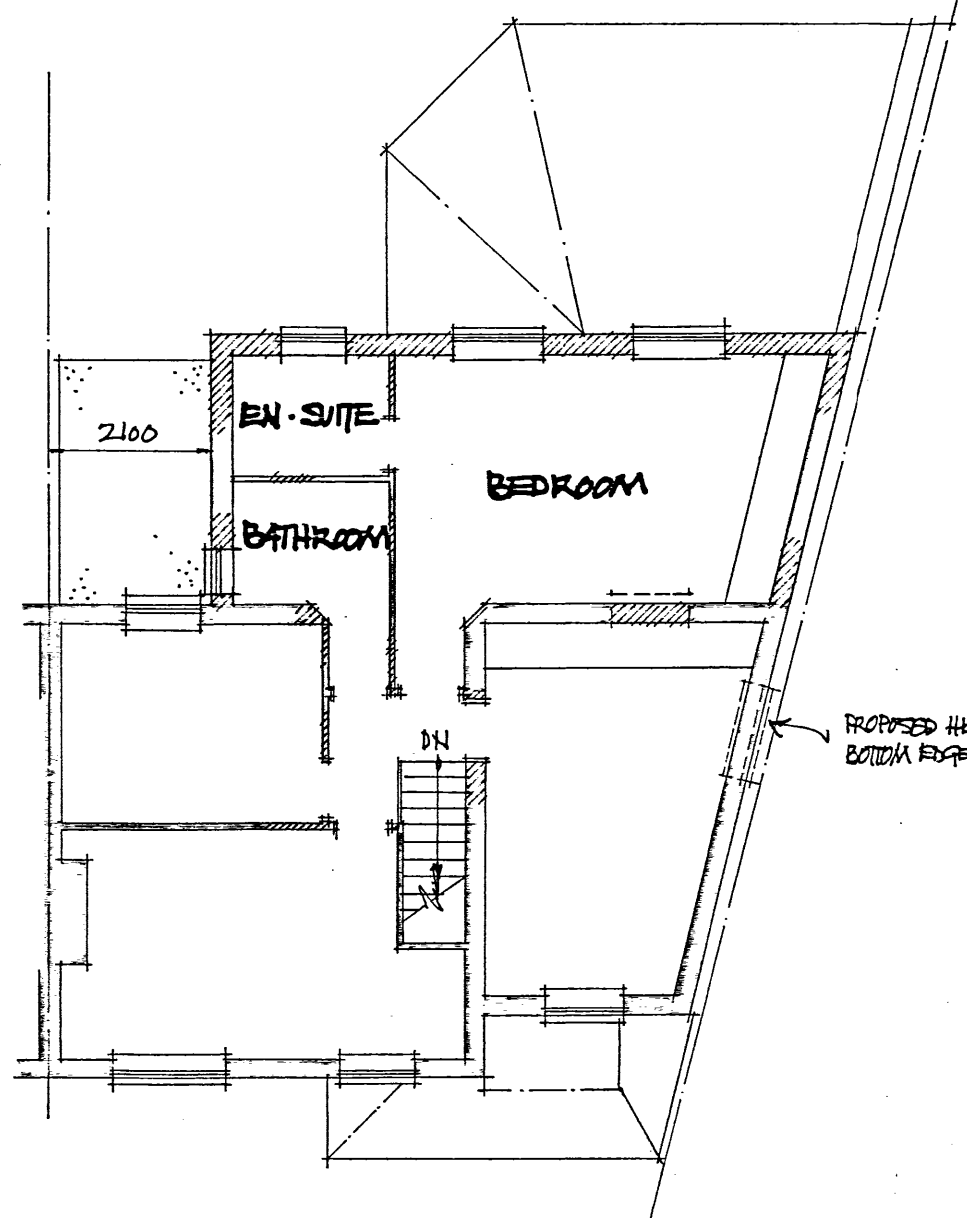

FIRST FLOOR PLAN

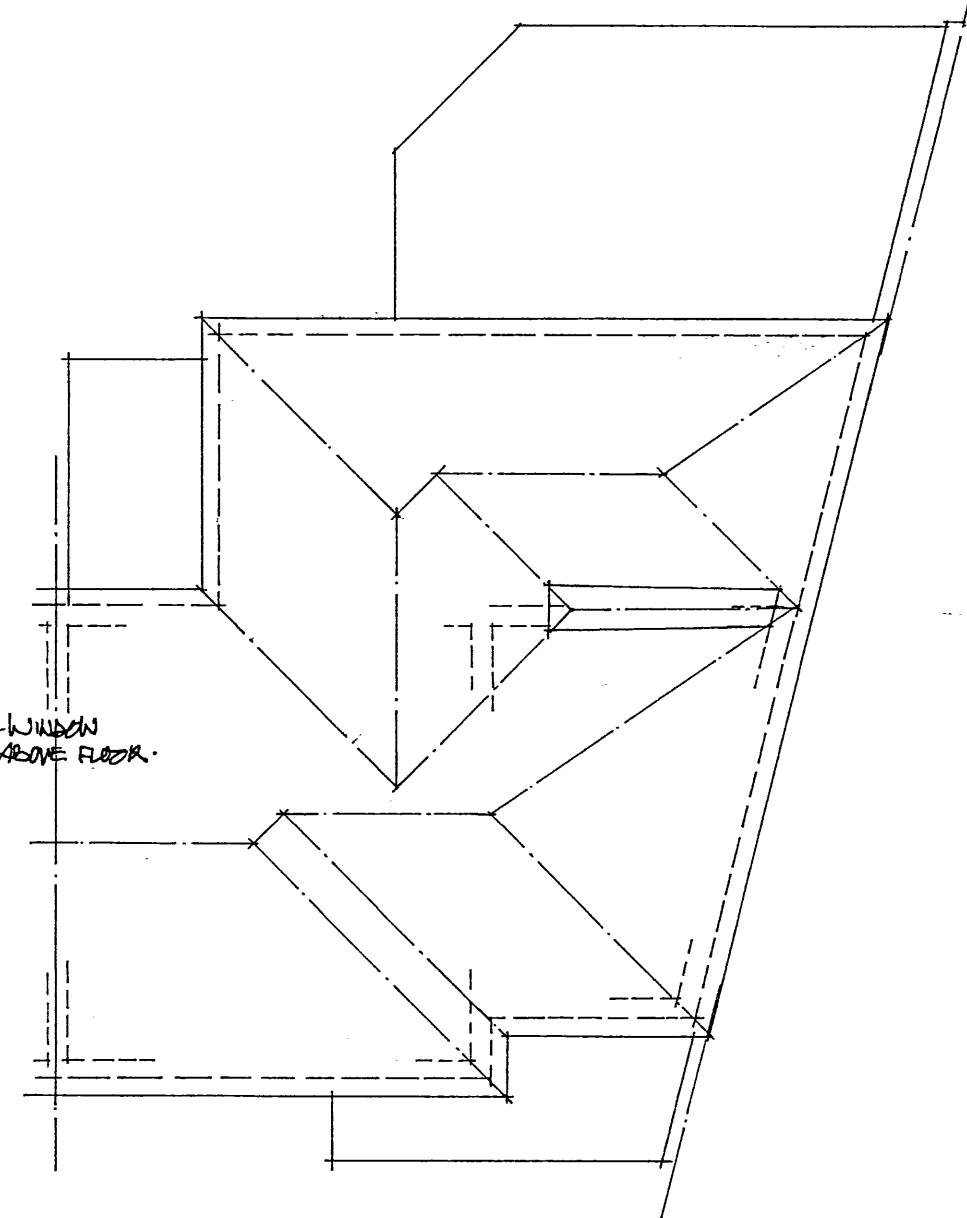

ROOF PLAN

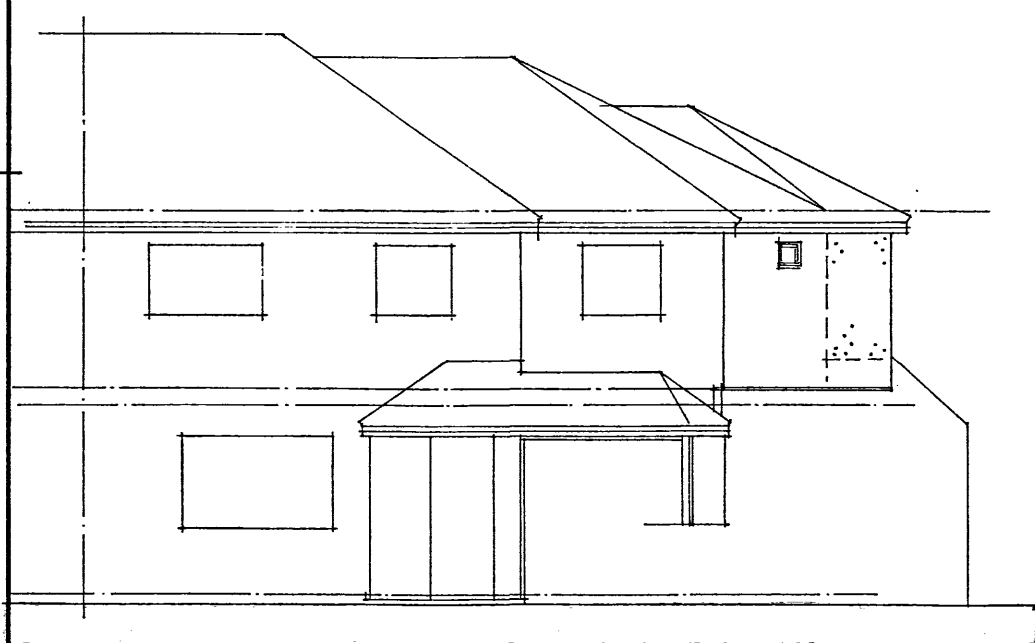
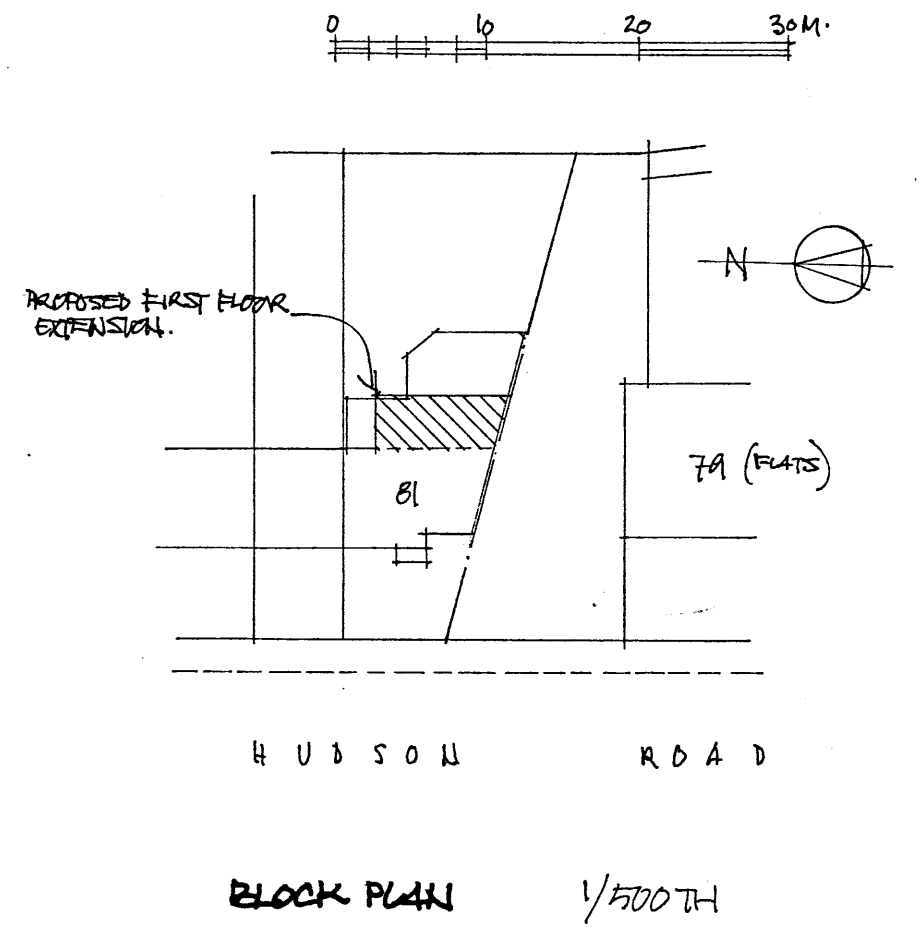

ELEVATIONS - FRONT

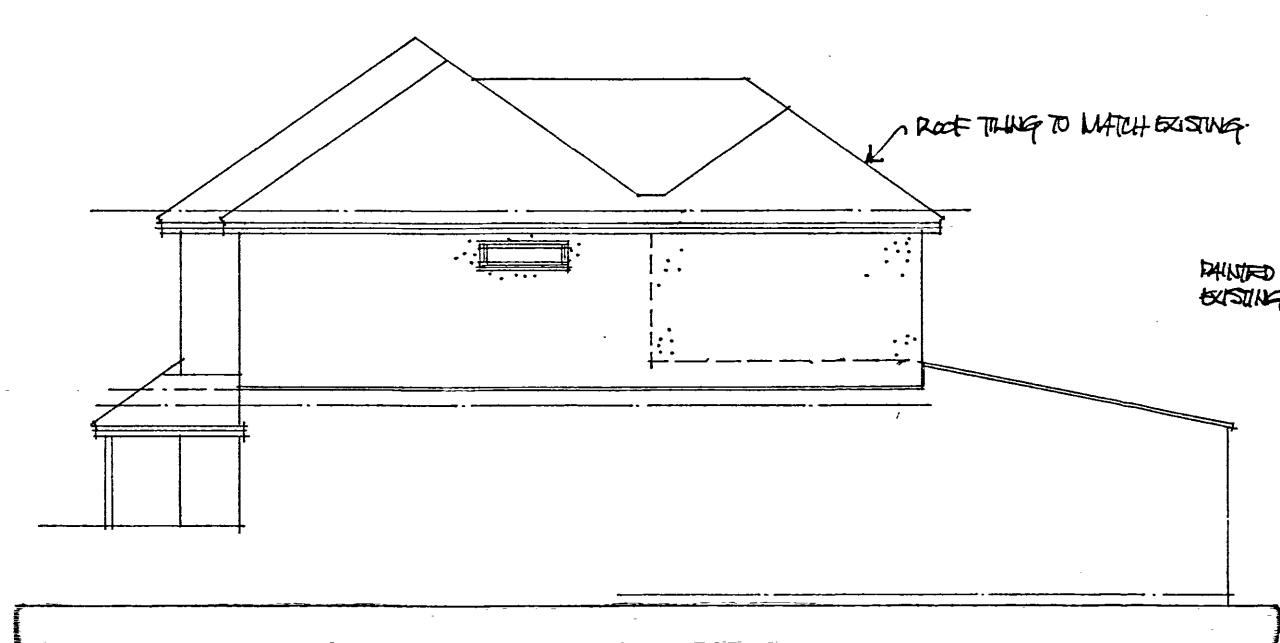

SIDE

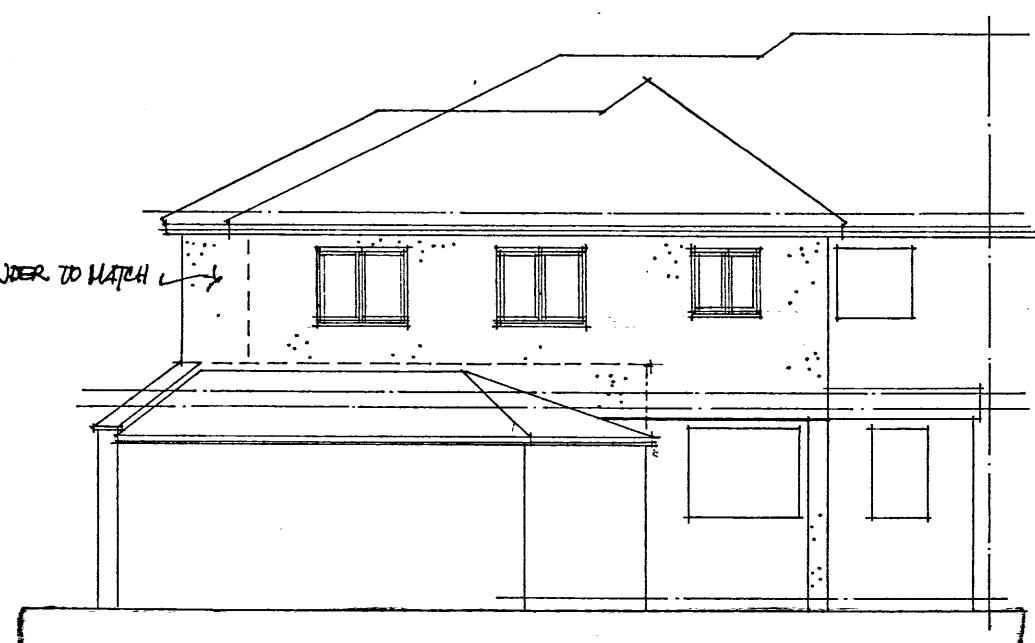

REAR

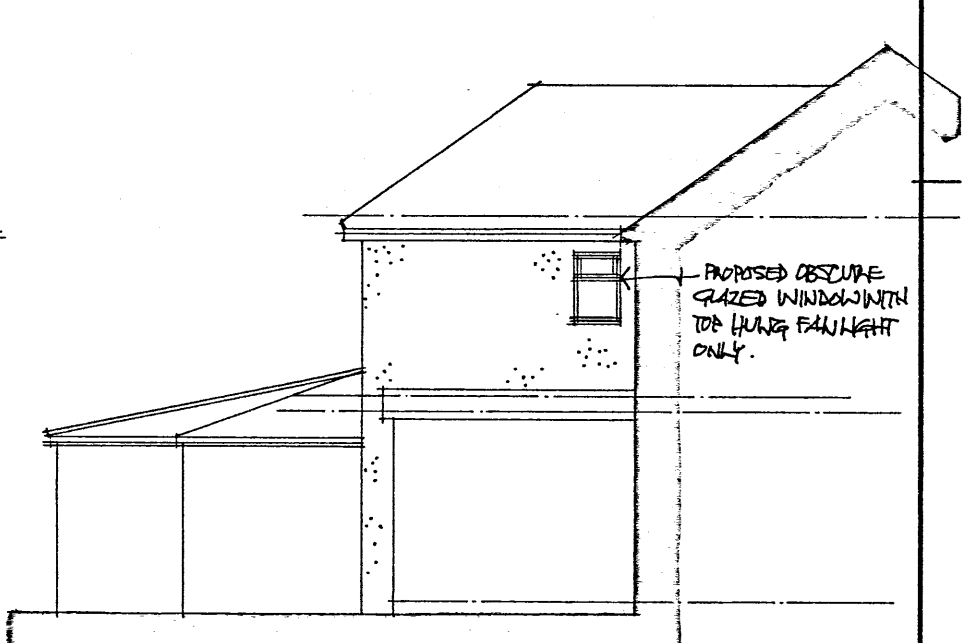

REAR FLANK

PROPOSED ALTERATIONS & EXTENSION TO REAR OF
 81 HUDSON ROAD · BEKLEYHEATH · KENT · DA7 4PG

FLOOR PLANS & ELEVATIONS AS PROPOSED

Scale 1/100TH AT A2 SIZE Date OCTOBER 2021

Drawing No. 70943/2 21/03197/fjl

I. K. Wyatt Building Design Ltd.
 11 Woodlands Road, Orpington, Kent, BR6 6EB Tel: (01689) 859236