

# Shed Elevations

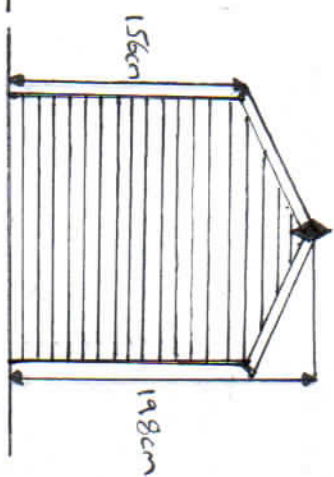

# Pergola Elevations

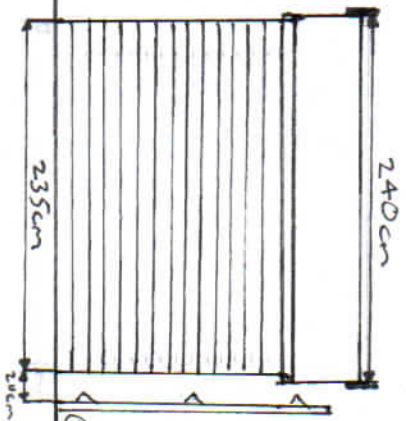

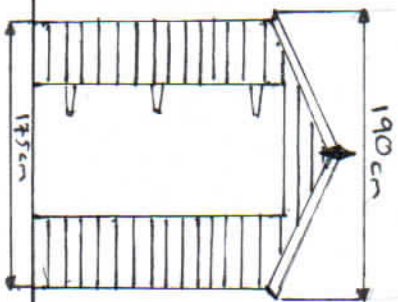
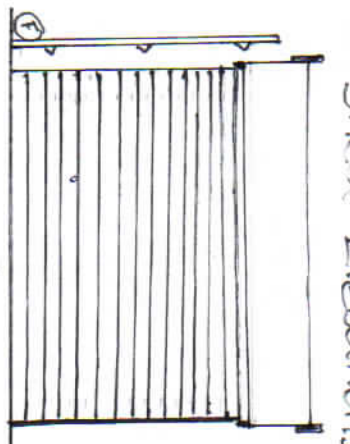
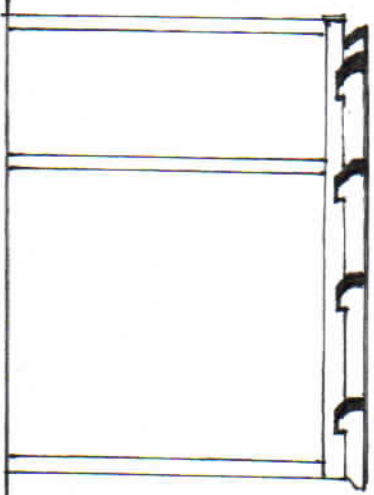
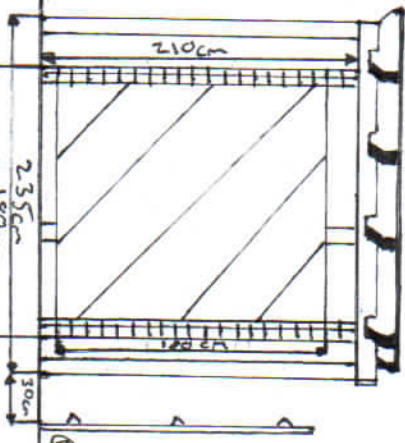
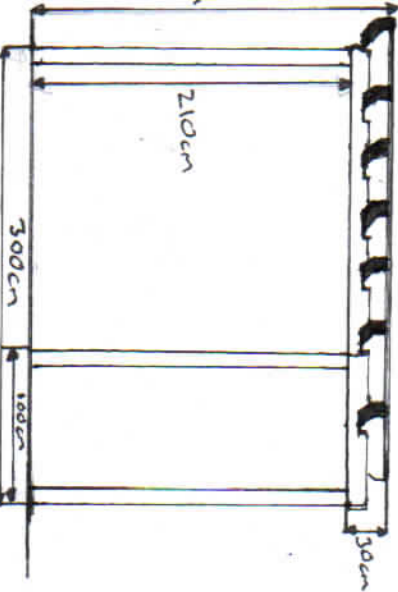
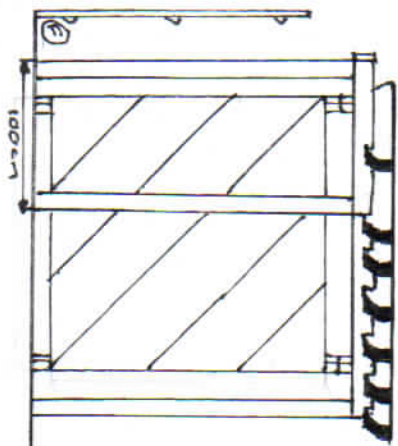

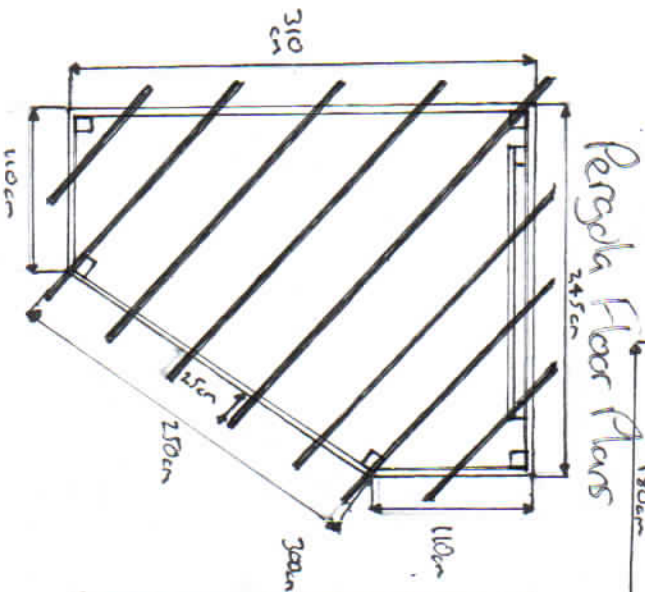
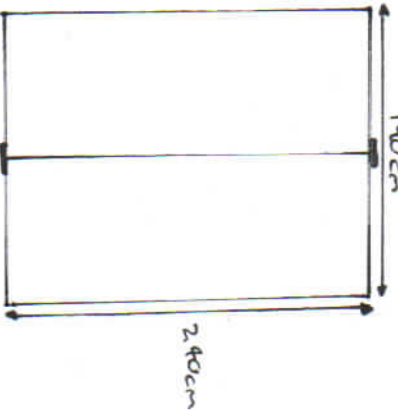
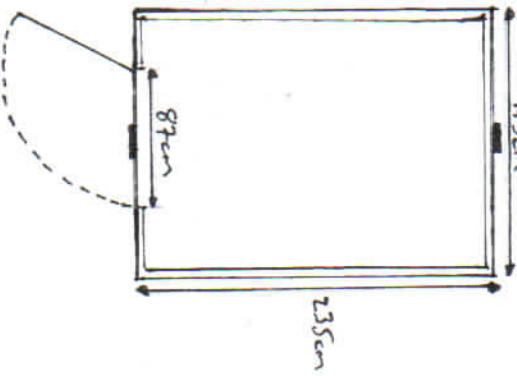
# Shed Floor Plans

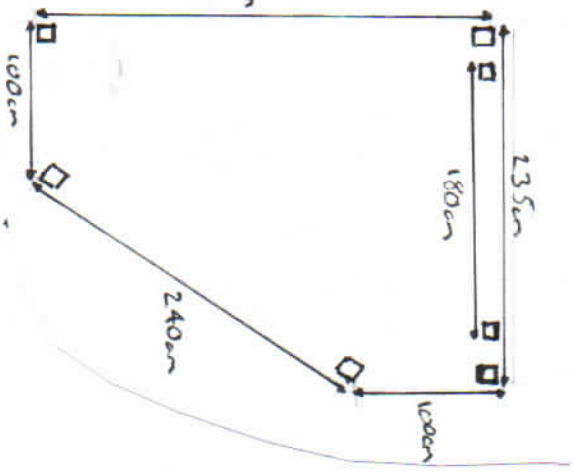

# Pergola Floor Plans



-  Trellis
-  Pergola Post
-  Earth Fence

Scale = 1:50