

Technical Drawing

Please check all dimensions and material spec on this drawing before placing an order.

All sizes shown below are in plan view (measured horizontally).
 #1 is the first tread at the bottom.
 Stair width is over strings NOT including newel posts.
 All sizes are to be checked on site.

Construction Detail	Job Ref: Q280279
	Customer Date: 4/2/2021 Site/Plot: Phone:

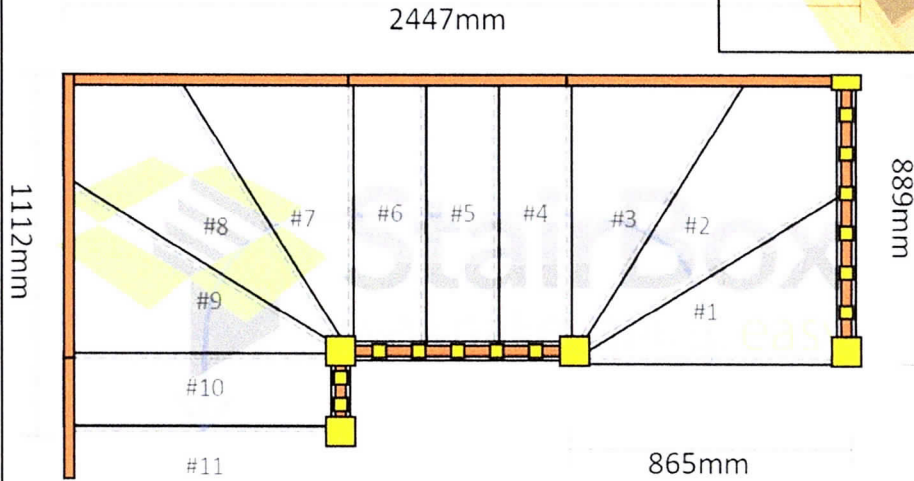

OS Quote

Assembly and Packaging

This Staircase is Assembled (Main Runs Only)

Technical Details

Total Rise	2210mm
Individual Rise	11 @ 200 91mm
Individual Going	223 13mm
Staircase Pitch	42 00 degrees
Width Over Strings(mm)	865mm

Specification

Strings	32mm Engineered Oak
Treads	22mm Oak (9mm Veneered Risers)
Newels	90x90mm Engineered Oak (Square)
Spindles	41x41mm Engineered Oak (Square)
Handrail	58x56mm Engineered Oak (Cheshire patt)
Baserail	63x32mm Engineered Oak (Cheshire patt)
F. Tread	n/a

Weight: 208.43 (2.5pts)

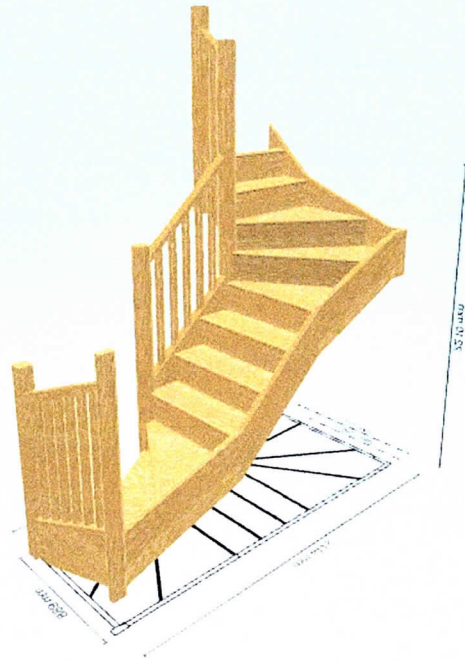

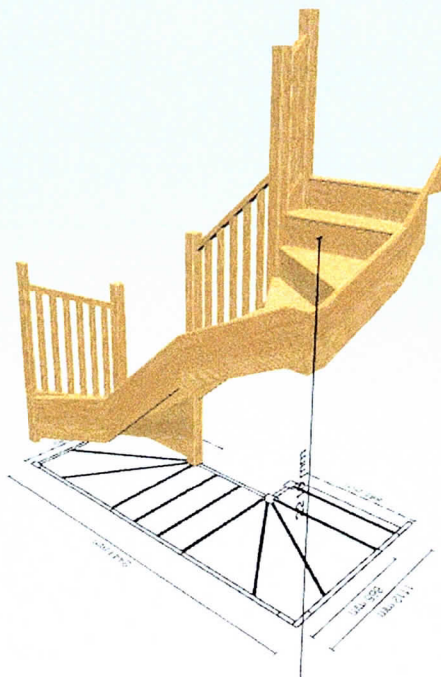

Included as standard with your staircase:

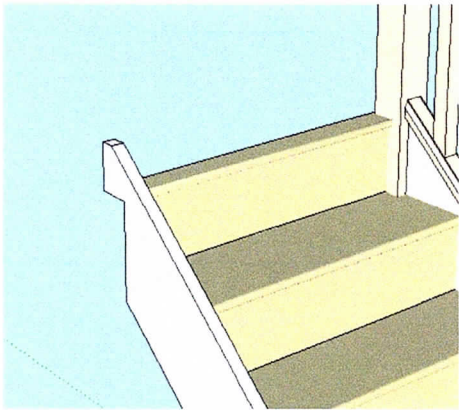

Head and foot cuts prepared

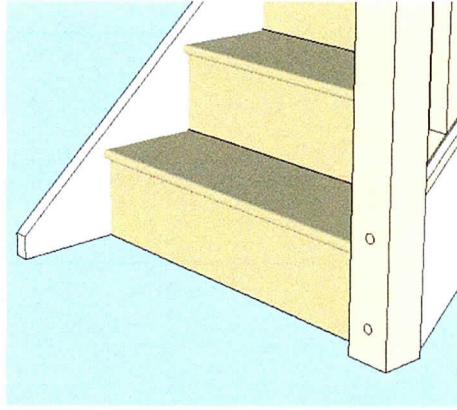

Included as standard with your raking balustrade:

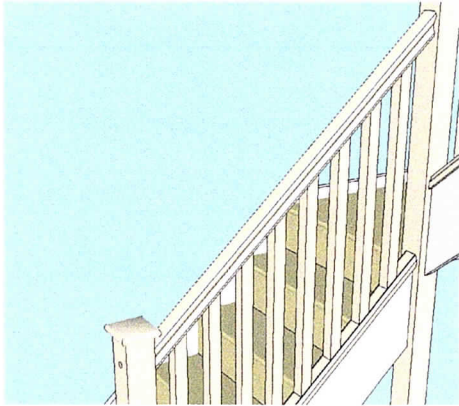

Raking handrails pre-cut

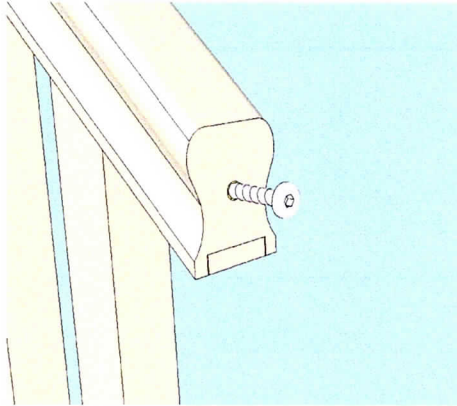

Raking handrail mechanical fixings

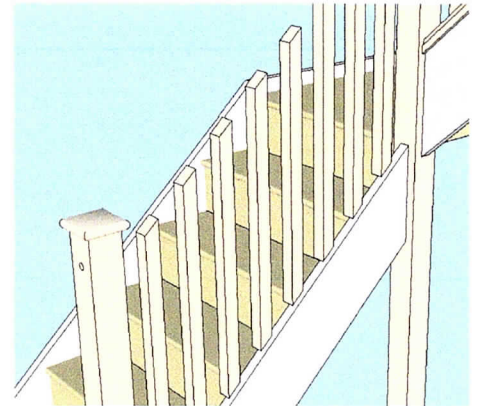

Raking spindles pre-cut

Included as standard with your landing balustrade:

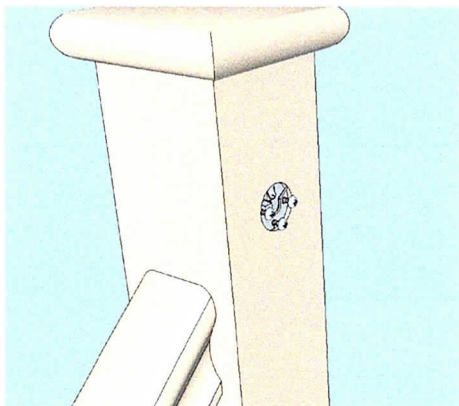

RailFix landing handrail fixings

Included as standard on 1/4 landing staircases:

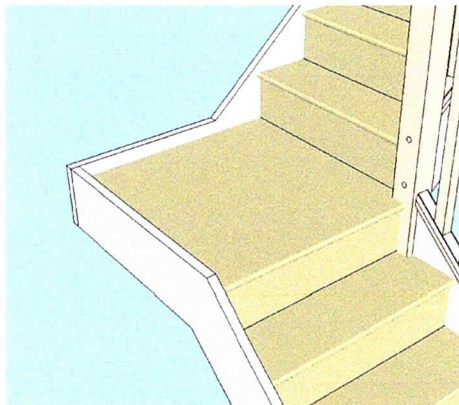

Pre-fabricated 1/4 landings*

*Joist supports are not supplied, 1/4 landings *must* be adequately supported on the underside when fitting.

*Half landings are NOT pre-fabricated, floor boards, stringers and joists NOT supplied by StairBox.