

SPECIFICATION

Kitchen roof covered in Marley Wessex Roof Tile on 30x25mm slater laths slaters felt on rafters continuous ridge vent 25mm continuous vermin proof vents 30x5mm galvanized restraint straps to wallplate and end rafters to Gable at 2mcc 100x50mm sw wallplate. 100mm pvc gutter 65mm downcomers. lead flashings and soakers. cavity tray to exposed existing wall abutting new extension code 4 lead 112mm wire cut red rustic bricks. 100mm dritherm, 100mm thermalite blocks lightweight plaster internally, stainless steel wall ties at 450mm vertical & 750mm horizontal cc. & every course around door & window reveals all to DDI40 level in outer leaf. Inner dpc lapped on to visqueen Cavity fill up to 225mm below lowest dpc. Insulated closers to all reveals. Dpc to all vertical & horizontal reveals. 150mm above finished externally. Ventilation opening lights equivalent to 1/20th of room floor area Mechanical ventilation to kitchen 60l per second Maintain any sub floor ventilation. If required, provide new airbrick to external extension wall and plastic ducting through floor to existing airbrick in existing wall. internal partition 12.5mm plaster-board and skim on 100x50mm sw stud access to be maintained for refuse collection. Glazing to comply with Part N of the Building Regulations 2010 All new glazing is to be Pilkington K, argon filled Type double glazed 28mm cavity 8000mm² trickle vents to windows 3 in 4 lights to be energy efficient. TRV valves to all new radiators. No Trees within 20m

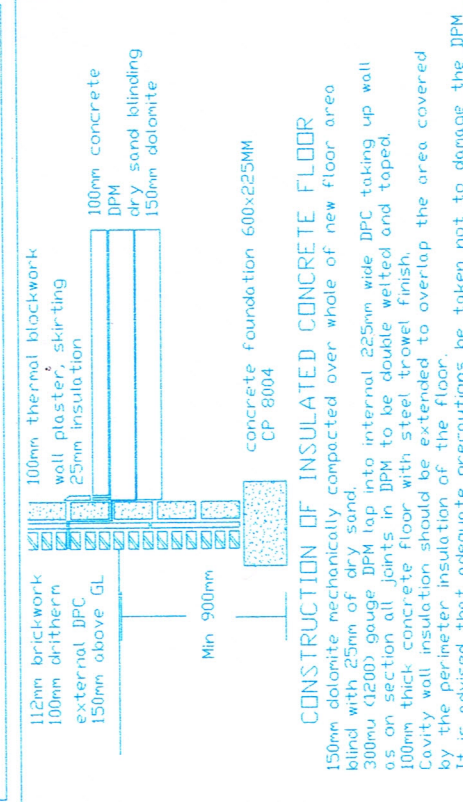

24 Salisbury Close, Great Lumley, Co Durham, DH3 4LQ. Single Storey Rear Extension. Drawing No. S66b Scale 1:100. Date 25/03/2022. Mr AM Watt 20 Alpine Way Sunderland SR3 1TN Tel No. 0191 5226401 078116 050 33

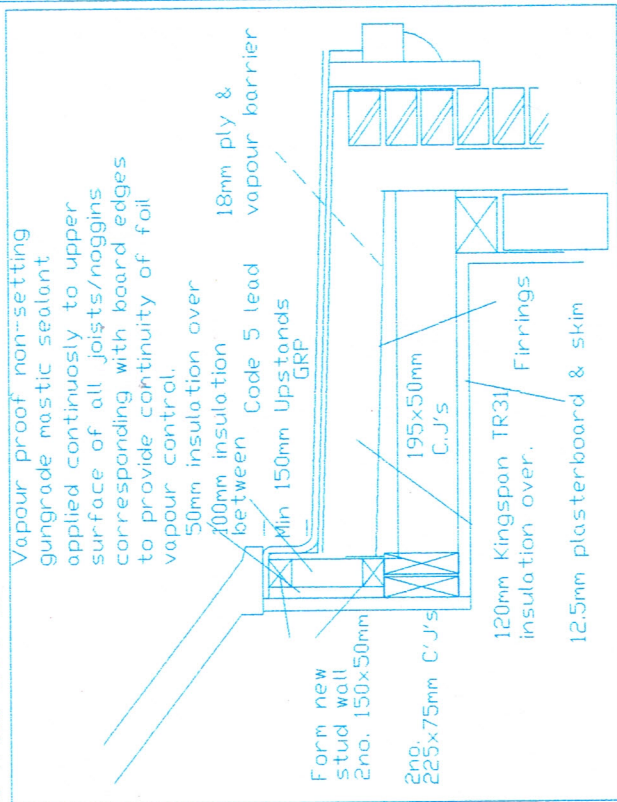
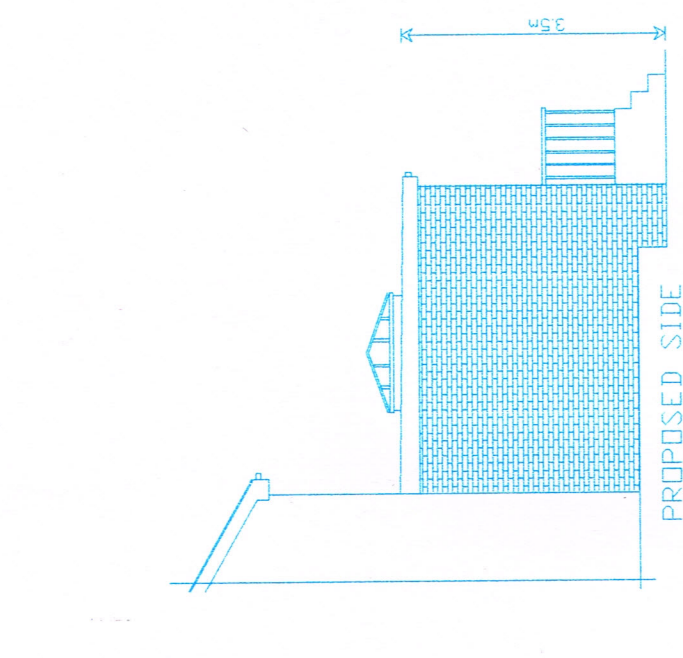
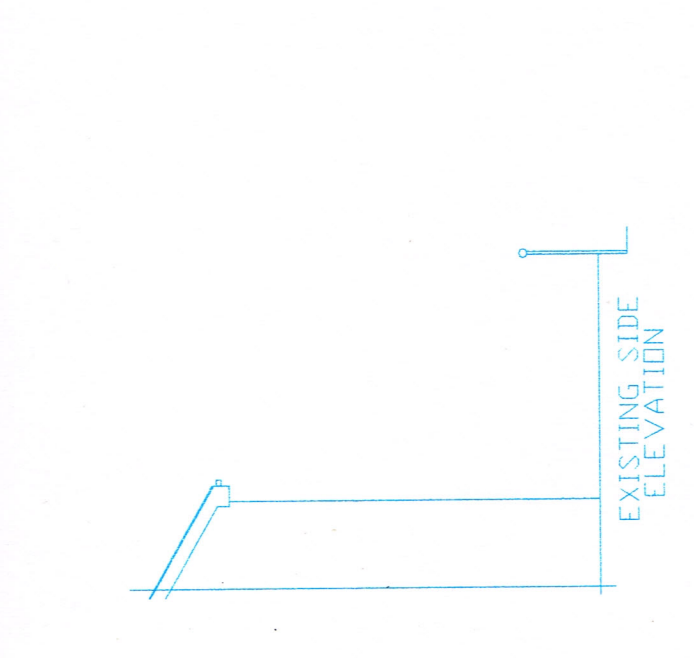
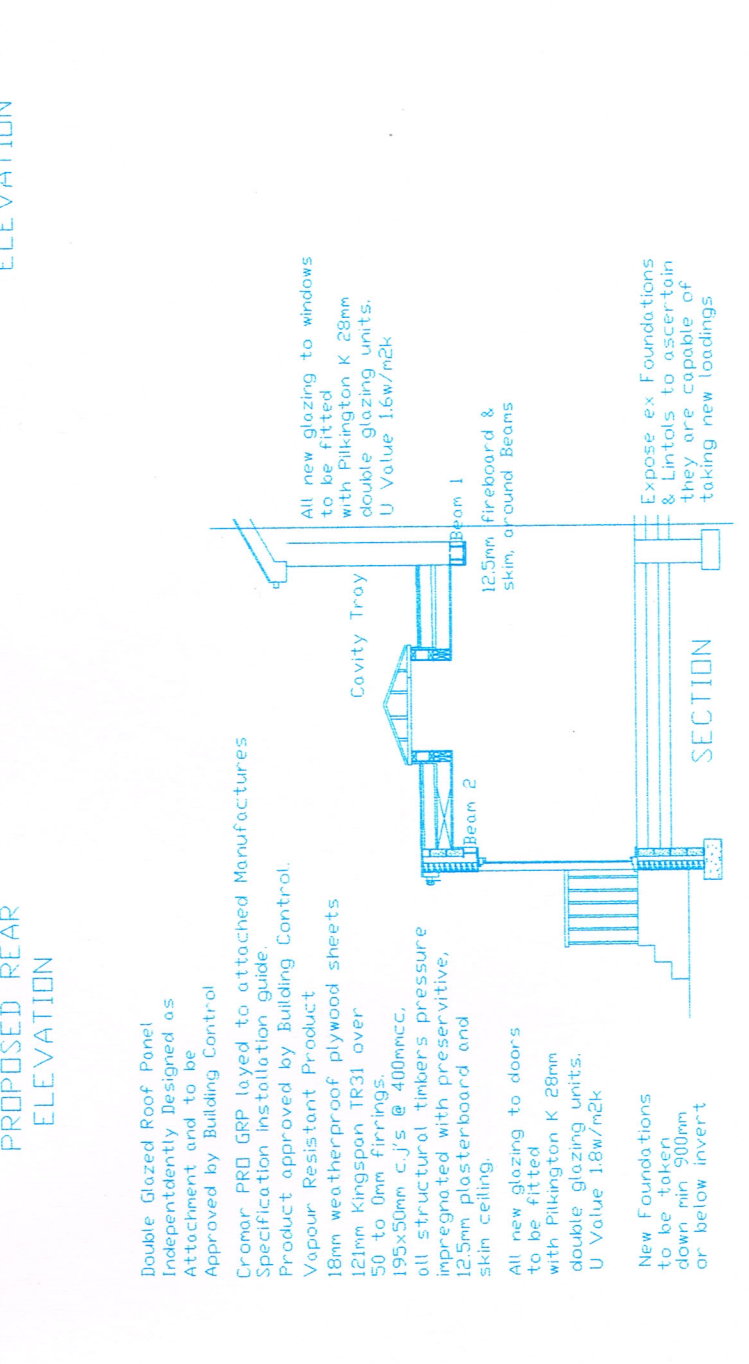
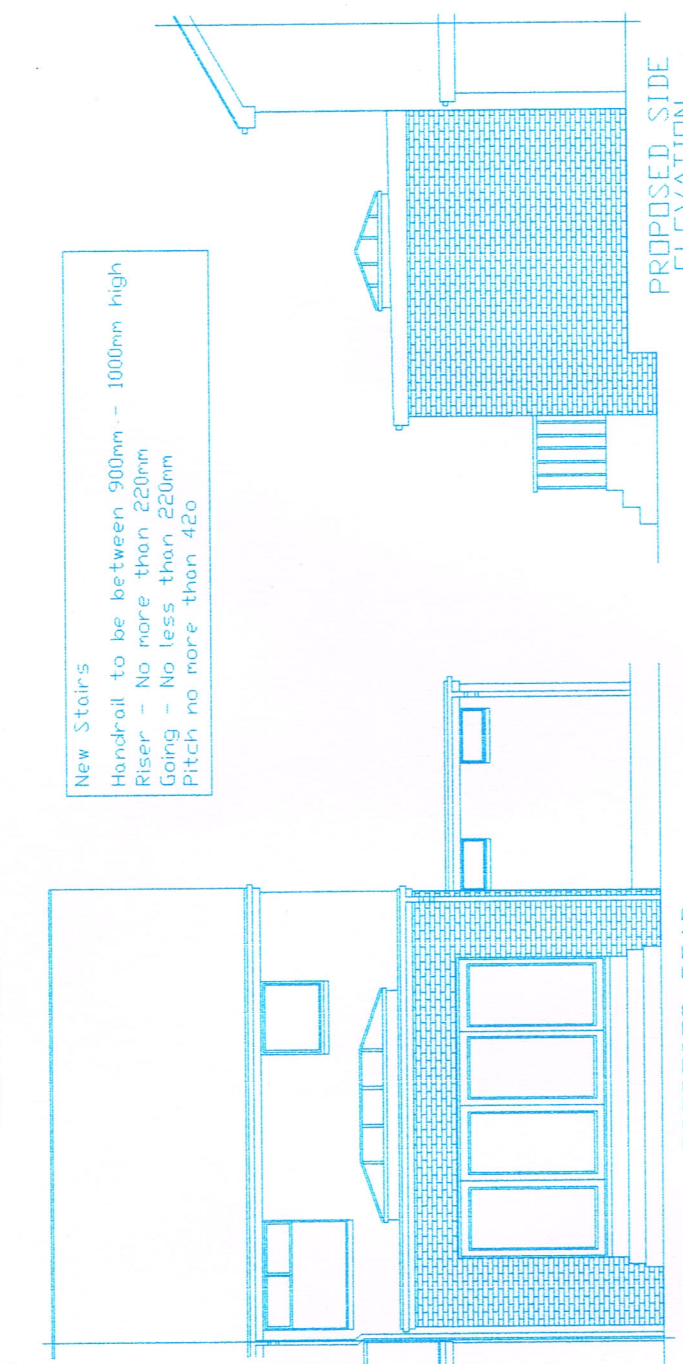
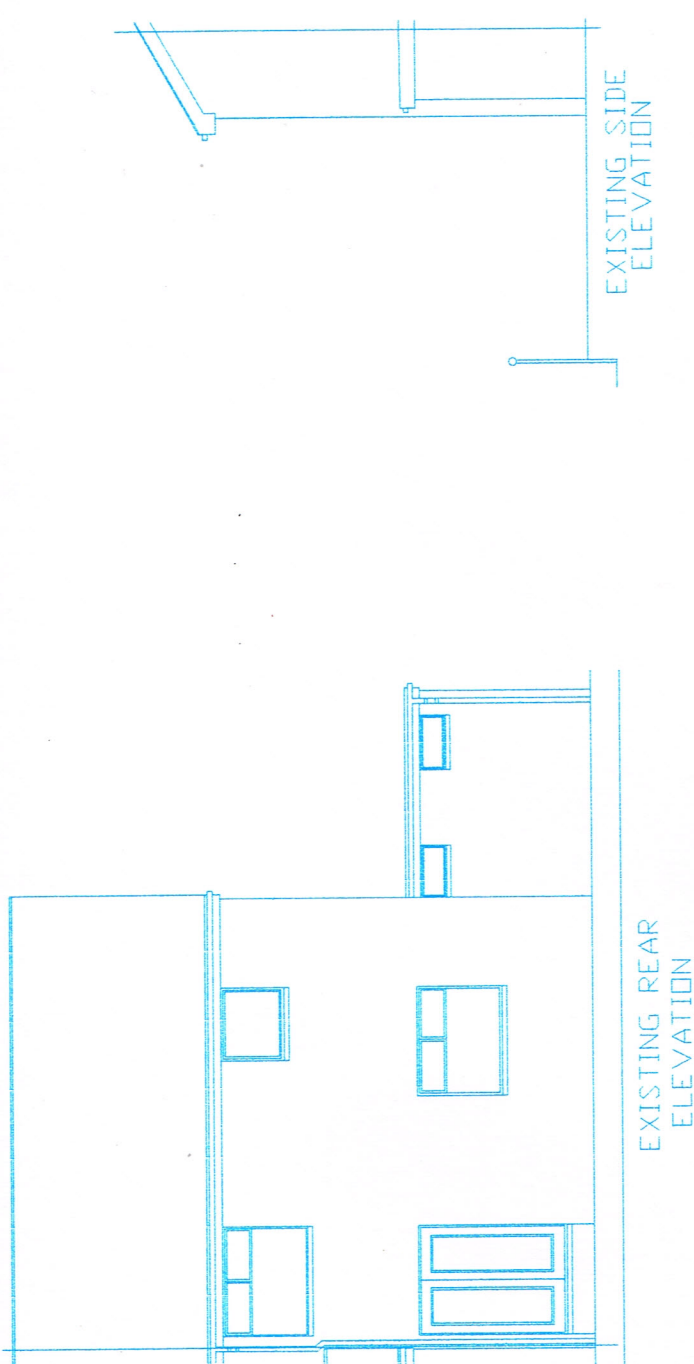

Safety Glazing to critical locations. New windows within 800mm from finished floor level. And to all new doors and adjoining windows (300mm either side) within 1500mm from finished floor level. SCALE BAR ORIGINAL DRAWING A3 SIZE. 12M @ 1:20, 3M @ 1:50, 6M @ 1:100. 12M @ 1:200, 30M @ 1:500, 75M @ 1:1250.