

▲ CLAY PLAIN TILES

 **Marley**



# CONTENTS

- 6 CLAY PLAIN TILE ROOF SYSTEMS
- 8 INNOVATION IN CLAY
- 10 CANTERBURY HANDMADE
- 16 ASHDOWNE HANDCRAFTED
- 22 ACME DOUBLE CAMBER
- 32 ACME SINGLE CAMBER
- 44 HAWKINS MACHINE-MADE
- 52 DETAILING CLAY PLAIN TILE ROOF SYSTEMS
- 54 BASE LAYERS
- 56 FITTINGS & ACCESSORIES
- 60 PROPERTIES & PERFORMANCE
- 62 DESIGN DETAILS
- 74 HERE TO HELP



Clay is a natural, durable and beautiful roofing material.

▲ The undulating roofline of the Quintain House disguises the complex and challenging roofing structure underneath. Marley's Acme Double Camber clay tiles deliver a highly textured, curved and seamless finish that highlights the roof's dramatic rises and falls, pushing the boundaries of traditional roofing. The result is a unique building that fits in with houses in nearby traditional villages, and exudes beauty and comfort."

ANDREW ROWLANDS, ROOFING CONTRACTOR, ROWLANDS ROOFING





# CLAY PLAIN TILE ROOF SYSTEMS

- ▲ We offer the most comprehensive roof system on the market today, underwritten by a 15 year warranty. Our complete, one-source roof system, gives levels of accountability and product integration that reduce specifier and contractor design and installation liability. More elements guaranteed to work seamlessly together, give you more time to focus on design and management of your project, complete peace of mind and, of course, better, easier-to-install, more durable, lower maintenance roofs.

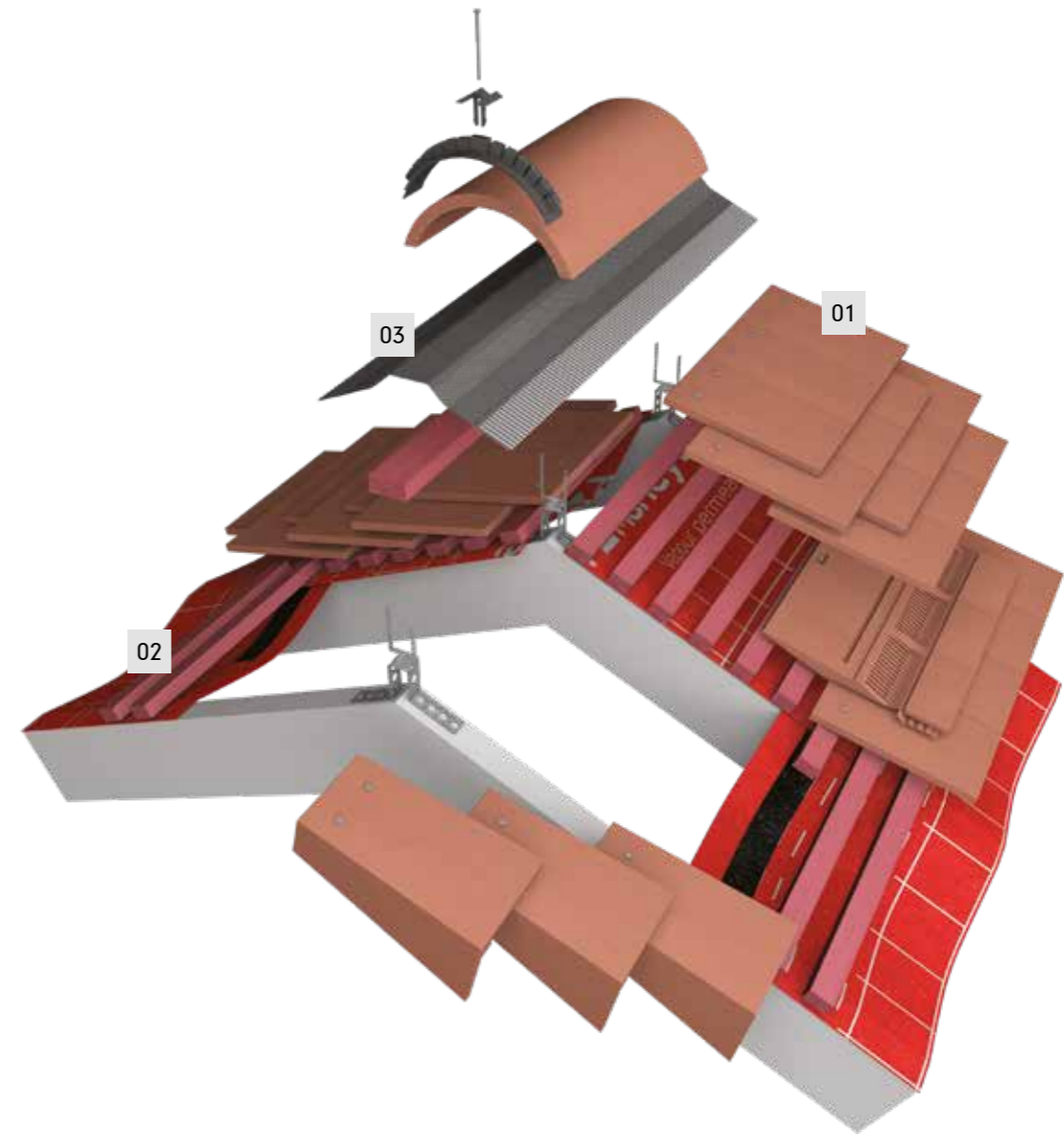

## 01/ ROOF COVERINGS

A range of clay plain tiles to suit every sector, pitch, geographical location and aesthetic requirement: at the same time complying with BS 5534 and BS 5250 and fully integrating with our base layers and dry fix systems to create a complete roof system.

- ▲ Clay plain tile range (pages 10-51)
- ▲ Properties and performance (pages 60-61)
- ▲ Case studies pages (14, 20-21, 26, 38-39 and 48)

## 02/ BASE LAYERS

With Universal permeable or non-breathable fully taped underlay and JB Red pre-graded BBA-certified battens, we offer BS 5534-compliant NHBC approved base layers that work seamlessly with all the other elements of our roof systems.

- ▲ Universal underlays (page 54)
- ▲ JB-Red battens (page 55)

## 03/ DETAILING

Dry fix BS 5534 and BS 5250-compliant systems for eaves, verge, valley hip, ridge abutment and other areas. These systems are made from high quality materials and tested together to work with our clay plain tile and other roof coverings to give secure, weathertight and durable finishing and detailing for our roof systems.

- ▲ Dry fix and ventilation systems (pages 52-53)
- ▲ Fittings and accessories (pages 56-59)
- ▲ Design details pages (pages 62-73)

## KNOWLEDGE

A key part of our roof system is ease of access to tools and knowledge that make the design, specification and fixing process easier and faster. Our suite of free-to-use online tools is designed to get our knowledge into your designs and specs quickly and easily.

- ▲ Resources (pages 74-75)

## WARRANTY

Our 15 year warranty covers more pitched roofing elements than any other manufacturer and gives the ultimate assurance that our integrated roofing solutions can be specified and installed with complete confidence.

- ▲ For more information visit [marley.co.uk/resources](http://marley.co.uk/resources)



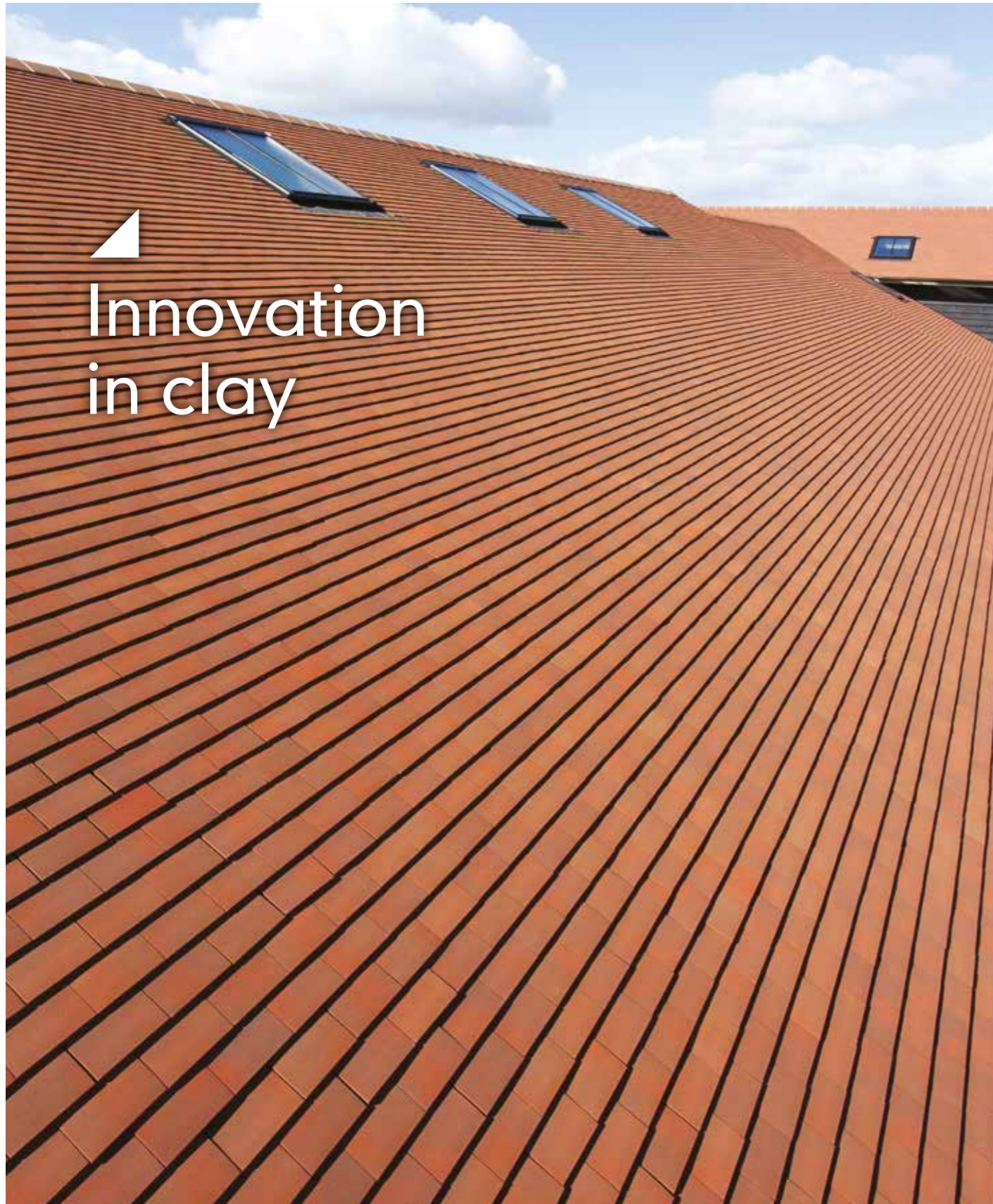

## ▲ Innovation in clay

Plain tiles made from clay have been used to cover roofs in Britain for over eight hundred years and they form much of the character of the roofs seen in the South East of England and the Midlands, where the largest deposits of clay are located.

Our extensive range contains colour, texture and camber options which meet the aesthetic and performance demands of all types of roofing applications.

- ▲ BES 6001 'Excellent' rating and A+ rated in the BRE Green Guide
- ▲ Durable, natural material
- ▲ Full range of colours and finishes
- ▲ 30° low pitch options
- ▲ Full range of fittings and accessories
- ▲ Independent carbon footprint certification
- ▲ Premium range of handmade tiles



# CANTERBURY

## HANDMADE CLAY PLAIN TILES

Nothing compares to handmade clay plain tiles. That's why our range of Canterbury handmade roof tiles are created true to tradition. For extra versatility, the colour range can be mixed together on the roof to create your own personal blend.

### TECHNICAL TOOLKIT

Marley provides a comprehensive technical service and a range of online tools to ensure design performance and compliance to the latest British Standards and NHBC technical guidelines. These services include:

- ▲ Fixing specifications: [marley.co.uk/tilefix](http://marley.co.uk/tilefix)
- ▲ NBS clauses: [marley.co.uk/specrite](http://marley.co.uk/specrite)
- ▲ CAD details: [marley.co.uk/cad](http://marley.co.uk/cad)
- ▲ BIM models: [marley.co.uk/bim](http://marley.co.uk/bim)

For more information on the recent update to the British Standard for Slating and Tiling (BS 5534) and how it might affect your project, please visit [marley.co.uk/BS5534](http://marley.co.uk/BS5534)

### FEATURE TILES

Available in a range of colours. For advice on the use of feature tiles in main roof areas, contact the Technical Advisory Service.

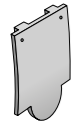

Club



Bullnose



### COLOUR AVAILABILITY

See pages 12-15 for more detailed colour panels.

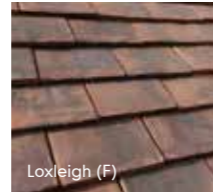

Key: (F) Fine sanded finish

### TECHNICAL DATA

Size of tile	265mm x 165mm	
Minimum pitch*	40°	
Maximum pitch	90°	
Minimum headlap	65mm (roof)	35mm (vertical)
Maximum gauge	100mm (roof)	115mm (vertical)
Cover width	165mm (nominal)	
Tile thickness	13mm (nominal)	
Covering capacity (net)	60 tiles/m <sup>2</sup> at 100mm gauge (roof) 53 tiles/m <sup>2</sup> at 115mm gauge (vertical)	
Weight of tiling (approx.)	74kg/m <sup>2</sup> (0.73 kN/m <sup>2</sup> ) at 100mm gauge (roof) 66kg/m <sup>2</sup> (0.64 kN/m <sup>2</sup> ) at 115mm gauge (vertical)	
Battens required (net)	10.0 lin.m/m <sup>2</sup> at 100mm gauge (roof) 8.7 lin.m/m <sup>2</sup> at 115mm gauge (vertical)	
Batten size recommended	38 x 25mm for rafters/supports not exceeding 600mm centres (fixed to BS 5534)	
Tile nails	38mm x 2.65mm	
Authority	BS EN 1304	

\* The minimum recommended pitch and lap may be influenced by special circumstances, please contact the Technical Advisory Service.

### SUSTAINABILITY

Green guide rating	A+ (Element ref: 812410006)
BES 6001	Excellent- can achieve 3 credits





## CANTERBURY LOXLEIGH FINE SANDED FINISH



## DENHAM CASE STUDY

### PROJECT INFORMATION

Location/  
Denham

Application/  
Residential

Product/  
Canterbury Loxleigh



Canterbury handmade clay plain tiles in Loxleigh colour have been used to create an authentic roof for a new build historic-style cottage in the Denham conservation area. The self-build project, in the picturesque old English village, had to adhere to strict planning guidelines for roof height and use of materials due to the number of listed buildings along the same road.

▲ Find more case studies at [marley.co.uk/casestudies](https://www.marley.co.uk/casestudies)



# ASHDOWNNE

## HANDCRAFTED CLAY PLAIN TILES



Ashdownne handcrafted clay plain tiles offer all the warmth and mellow appearance of traditional handmade tiles, with a granular texture and slight random irregularities that make each tile unique.

### TECHNICAL TOOLKIT

Marley provides a comprehensive technical service and a range of online tools to ensure design performance and compliance to the latest British Standards and NHBC technical guidelines. These services include:

- ▲ Fixing specifications: [marley.co.uk/tilefix](http://marley.co.uk/tilefix)
- ▲ NBS clauses: [marley.co.uk/specrite](http://marley.co.uk/specrite)
- ▲ CAD details: [marley.co.uk/cad](http://marley.co.uk/cad)
- ▲ BIM models: [marley.co.uk/bim](http://marley.co.uk/bim)

For more information on the recent update to the British Standard for Slating and Tiling (BS 5534) and how it might affect your project, please visit [marley.co.uk/BS5534](http://marley.co.uk/BS5534)

### FEATURE TILES

Available in a range of colours. For advice on the use of feature tiles in main roof areas, contact the Technical Advisory Service.

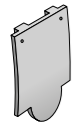

Club



Bullnose

### COLOUR AVAILABILITY

See pages 18-19 for more detailed colour panels.

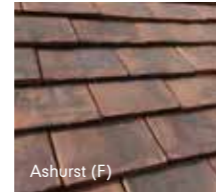

Ashurst (F)



Aylesham Mix (F)

Key: (F) Fine sanded finish

### TECHNICAL DATA

Size of tile	265mm x 165mm	
Minimum pitch*	35°	
Maximum pitch	90°	
Minimum headlap	65mm (roof)	35mm (vertical)
Maximum gauge	100mm (roof)	115mm (vertical)
Cover width	165mm (nominal)	
Tile thickness	11mm (nominal)	
Covering capacity (net)	60 tiles/m <sup>2</sup> at 100mm gauge (roof) 53 tiles/m <sup>2</sup> at 115mm gauge (vertical)	
Weight of tiling (approx.)	65kg/m <sup>2</sup> (0.64 kN/m <sup>2</sup> ) at 100mm gauge (roof) 57kg/m <sup>2</sup> (0.56 kN/m <sup>2</sup> ) at 115mm gauge (vertical)	
Battens required (net)	10.0 lin.m/m <sup>2</sup> at 100mm gauge (roof) 8.7 lin.m/m <sup>2</sup> at 115mm gauge (vertical)	
Batten size recommended	38 x 25mm for rafters/supports not exceeding 600mm centres (fixed to BS 5534)	
Tile nails	38mm x 2.65mm	
Authority	BS EN 1304	

\* The minimum recommended pitch and lap may be influenced by special circumstances, please contact the Technical Advisory Service.

### SUSTAINABILITY

Green guide rating	A+ (Element ref: 812410006)
BES 6001	Excellent- can achieve 3 credits
Embodied carbon	Carbon footprint of 28 KgCO <sub>2</sub> e/m <sup>2</sup> at 100mm gauge





ASHDOWNE ASHURST  
FINE SANDED FINISH



ASHDOWNE AYLESHAM MIX  
FINE SANDED FINISH





## THE CLOISTERS CASE STUDY



▲ The weathered appearance of these beautiful handcrafted clay plain tiles help the new houses blend into their surroundings and give a premium handmade finish.

Ashdowne Handcrafted Clay Plain Tiles in Aylesham Mix give a handmade appearance on the roof of these prestigious houses in Stanmore Country Park ranging from £2.4 to £3.8m in value. Located in a conservation area close to the capital, Signia (part of Jaysam Developments) specified Ashdowne handcrafted tiles to meet with strict planning requirements for this sensitive site.

▲ Find more case studies at [marley.co.uk/casestudies](https://marley.co.uk/casestudies)

### PROJECT INFORMATION

Location/  
Stanmore

Application/  
Residential

Product/  
Ashdowne (Aylesham Mix)

Specifier/  
Signia Homes



# ACME DOUBLE CAMBER CLAY PLAIN TILES



Acme double camber clay plain tiles have both a longitudinal and latitudinal camber, which accentuates light and shade and creates highly textured roofscapes.

## TECHNICAL TOOLKIT

Marley provides a comprehensive technical service and a range of online tools to ensure design performance and compliance to the latest British Standards and NHBC technical guidelines. These services include:

- ▲ Fixing specifications: [marley.co.uk/tilefix](http://marley.co.uk/tilefix)
- ▲ NBS clauses: [marley.co.uk/specrite](http://marley.co.uk/specrite)
- ▲ CAD details: [marley.co.uk/cad](http://marley.co.uk/cad)
- ▲ BIM models: [marley.co.uk/bim](http://marley.co.uk/bim)

For more information on the recent update to the British Standard for Slating and Tiling (BS 5534) and how it might affect your project, please visit [marley.co.uk/BS5534](http://marley.co.uk/BS5534)

## FEATURE TILES

Available in a range of colours. For advice on the use of feature tiles in main roof areas, contact the Technical Advisory Service.

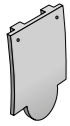

Club



Bullnose

## COLOUR AVAILABILITY

See pages 24-31 for more detailed colour panels.



Key: (F) Fine sanded finish (S) Smooth finish

## TECHNICAL DATA

Size of tile	265mm x 165mm	
Minimum pitch*	35°	
Maximum pitch	90°	
Minimum headlap	65mm (roof)	35mm (vertical)
Maximum gauge	100mm (roof)	115mm (vertical)
Cover width	165mm (nominal)	
Tile thickness	11mm (nominal)	
Covering capacity (net)	60 tiles/m <sup>2</sup> at 100mm gauge (roof) 53 tiles/m <sup>2</sup> at 115mm gauge (vertical)	
Weight of tiling (approx.)	64kg/m <sup>2</sup> (0.63 kN/m <sup>2</sup> ) at 100mm gauge (roof) 56kg/m <sup>2</sup> (0.55 kN/m <sup>2</sup> ) at 115mm gauge (vertical)	
Battens required (net)	10.0 lin.m/m <sup>2</sup> at 100mm gauge (roof) 8.7 lin.m/m <sup>2</sup> at 115mm gauge (vertical)	
Batten size recommended	38 x 25mm for rafters/supports not exceeding 600mm centres (fixed to BS 5534)	
Tile nails	38mm x 2.65mm	
Authority	BS EN 1304	

\* The minimum recommended pitch and lap may be influenced by special circumstances, please contact the Technical Advisory Service.

## SUSTAINABILITY

Green guide rating	A+ (Element ref: 812410006)
BES 6001	Excellent – can achieve 3 credits
Embodied carbon	Carbon footprint of 27 KgCO <sub>2</sub> e/m <sup>2</sup> at 100mm gauge





# BEACONSFIELD 11

## CASE STUDY

# ACME DOUBLE CAMBER

## BURNT FLAME

### SMOOTH FINISH

#### PROJECT INFORMATION

Location/  
Buckinghamshire

Application/  
Residential

Product/  
Acme Double Camber  
in Burnt Flame

Specifier/  
EAB Homes and  
Developments Ltd



Marley's Acme Double Camber Clay Plain Tile in Burnt Flame has been used by EAB Homes and Developments Ltd on their award-winning development in Beaconsfield, Buckinghamshire..

▲ Find more case studies at [marley.co.uk/casestudies](https://marley.co.uk/casestudies)





# QUINTAIN HOUSE

## CASE STUDY

### PROJECT INFORMATION

Location/  
Gloucestershire

Application/  
Residential

Product/  
Acme Double Camber  
in Burnt Flame

Specifier/  
Kirkland Fraser Moor



Quintain House's clay tiled roof is sympathetic to those in nearby traditional villages in the surrounding area. Its striking undulating form was very challenging on a technical level and was achieved using Acme Double Camber clay plain tiles in Burnt Flame, demonstrating their versatility in creating complex roof designs.

▲ Find more case studies at [marley.co.uk/casestudies](https://marley.co.uk/casestudies)

# ACME DOUBLE CAMBER

## ANTIQUÉ

### FINE SANDED FINISH

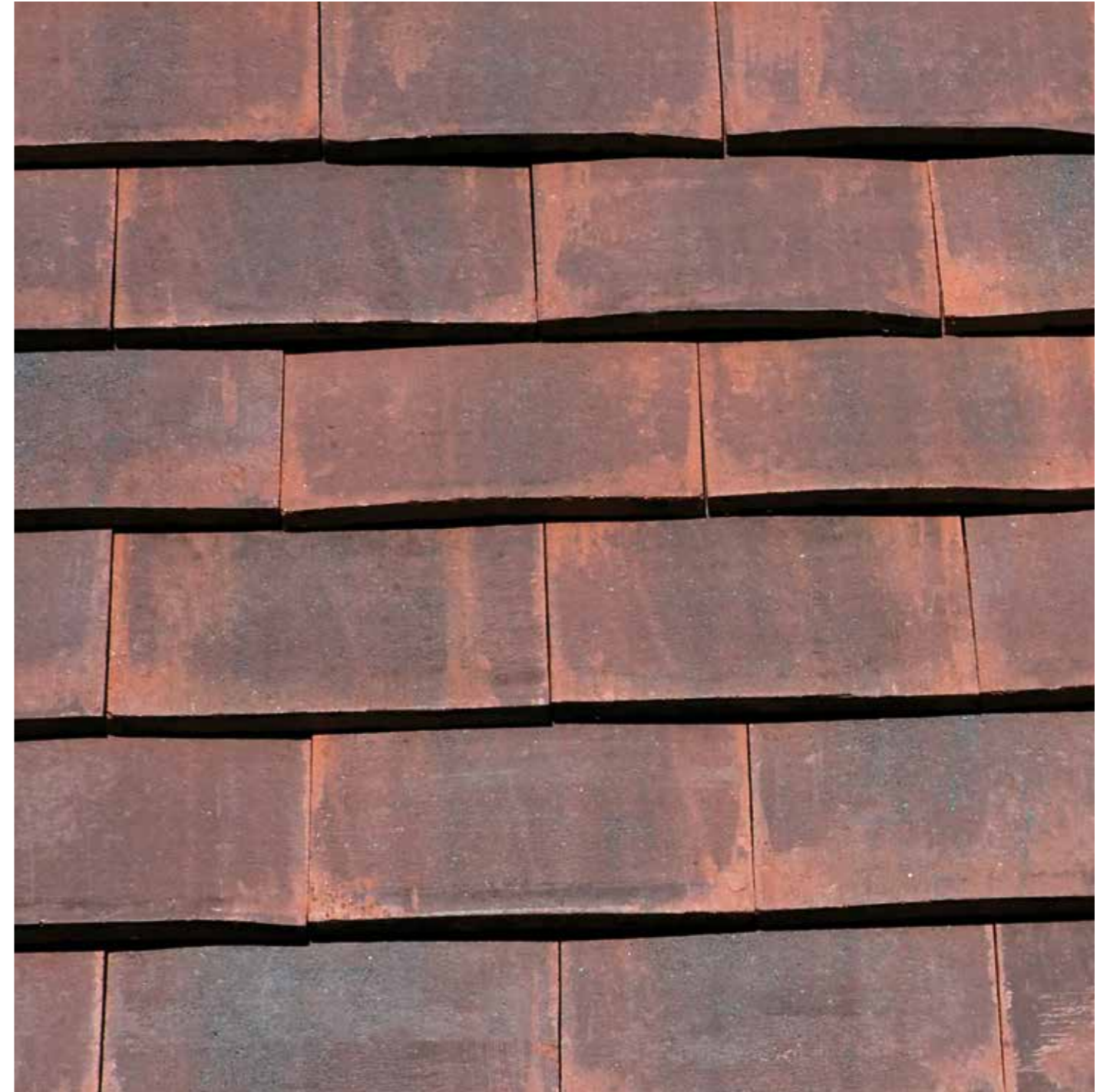



ACME DOUBLE CAMBER  
SMOOTH BRINDLE  
SMOOTH FINISH

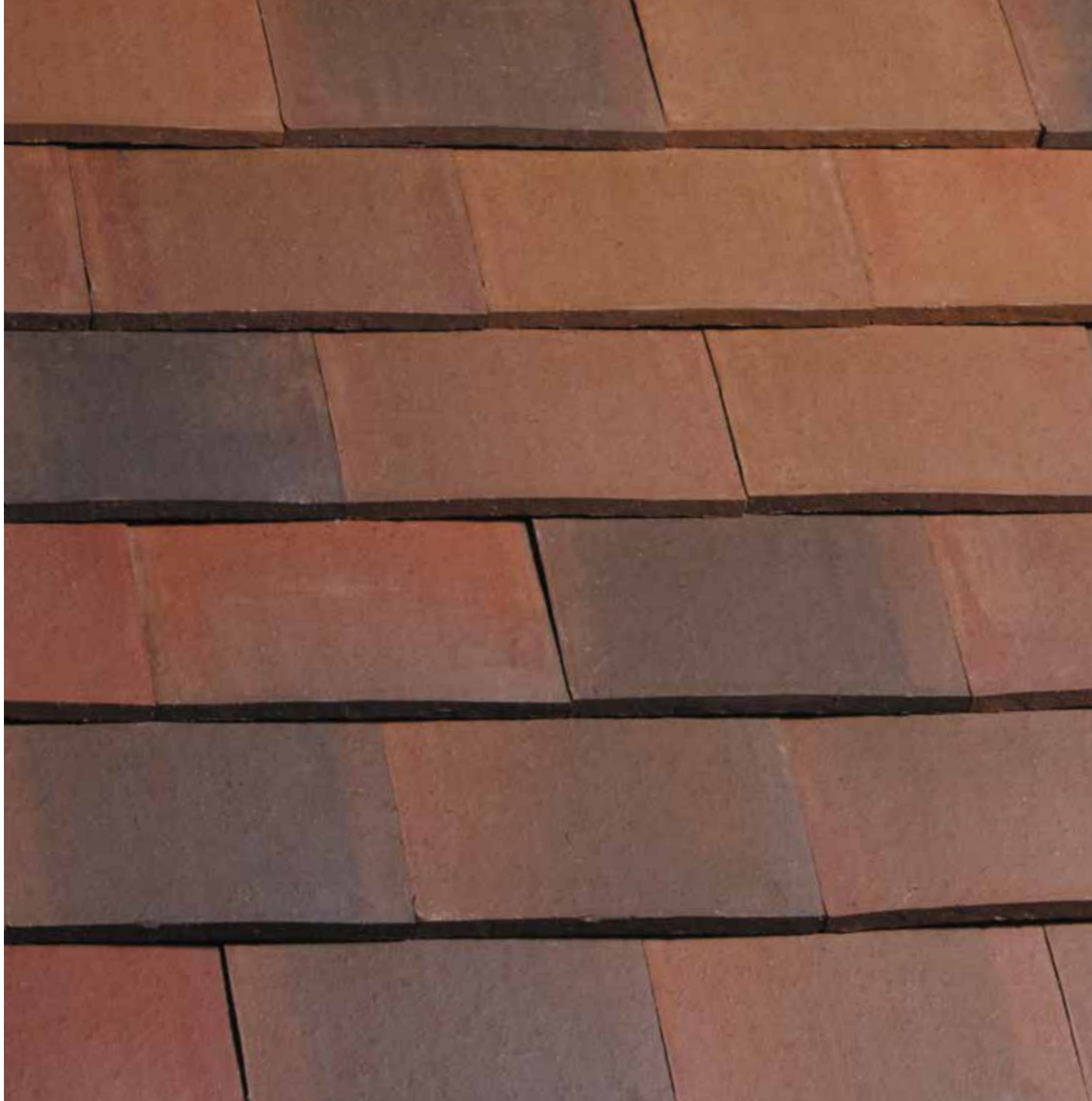

ACME DOUBLE CAMBER  
DARK BRINDLE  
SMOOTH FINISH

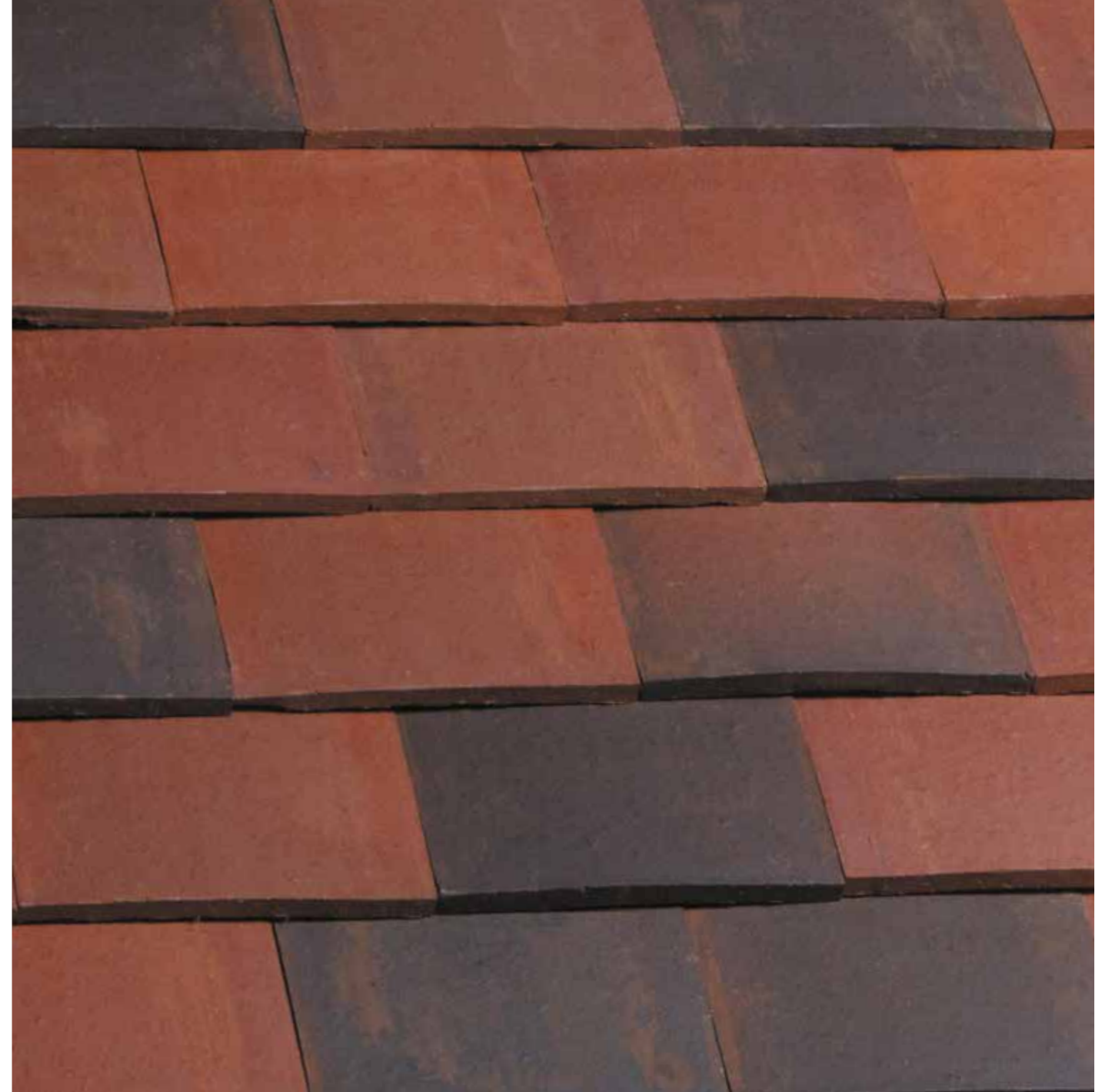



# ACME SINGLE CAMBER CLAY PLAIN TILES



The Acme single camber clay plain tile allows the creation of traditional and contemporary low pitch roof designs with the warmth and character of clay.

## TECHNICAL TOOLKIT

Marley provides a comprehensive technical service and a range of online tools to ensure design performance and compliance to the latest British Standards and NHBC technical guidelines. These services include:

- ▲ Fixing specifications: [marley.co.uk/tilefix](http://marley.co.uk/tilefix)
- ▲ NBS clauses: [marley.co.uk/specrite](http://marley.co.uk/specrite)
- ▲ CAD details: [marley.co.uk/cad](http://marley.co.uk/cad)
- ▲ BIM models: [marley.co.uk/bim](http://marley.co.uk/bim)

For more information on the recent update to the British Standard for Slating and Tiling (BS 5534) and how it might affect your project, please visit [marley.co.uk/BS5534](http://marley.co.uk/BS5534)

## FEATURE TILES

Available in a range of colours. For advice on the use of feature tiles in main roof areas, contact the Technical Advisory Service.

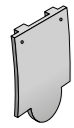

Club



Bullnose

## COLOUR AVAILABILITY

See pages 34-43 for more detailed colour panels.

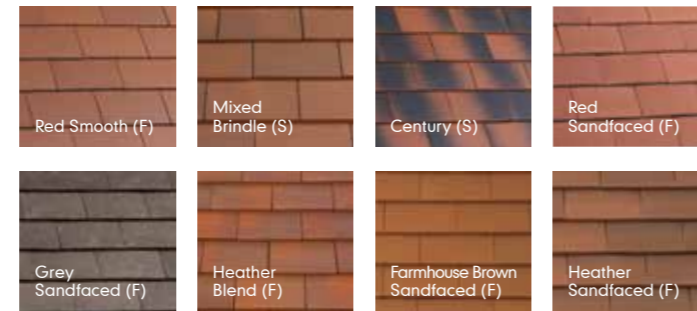

Key: (F) Fine sanded finish (S) Smooth finish

## TECHNICAL DATA

Size of tile	265mm x 165mm	
Minimum pitch*	30°	
Maximum pitch	90°	
Minimum headlap	65mm (roof)	35mm (vertical)
Maximum gauge	100mm (roof)	115mm (vertical)
Cover width	165mm (nominal)	
Tile thickness	11mm (nominal)	
Covering capacity (net)	60 tiles/m <sup>2</sup> at 100mm gauge (roof) 53 tiles/m <sup>2</sup> at 115mm gauge (vertical)	
Weight of tiling (approx.)	64kg/m <sup>2</sup> (0.63 kN/m <sup>2</sup> ) at 100mm gauge (roof) 56kg/m <sup>2</sup> (0.55 kN/m <sup>2</sup> ) at 115mm gauge (vertical)	
Battens required (net)	10.0 lin.m/m <sup>2</sup> at 100mm gauge (roof) 8.7 lin.m/m <sup>2</sup> at 115mm gauge (vertical)	
Batten size recommended	38 x 25mm for rafters/supports not exceeding 600mm centres (fixed to BS 5534)	
Tile nails	38mm x 2.65mm	
Authority	BS EN 1304	

\* The minimum recommended pitch and lap may be influenced by special circumstances, please contact the Technical Advisory Service.

## SUSTAINABILITY

Green guide rating	A+ (Element ref: 812410006)
BES 6001	Excellent– can achieve 3 credits
Embodied carbon	Carbon footprint of 27 KgCO <sub>2</sub> e/m <sup>2</sup> at 100mm gauge

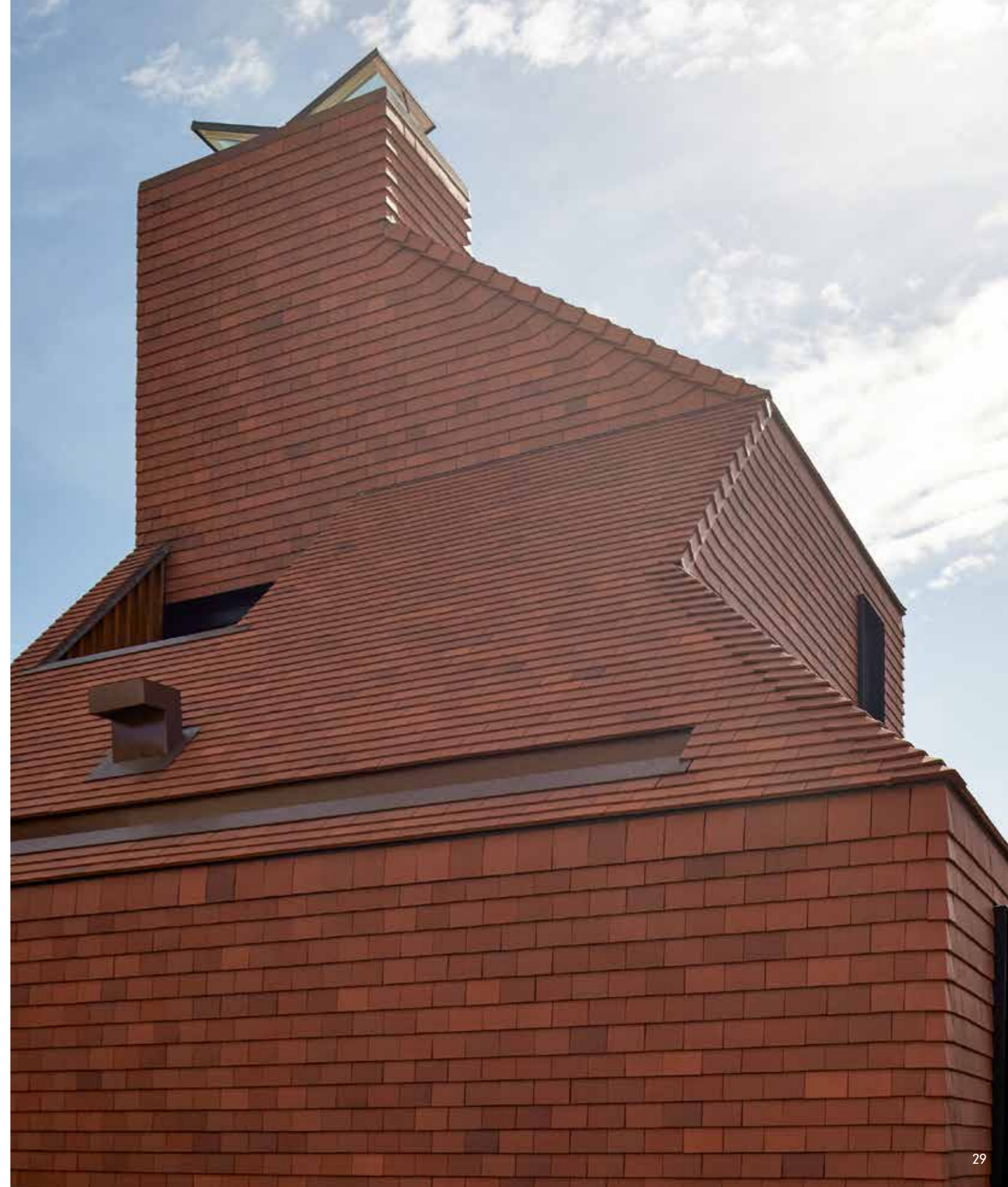



ACME SINGLE CAMBER  
RED SMOOTH  
SMOOTH FINISH



ACME SINGLE CAMBER  
CENTURY  
SMOOTH FINISH

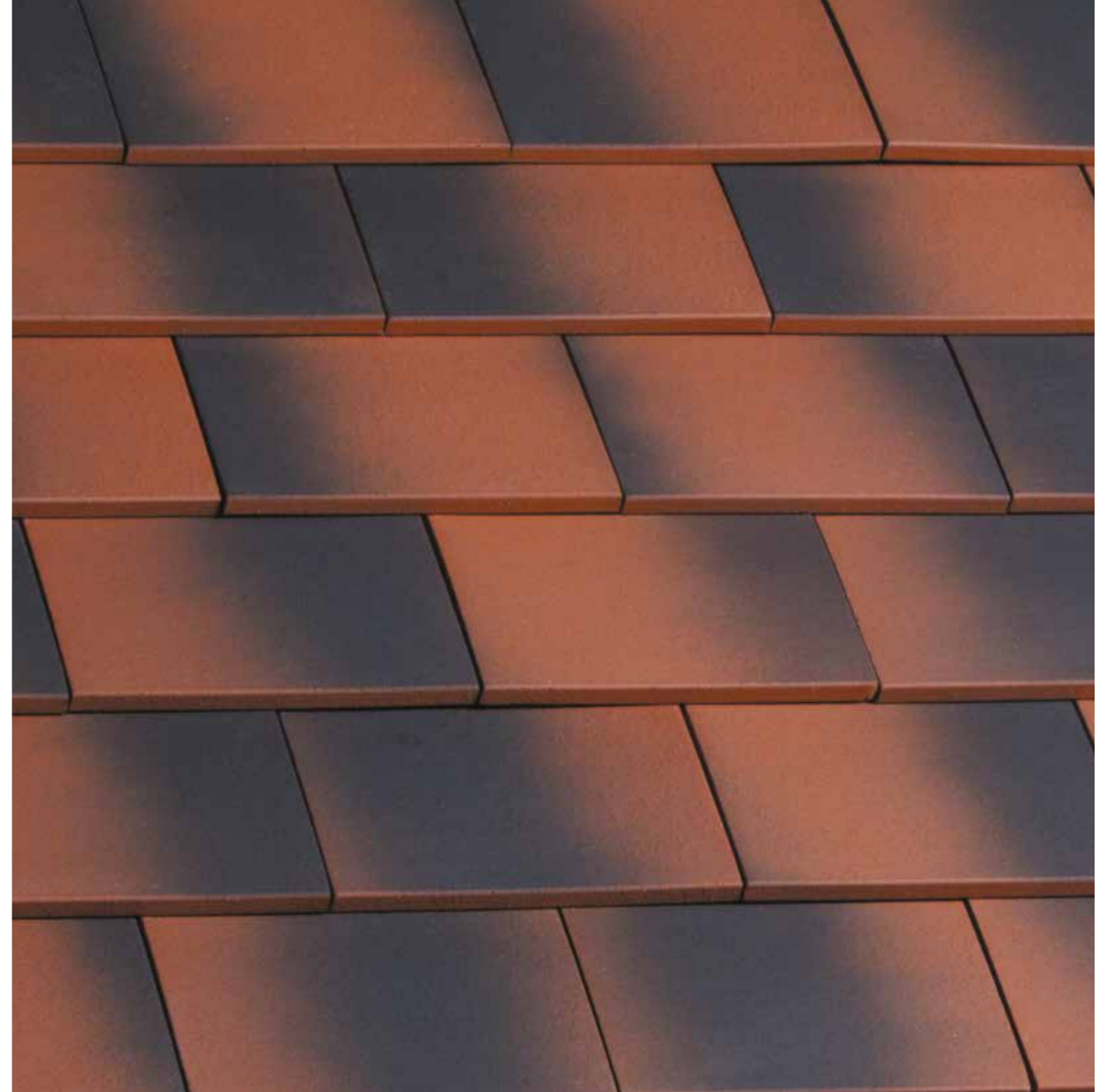



ACME SINGLE CAMBER  
MIXED BRINDLE  
SMOOTH FINISH



ACME SINGLE CAMBER  
RED SANDFACED  
FINE SANDED FINISH





## POACHER'S RETREAT CASE STUDY



▲ The environmentally sustainable aspect of the range featured highly on the product selection criteria. We also felt it was important to choose tiles that were made in the country where they are to be used and that they stand the test of time and work with the climate.”

MALCOLM COX, HOMEOWNER

This idyllic home set in its own country grounds needed a traditional tile with a strong performance. The Acme Single Camber Clay Tile ability to drop to 30° minimum pitch provided great versatility for the designers and contractors to work with.

▲ Find more case studies at [marley.co.uk/casestudies](https://marley.co.uk/casestudies)

### PROJECT INFORMATION

Location/  
South

Application/  
Residential

Product/  
Acme Single Camber  
(Grey Sandfaced)

Specifier/  
Malcolm Cox



ACME SINGLE CAMBER  
GREY SANDFACED  
SMOOTH FINISH

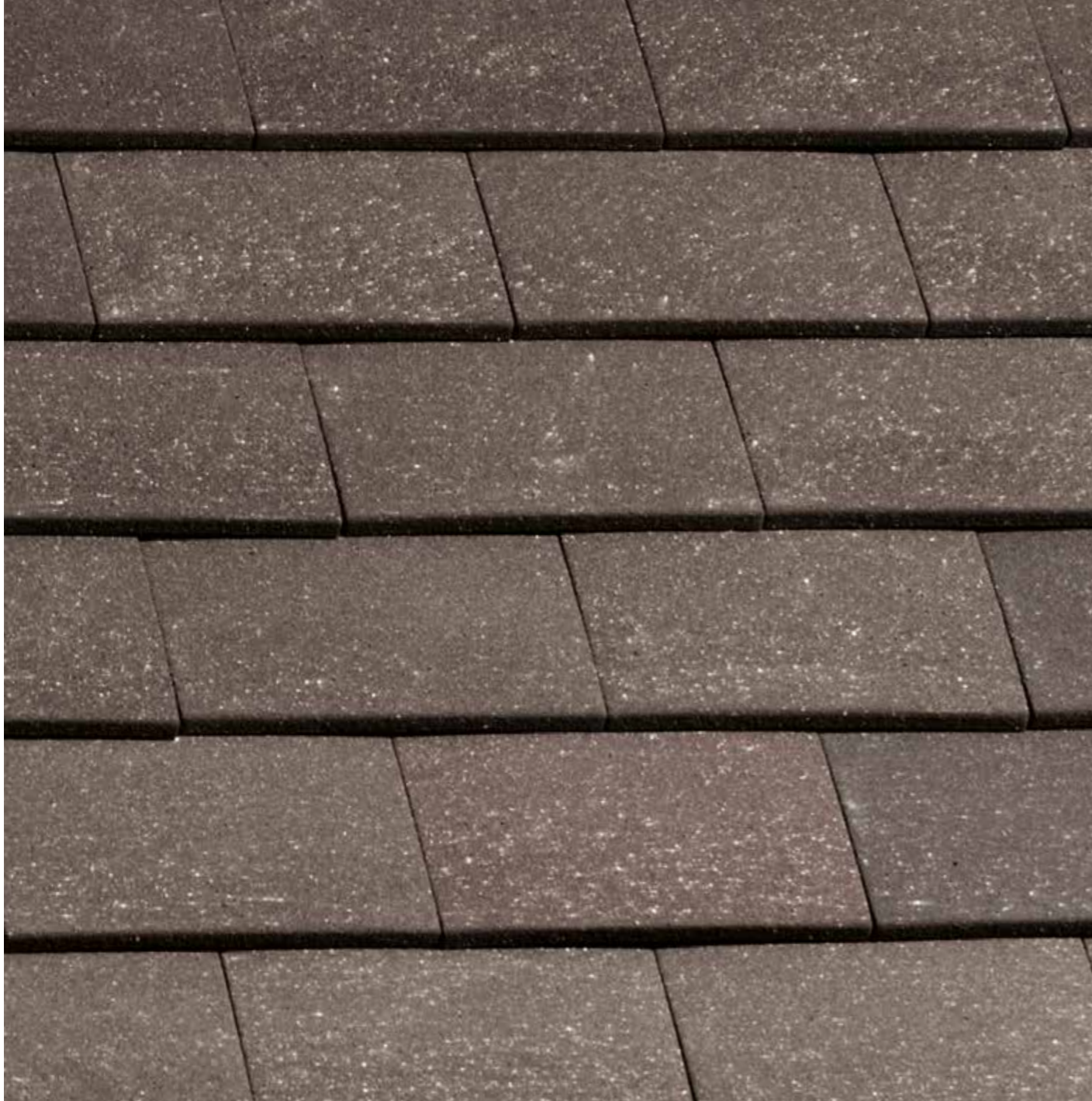

ACME SINGLE CAMBER  
FARMHOUSE BROWN SANDFACED  
FINE SANDED FINISH

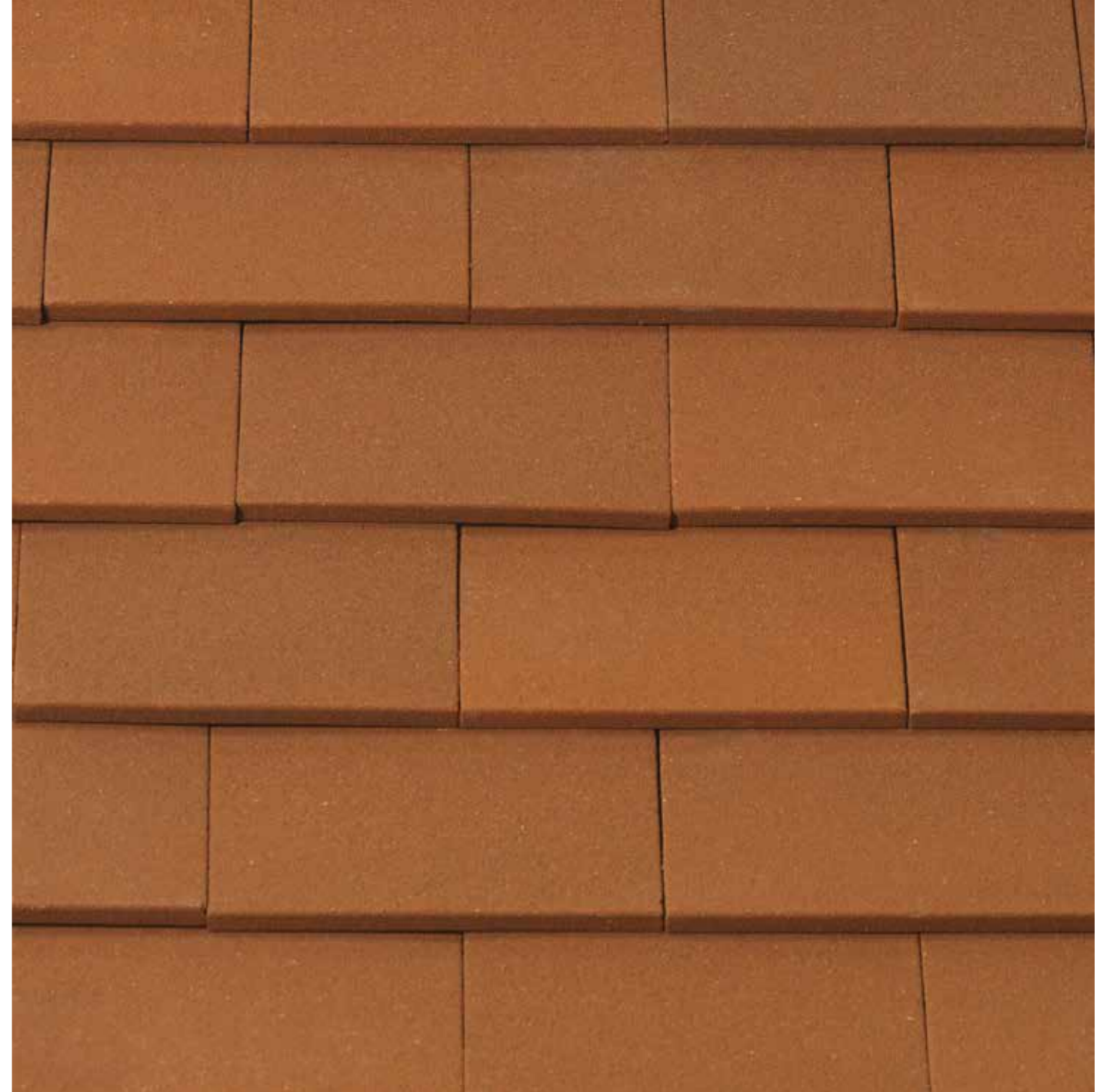



ACME SINGLE CAMBER  
HEATHER BLEND  
FINE SANDED FINISH



ACME SINGLE CAMBER  
HEATHER SANDFACED  
FINE SANDED FINISH





# HAWKINS

## MACHINE-MADE CLAY PLAIN TILES



The name 'Hawkins' has been synonymous with quality roofs for over 150 years. This heritage, combined with our modern firing techniques, gives a unique colour range.

### TECHNICAL TOOLKIT

provides a comprehensive technical service and a range of online tools to ensure design performance and compliance to the latest British Standards and NHBC technical guidelines. These services include:

- ▲ Fixing specifications: [marley.co.uk/tilefix](http://marley.co.uk/tilefix)
- ▲ NBS clauses: [marley.co.uk/specrite](http://marley.co.uk/specrite)
- ▲ CAD details: [marley.co.uk/cad](http://marley.co.uk/cad)
- ▲ BIM models: [marley.co.uk/bim](http://marley.co.uk/bim)

For more information on the recent update to the British Standard for Slating and Tiling (BS 5534) and how it might affect your project, please visit [marley.co.uk/BS5534](http://marley.co.uk/BS5534)

### FEATURE TILES

Available in a range of colours. For advice on the use of feature tiles in main roof areas, contact the Technical Advisory Service.

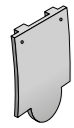

Club



Bullnose

### COLOUR AVAILABILITY

See pages 46-51 for more detailed colour panels.

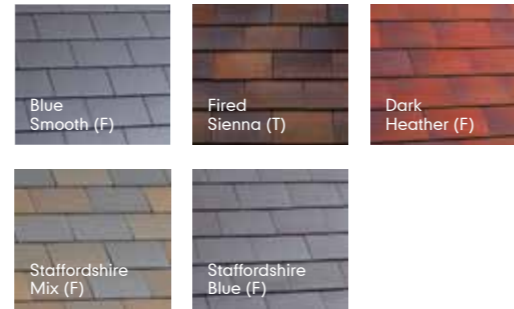

Key: (F) Fine sanded finish (S) Smooth finish (T) Textured finish

### TECHNICAL DATA

Size of tile	265mm x 165mm	
Minimum pitch*	30°	
Maximum pitch	90°	
Minimum headlap	65mm (roof)	35mm (vertical)
Maximum gauge	100mm (roof)	115mm (vertical)
Cover width	165mm (nominal)	
Tile thickness	11mm (nominal)	
Covering capacity (net)	60 tiles/m <sup>2</sup> at 100mm gauge (roof) 53 tiles/m <sup>2</sup> at 115mm gauge (vertical)	
Weight of tiling (approx.)	64kg/m <sup>2</sup> (0.63 kN/m <sup>2</sup> ) at 100mm gauge (roof) 56kg/m <sup>2</sup> (0.55 kN/m <sup>2</sup> ) at 115mm gauge (vertical)	
Battens required (net)	10.0 lin.m/m <sup>2</sup> at 100mm gauge (roof) 8.7 lin.m/m <sup>2</sup> at 115mm gauge (vertical)	
Batten size recommended	38 x 25mm for rafters/supports not exceeding 600mm centres (fixed to BS 5534)	
Tile nails	38mm x 2.65mm	
Authority	BS EN 1304	

\* The minimum recommended pitch and lap may be influenced by special circumstances, please contact the Technical Advisory Service.

### SUSTAINABILITY

Green guide rating	A <sup>+</sup> (Element ref: 812410006)
BES 6001	Excellent – can achieve 3 credits
Embodied carbon	Carbon footprint of 33 KgCO <sub>2</sub> e/m <sup>2</sup> at 100mm gauge





HAWKINS BLUE SMOOTH  
SMOOTH FINISH



HAWKINS DARK HEATHER  
FINE SANDED FINISH





# MALVERN CHURCH

## CASE STUDY



### PROJECT INFORMATION

Location/  
Midlands

Application/  
Refurbishment

Product/  
Hawkins Fired Sienna

Specifier/  
Nick Joyce Architects

The unique weathered texture was the deciding factor in the specification of Fired Sienna for this renovation. Following a successful restoration appeal, the Baptist Church wanted a reclaimed look about the finished roof whilst ensuring it would last for years to come.

▲ Find more case studies at [marley.co.uk/casestudies](http://marley.co.uk/casestudies)

# HAWKINS FIRED SIENNA

## TEXTURED FINISH





HAWKINS STAFFORDSHIRE MIX  
SMOOTH FINISH

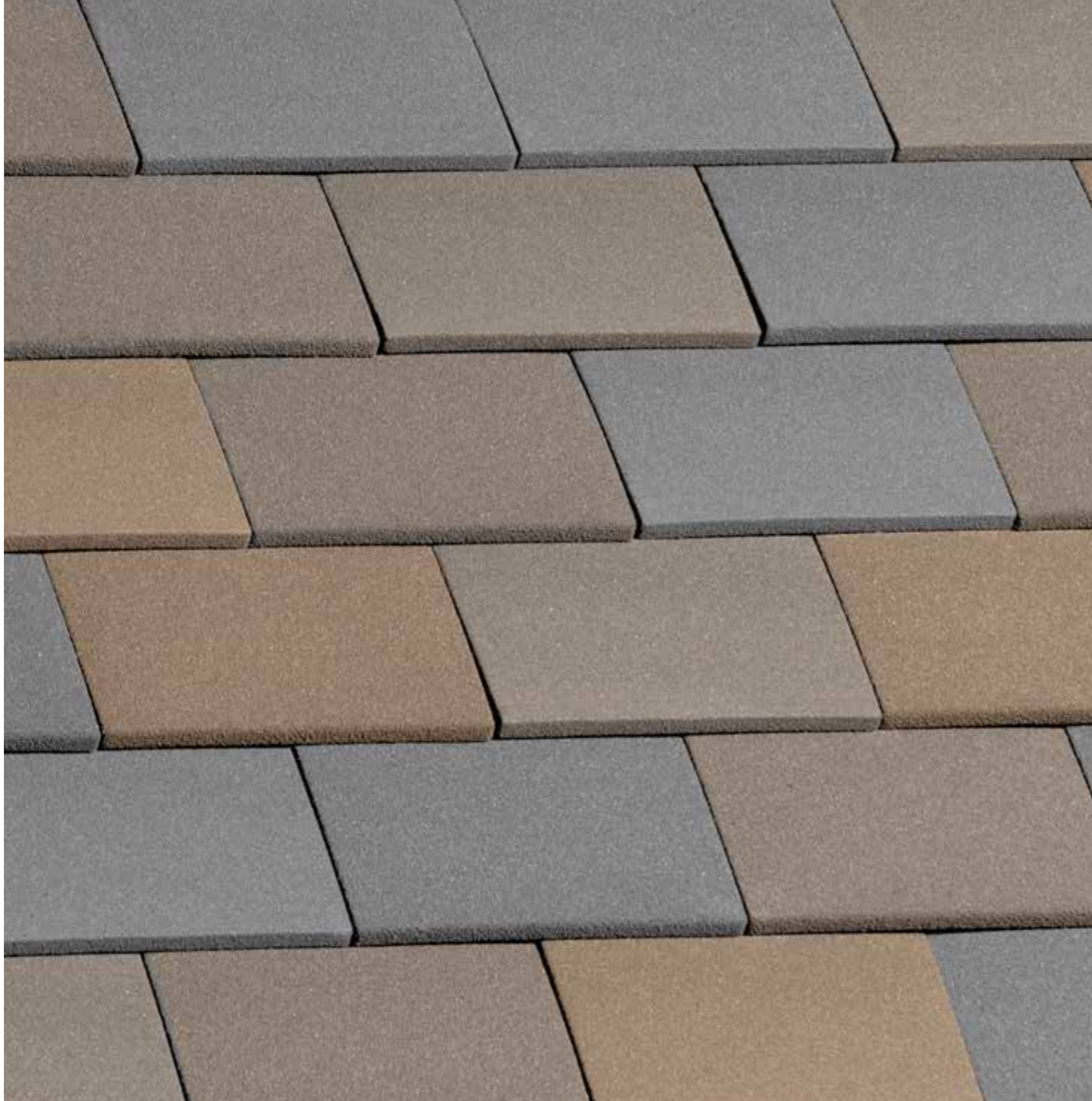

HAWKINS STAFFORDSHIRE BLUE  
FINE SANDED FINISH





# DETAILING CLAY PLAIN TILE ROOF SYSTEMS

▲ We at Marley design our roofing products as holistic systems. Our dry fix and ventilation solutions are a key part of our roof system, enabling flexibility in design and detailing; offering weatherproofing, security and refined aesthetics, as well as providing excellent levels of ventilation.

They are also quick, straightforward and economical to install, and for the building owner, they require minimal ongoing maintenance but give maximum durability and long life.

## MARLEY DRY FIX SYSTEMS

To improve the speed and economy of roof construction, a choice of high performance, maintenance-free dry fix systems are offered to suit ridge, verge, hip and valley details providing easy to fix alternatives to traditional mortar bedding. When correctly installed, they are designed to satisfy the requirements of BS 5534 'Code of practice for slating and tiling' with respect to the mechanical fixing of roof fittings to resist wind uplift and the provision of a weathertight roof.

**Available systems:** Universal RidgeFast, Universal HipFast, Dry Hip system, Dry ridge and mono ridge, Universal plain tile dry verge system, Cloak verge tiles, Universal GRP Dry valley, Bonding gutters.

## MARLEY VENTILATION SYSTEMS

To assist the designer in meeting the requirements of the Building Regulations, Marley has developed a range of ventilation accessories that combine discreet and aesthetic solutions with the highly efficient removal of moisture-laden air and gases. This comprehensive range is designed to ventilate roof voids with terminals for the ridge and roof, with connection to mechanical extract systems and soil vent pipes, allowing easy provision of precise amounts of free airspace.

**Available systems:** Universal eaves ventilation systems (10 and 25mm), Universal RidgeFast, Universal HipFast, Ventilated dry ridge and mono ridge, Ridge vent terminals, In-line vents.

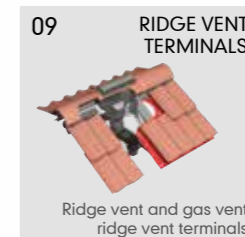
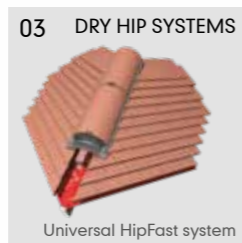



# BASE LAYERS

## UNDERLAYS & BATTENS

### FOR ROOF SYSTEMS

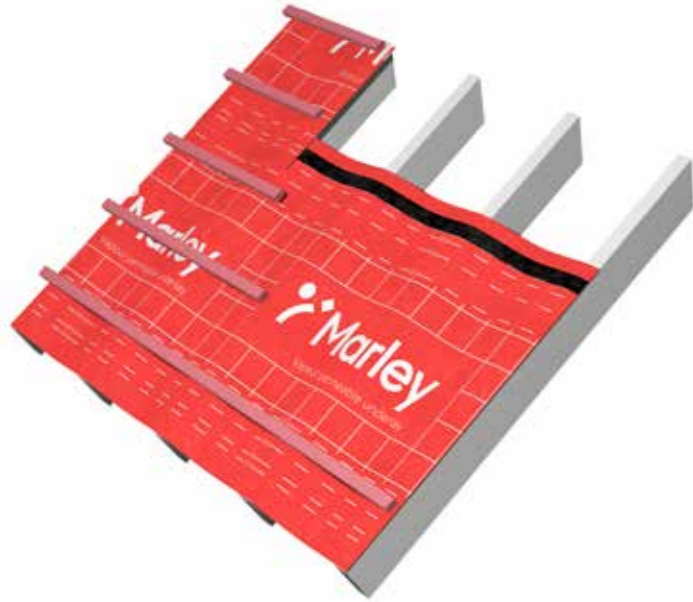

#### UNIVERSAL VAPOUR PERMEABLE UNDERLAY

Universal vapour permeable underlay is a lightweight, high performance breathable membrane for pitched roofs. Supplied in 1m x 50m rolls with integrated tape for sealing laps, the underlay is fully compliant to BS 5534 and suitable for all UK wind zones 1-5.

Universal vapour permeable underlay is designed to integrate seamlessly within a full Marley roof system and provides an additional means of ventilation to meet the requirements of BS 5250\*.

\* Consideration must be given to the type of roof covering used, which will influence the ventilation requirements. For further info, please contact the Marley technical department.

#### BENEFITS

- ▲ Vapour permeable
- ▲ High tensile and tear strength
- ▲ Clean and easy to handle
- ▲ Durable
- ▲ UV resistant
- ▲ BBA approved – Certificate No. 16/5335
- ▲ Integrated tape for sealing laps
- ▲ Guidance lines for minimum laps
- ▲ Suitable for vertical applications

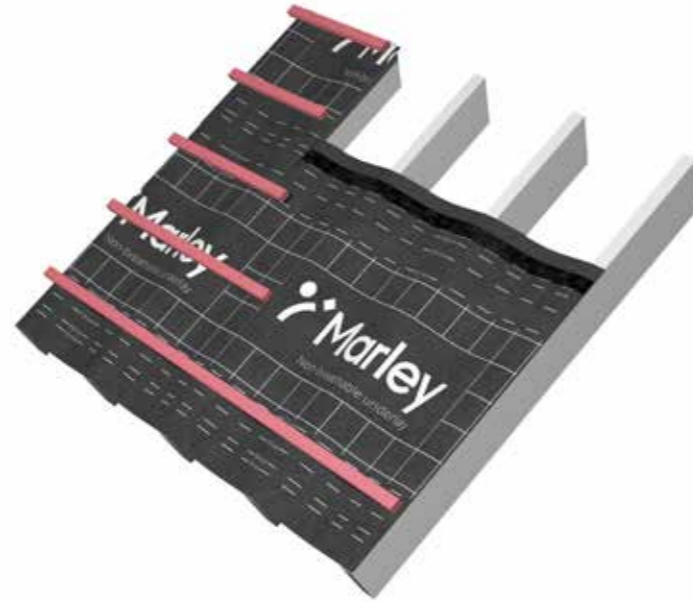

#### UNIVERSAL NON-BREATHABLE UNDERLAY

Universal non-breathable underlay is a lightweight, high performance membrane for pitched roofs. Supplied in 1m x 45m rolls with integrated tape for sealing laps, the underlay is fully compliant to BS 5534 and suitable for all UK wind zones 1-5.

Universal non-breathable underlay is designed to integrate seamlessly within a full Marley roof system and is suitable for roofs with traditional ventilation products or ventilated batten cavities.

#### BENEFITS

- ▲ Non-breathable
- ▲ High tensile and tear strength
- ▲ Clean and easy to handle
- ▲ Durable
- ▲ UV resistant
- ▲ BBA approved – Certificate No. 16/5334
- ▲ Lightweight alternative to traditional IF
- ▲ Integrated tape for sealing laps
- ▲ Guidance lines for minimum laps

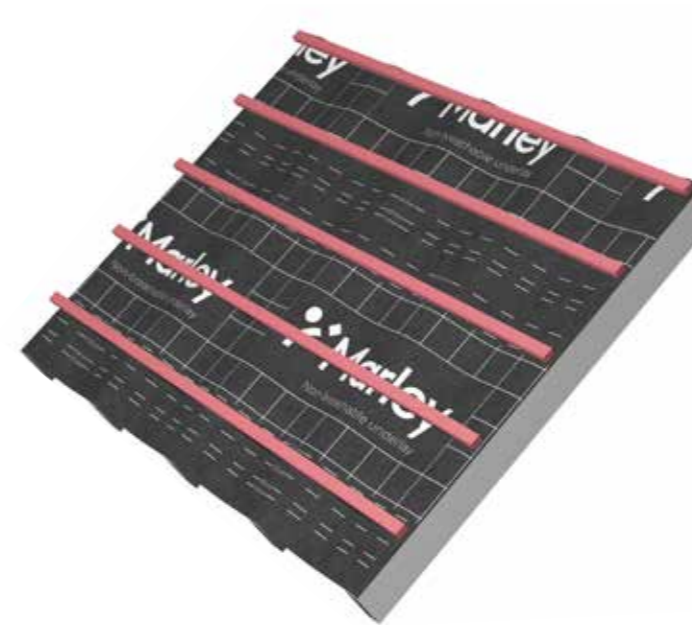

#### JB RED

JB Red is a high quality roofing batten and the first fully pre-graded batten available to the roofing industry.

JB Red completely meets the NHBC requirements for fully graded roofing battens. Its RED colour means that it is highly visible on site, therefore Local Authority Building Control, NHBC and other inspectors can see that high quality, pre-graded and compliant battens have been used.

All JB Red has full chain of custody (FSC or PEFC) certification and is available in both 25 x 38mm and 25 x 50mm sizes.

#### BENEFITS

- ▲ Pre-graded to all the strength requirements of BS 5534 for roofing battens.
- ▲ Marked according to BS 5534 showing supplier name, origin/species, grade (BS 5534) and size.
- ▲ The product and process is UKAS third party assessed by the BBA with a BBA Agrément certificate.



▲ JB Red is LABC registered detail and is approved for use by local authorities.

▲ JB Red carries full product liability insurance.

▲ Manufactured from slow grown, high grade timber, selected from the approved species within.

▲ BS 5534, typically European Redwood (PNSY) or European Whitewood (WPCA).

▲ Only kiln dried sideboards are used to ensure stability and dimensional accuracy.

▲ Treated to BS 8417 Usage Class 2, using Koppers MicroPro® with a unique Red Colour.

▲ Carries 60 year lifetime guarantee against insect attack and wood rotting fungi (when installed correctly in accordance with the requirements of Usage Class 2).

▲ Packaged in easy to handle bundles of 10.

#### BATTEN END CLIPS

These are for use with all dry verge units. Easily fitted to the batten end, they provide easy, fast and positive fixing of dry verge units to the batten end. Compliant with BS 8612.



# FITTINGS & ACCESSORIES FOR CLAY PLAIN TILES

Marley manufacture a wide range of clay plain tile fittings, decorative ridges and finials. All products can be installed in line with the latest BS 5534 'Code of Practice for Slating and Tiling' and NHBC Technical Standards.

Important note: All the fittings shown on these pages can be used with clay plain tiles, but should not be used on rafter pitches below 35° with Acme double camber or Ashdowne handcrafted clay plain tiles.

## PLAIN TILE FITTINGS

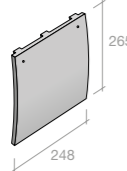
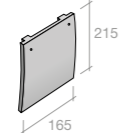
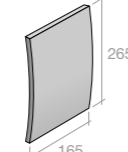
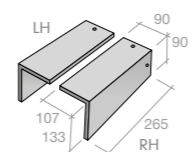
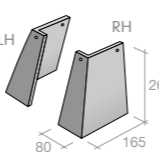
					
Description	Tile-and-a-half	Eaves/top tile	Creasing tiles§	Cloaked verge tiles*	external angle tiles
Angles available	n/a	n/a	n/a	n/a	90°, 135°

## RIDGE TILES

Mortar bedded security ridge kits are available (see page 59)

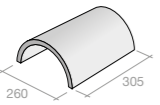
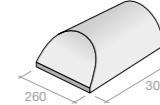
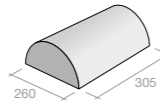
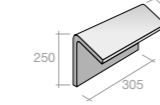
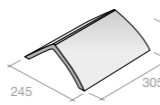
					
Description	Half round ridge	Half round ridge hip end*	Half round ridge stop end*	Mono ridge*	Hogs back ridge**
Angles available	n/a	n/a	130°, 135°, 145°	130°, 135°, 140°, 145°, 150°	n/a
Colours available	All colours	All colours	All colours	All colours	Burnished
Pitch range	30-50°	30-50°	30-50°	30-45°	30-45°

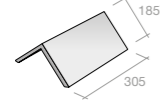
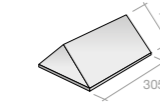
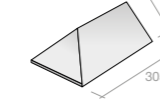
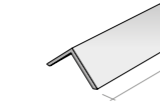
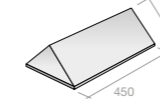
					
Description	305mm Angular ridge**	305mm Angular ridge stop end*	305mm Angular ridge hip end*	450mm Angular ridge	450mm Angular ridge stop end*
Angles available	90°, 105°	90°, 105°	90°, 105°	75°, 90°, 105°, 115°, 125°, 135°	75°, 90°, 105°, 115°, 125°, 135°
Colours available	All colours	All colours	All colours	Red Smooth, Slate Black	Red Smooth, Slate Black
Pitch range	See Tables 1, 3, 4, 5 & 6	See Tables 1, 3, 4, 5 & 6	See Tables 1, 3, 4, 5 & 6	See Tables 1, 3, 4, 5 & 6	See Tables 1, 3, 4, 5 & 6

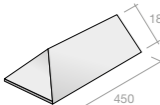
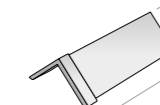
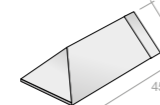
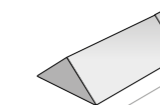
				
Description	450mm Angular ridge hip end*	450mm Capped angular ridge	450mm Capped angular ridge hip end	450mm Capped angular ridge stop end
Angles available	75°, 90°, 105°, 115°, 125°, 135°	75°, 90°, 105°, 115°, 125°, 135°	75°, 90°, 105°, 115°, 125°, 135°	75°, 90°, 105°, 115°, 125°, 135°
Colours available	Red Smooth, Slate Black	Red Smooth, Slate Black, Staffordshire Blue‡	Red Smooth, Slate Black, Staffordshire Blue‡	Red Smooth, Slate Black, Staffordshire Blue‡
Pitch range	See Tables 1, 3, 4, 5 & 6	See Tables 1, 3, 4, 5 & 6	See Tables 1, 3, 4, 5 & 6	See Tables 1, 3, 4, 5 & 6

## FEATURE TILES

Available in a range of colours, please contact customer services for more information.

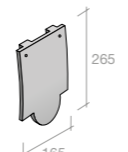
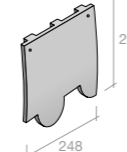
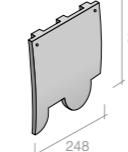
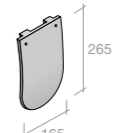
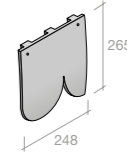
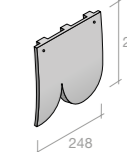
						
Description	Club feature tile*	RH club tile-and-a-half*	LH club tile-and-a-half*	Bullnose feature tile*	RH bullnose tile-and-a-half*	LH bullnose tile-and-a-half*

## HIPS AND VALLEYS

Mortar bedded security hip kits are available for third round ridges (see page 59)

						
Description	Granny hip	Semi bonnet hip	Arris hip**	Valley**	Third round hip**	Third round hip end**
Angles available	n/a	n/a	130°, 135°, 145°	130°, 135°, 140°, 145°, 150°	n/a	n/a
Pitch range	40-60°	30-40°	30-45°	30-50°	30-45°	30-45°

TABLE 1

Relationship of roof pitch to internal angle of hip

Known roof pitch	internal angles of hip tile	
	Plain tile roof	Slate roof
20-25°	-	135°
30°	145°	135°
35°	145°	125°
37.5°	140°	125°
40°	135°	115°
42.5°	135°	115°
45°	130°	115°
47.5°	127°	115°
50°	125°	105°
52.5°	120°	-
55°	120°	-
57.5°	115°	-
60°	115°	-

TABLE 2

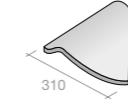
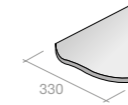
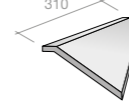
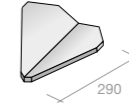
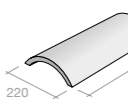
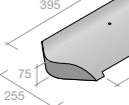
Relationship of roof pitch to valley angle

Known roof pitch	internal angles of hip tile	
	Plain tile roof	
30°	150°	
35°	150°	
37.5°	145°	
40°	140°	
42.5°	140°	
45°	135°	
50°	130°	

TABLE 3

Relationship of plain tile roof pitch to internal angle of ridge tiles

Known roof pitch	internal angles of ridge tile	
	Plain tile roof	
30°	115°	
35°	105°	
37.5°	105°	
40°	105°	
42.5°	90°	
45°	90°	
47.5°	90°	
50°	90°	
52.5°	-	
55°	75°	
57.5°	75°	
60°	75°	

TABLE 4

Relationship of slate roof pitch to internal angle of ridge tiles

Known roof pitch	internal angles of ridge tile	
	Slate roof	
20-25°	125°	
30°	115°	
35°	105°	
37.5°	90°	
40°	90°	
42.5°	75°	
45°	75°	
47.5°	75°	
50°	75°	

TABLE 5

Relationship of internal angle of ridge tiles to roof (plain tiles)

Known internal angle of ridge tile	Plain tile roof pitch
75°	52.5-60°
90°	42.5-52.5°
105°	30-42.5°

TABLE 6

Relationship of internal angle of ridge tiles to roof (slates)

Known internal angle of ridge tile	Slate roof pitch
75°	45-50°
90°	35-45°
105°	35°
115°	30°
125°	20-30°

\* Made to order (subject to minimum order quantities)

\*\* Some colours and angles made to order (subject to minimum order quantities)

‡ Staffordshire Blue available to order

† Angle ridge wing length will vary depending on ridge angle

§ Available in Red Smooth



# FITTINGS & ACCESSORIES FOR CLAY PLAIN TILES

Marley manufacture a wide range of clay plain tile fittings, decorative ridges and finials. All products can be installed in line with the latest BS 5534 'Code of Practice for Slating and Tiling' and NHBC Technical Standards.

Important note: All the fittings shown on these pages can be used with clay plain tiles, but should not be used on rafter pitches below 35° with Acme double camber or Ashdowne handcrafted clay plain tiles.

## DECORATIVE RIDGES

Mortar bedded security ridge kits are available (see page 59)

Description	Club crested ridge	Cocks comb crested ridge	Two hole crested ridge	Scroll finial (half round base)	Scroll finial* (plain angle base)
Angles available	90°, 105°	90°, 105°	90°, 105°	n/a	75°, 90°, 105°, 115°, 125°, 135°
Colours available	Red Smooth	Red Smooth	Red Smooth	Red Smooth, Slate Black	Red Smooth, Slate Black
Pitch range	See Tables 1, 3, 4, 5 & 6 (page 57)	See Tables 1, 3, 4, 5 & 6 (page 57)	See Tables 1, 3, 4, 5 & 6 (page 57)	30-50°	See Tables 1, 3, 4, 5 & 6 (page 57)

## FINIALS

Mortar bedded security ridge kits are available (see page 59)

Description	Ball top finial* (half round base)	Ball top finial* (plain angle base)	Fleur-de-Lys gable* (half round base)	Fleur-de-Lys gable* (plain angle base)	Extension piece (for Ball top / Fleur-de-Lys)
Angles available	n/a	75°, 90°, 105°, 115°, 125°, 135°	n/a	75°, 90°, 105°, 115°, 125°, 135°	n/a
Colours available	Red Smooth, Slate Black	Red Smooth, Slate Black	Red Smooth, Slate Black	Red Smooth, Slate Black	Red Smooth, Slate Black
Pitch range	30-50°	See Tables 1, 3, 4, 5 & 6 (page 57)	30-50°	See Tables 1, 3, 4, 5 & 6 (page 57)	n/a

\* Made to order (subject to minimum order quantities)

\*\* Some colours and angles made to order (subject to minimum order quantities)

† Angle ridge wing length will vary depending on ridge angle

## SERVICES

Marley offer a full range of technical and online advice services, including NBS and fixing specifications, which will help you meet the requirements of BS 5534.

▲ Fixing specifications [marley.co.uk/tilefix](http://marley.co.uk/tilefix)

▲ NBS clauses [marley.co.uk/specrite](http://marley.co.uk/specrite)

## MORTAR BEDDED SECURITY FIXING

Under BS 5534, the use of mortar as a sole means of fixing roof tiles and fittings is insufficient. Not only should careful consideration be given to the creation of a suitable roof mortar through the correct sand and cement mix, but tiles or fittings bedded with this mortar must also be accompanied by a mechanical fix.



### MORTAR BEDDED SECURITY HIP

Mechanical fixing system for mortar bedded ridge hip, helping house builders and contractors meet British Standards and NHBC guidelines.

Watch a quick video on mortar bedded mechanical fixing at [marley.co.uk/securityhip](http://marley.co.uk/securityhip) or scan the QR code shown

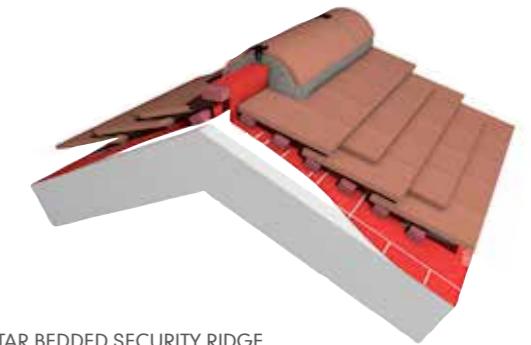

### MORTAR BEDDED SECURITY RIDGE

Mechanical fixing system for mortar bedded ridge ridges, helping house builders and contractors meet British Standards and NHBC guidelines.

Watch a quick video on mortar bedded mechanical fixing at [marley.co.uk/securityridge](http://marley.co.uk/securityridge) or scan the QR code shown

## DRY FIX SOLUTIONS

Avoiding mortar with its associated risks and maintenance will always be best practice, and the changes to BS 5534 should assist in the continued adoption of dry fix.

For a mortar and maintenance free mechanical fix, Marley also offers a range of high performance dry fix solutions, including ridge and hip systems that are able to contribute towards ventilation to meet the requirements of BS 5250.



### MORE ABOUT OUR DRY FIX SYSTEMS

Our website contains further information about dry fix and ventilation solutions, including the Universal range, which not only works with our roof tiles but those of other manufacturers too: [www.marley.co.uk/dryfix](http://www.marley.co.uk/dryfix)



# PROPERTIES & PERFORMANCE

## ANATOMY OF SINGLE CAMBER CLAY PLAIN TILE

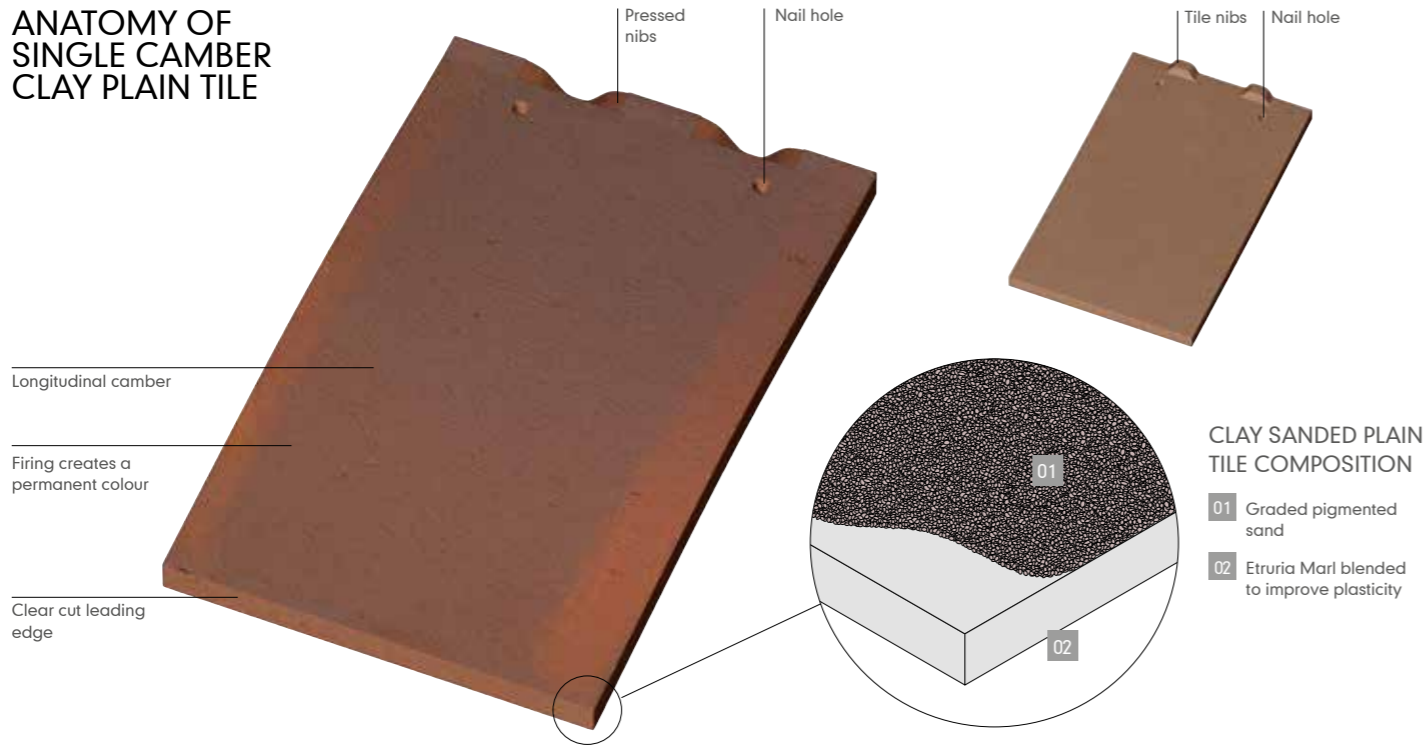

## FEATURES OF CLAY PLAIN TILES

- ▲ Low pitch options down to 30°
- ▲ BES 6001 Certified 'Excellent'
- ▲ Can achieve A+ in the BRE Green Guide
- ▲ Suitable for roofing or vertical tiling
- ▲ 100% recyclable

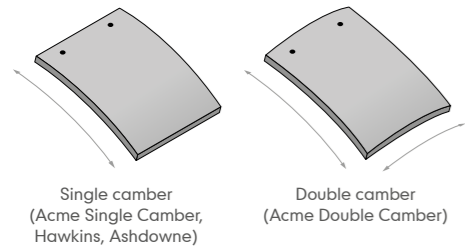

## AUTHORITY

Marley clay roof tiles are manufactured to BS EN 1304 'Clay roofing tiles for discontinuous laying – Product definitions and specifications', operating a quality management system meeting the requirements of BS EN ISO 9001 'Quality Management Systems – requirements'.

Additionally, the manufacturing plant operates an environmental management system, in line with BS EN ISO 14001 'Environmental management systems – Specification with guidance for use' and Health and Safety Standard OHSAS 18001, working towards BS EN ISO 45001 certification.

Marley clay plain tiles are UKCA and CE marked in line with the Construction Product Regulation ([marley.co.uk/ce](http://marley.co.uk/ce)). They are also rated 'Excellent' in the BES 6001 Framework Standard for the Responsible Sourcing of Construction Products.

## CARBON FOOTPRINTING

Clay plain tiles can have a carbon footprint figure as low as 27 CO<sub>2</sub>e/m<sup>2</sup>.

## RECYCLABILITY

At end of life, clay plain tiles can be reused or crushed and used as aggregate without the need for further processing. As a natural product, no special disposal considerations are required.

## COMPOSITION AND MANUFACTURE

All Marley clay plain tiles are manufactured from high quality Staffordshire Etruria Marl, generally accepted as the finest clay for strength and durability.

Clays are carefully blended to improve plasticity and strength. The tiles are machine or hand moulded, dried and fired in gas fired tunnel kilns, using an advanced computer controlled system. This ensures that the products are made to exact tolerances in shape, size, colour and strength.

## PERFORMANCE

Marley clay plain tiles are tested for resistance to wind driven rain and meet the requirements of BS 5534 'Code of practice for slating and tiling (including shingles)' with respect to wind loading, when fixed in accordance with our recommendations.

## STRENGTH AND DURABILITY

Marley clay plain tiles are also extremely strong, with a transverse strength well in excess of the 600N minimum requirement in BS EN 1304.

## FIRE RESISTANCE

Marley clay plain tiles are non-combustible and meet the requirements for external fire performance without the need for further testing in accordance with Class B roof of BS EN 13501-5 using data from external exposure to fire roof tests (BS 476-3) as defined in ENV 1187. There are no restrictions on their use under the Building Regulations and are designated AA in Table A5 of Appendix A, Approved Document B, 'Fire Safety'.

## ENVIRONMENTAL EFFECTS

### THERMAL

Unaffected by extremes of temperature. Tiles should be laid with a slight gap (1-3mm) to accommodate any movement induced by changes in temperature.

The thermal resistance (R) of Marley clay tiles when dry is 0.013m<sup>2</sup>K/W.

For the purpose of thermal transmittance calculations, the preceding 'R' values should be substituted by a figure of 0.12m<sup>2</sup>K/W which includes the roof covering and the airspace behind the tiles or slates. An 'R' value of 0.020m<sup>2</sup>K/W should be added for the roof underlay.

### FROST

Unaffected by frost, and meets the requirements of BS EN 1304 Annex A when tested to EN 539-2 in accordance with national requirements.

### SUNLIGHT

Clay tiles do not fade and are unaffected by prolonged exposure to UV and sunlight.

### ATMOSPHERIC POLLUTION

Suitable for all rural, marine and normal industrial environments. Avoid discharge of gases or liquids from chemical processes onto the surface of the tiles. Resistant to all but the most highly polluted atmospheres, where sulphur dioxide levels exceed 70 micrograms/m<sup>3</sup> of air.

### ELECTRICITY

Marley clay tiles are electronically insulating. Reference should be made to BS 6651 for recommendations on the protection of buildings against lightning strikes.

## BIOLOGICAL EFFECTS

### BIRDS AND RODENTS

Not affected or degraded by birds, rodents or insects.

### MOSSES AND LICHENS

Water absorption of Marley clay plain tiles is very low, making their surface less likely to support growth of mosses and lichens, unless promoted by local environmental factors such as overhanging trees. Removal may only be required if growth is sufficient to restrict the drainage of water from the roof.

## HEALTH AND SAFETY

When cutting tiles using an angle grinder, measures to reduce the effect of dust should be taken in accordance with the HSE Guidance Note EH 40 'Occupational Exposure Limits', EH 44 'Dust in the workplace: general principles of protection' and HSE Guidance Note EH59/2 (Respiratory Crystalline Silica). For a copy of the Marley clay tiles COSHH datasheet, visit [marley.co.uk/about/HealthandSafety](http://marley.co.uk/about/HealthandSafety)

## APPEARANCE

To avoid the risk of colour patching and bands of different shades, tiles should be randomly selected from at least three separate pallets from the same production batch. Ensure there are sufficient quantities of mixed tiles to complete each roof elevation.

## FIXING SPECIFICATION

Tiles should be fixed in accordance with the recommendations of BS 5534. The Marley Technical Advisory Service can provide a fixing specification applicable for every roof design, given the relevant criteria relating to type of roof tile, site location, topography, and building/roof dimensions. Fixing specifications can also be completed online at [marley.co.uk/tilefix](http://marley.co.uk/tilefix)



## DESIGN DETAILS

### EAVES

#### UNIVERSAL EAVES VENT SYSTEM

- ▲ eaves ventilation to satisfy 10mm or 25mm conditions
- ▲ continuous rafter roll compresses insulation to allow free air passage (use two rolls to compress deep insulation)
- ▲ strip ventilator has discreet ventilation grille and is nailed to fascia or timber fillet
- ▲ suitable with or without soffit board
- ▲ mechanically fix all tiles at eaves

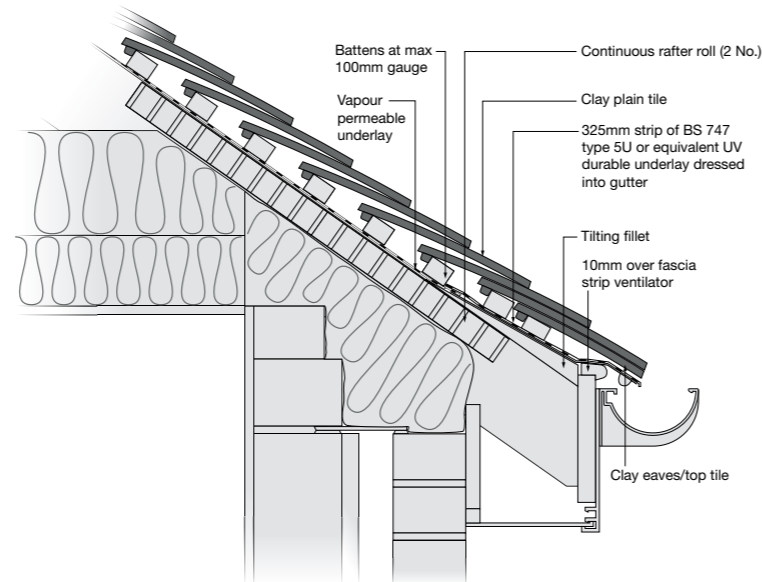

#### UNIVERSAL 10MM EAVES VENTILATION

- ▲ cold roof with vapour permeable underlay shown

## DESIGN DETAILS

### VERGES

#### PLAIN TILE CLOAK VERGE

- ▲ maximum pitch for duo-pitch and mono-pitch roofs is 55° (mitre top cloak verge tiles if required)
- ▲ not suitable for raking verges
- ▲ finish tiling battens flush with edge of bargeboard or brickwork
- ▲ complete verge using cloaked verge tiles
- ▲ fix all tiles with 2 No. 38mm x 2.65mm aluminium nails
- ▲ at apex of roof/verge fit block end ridge tile

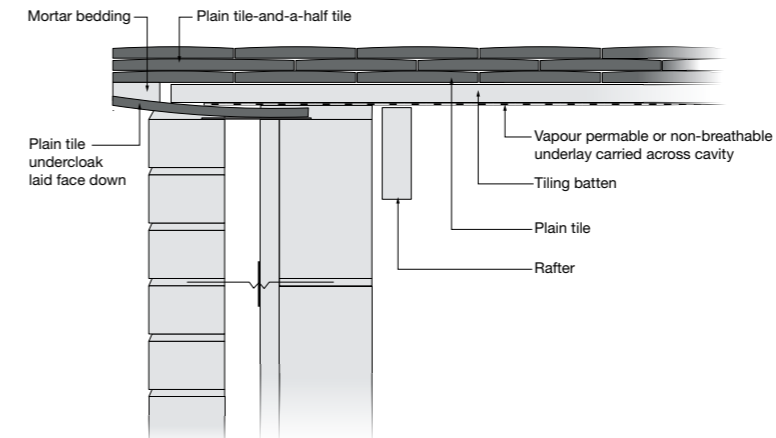

#### BEDDED VERGE

- ▲ form using tile and tile-and-a-half tiles in alternate courses
- ▲ use undercloak of either fibre cement laid with slope away from outer wall or plain tiles laid face down and overhanging wall
- ▲ verge overhang to be 38mm-50mm
- ▲ fully nail all tiles at verge where possible
- ▲ mortar bedding to comply with tensile board strength in BS 5534

#### TECHNICAL TOOLKIT

Marley provides a comprehensive technical service and a range of online tools to ensure design performance and compliance to the latest Building Regulations and NHBC Technical Standards. These services include:

- ▲ Fixing specifications [marley.co.uk/tilefix](http://marley.co.uk/tilefix)
- ▲ NBS clauses [marley.co.uk/specrite](http://marley.co.uk/specrite)
- ▲ CAD details [marley.co.uk/cad](http://marley.co.uk/cad)
- ▲ BIM models [marley.co.uk/bim](http://marley.co.uk/bim)



# DESIGN DETAILS

## HIPS

### ARRIS HIP

- ▲ maximum rafter pitch 45°
- ▲ use on hips with plan angle of 90° and equal pitches on adjacent roof slopes
- ▲ fix to hip batten using 65mm x 3.35mm aluminium nail
- ▲ bed top of tiles with 3:1 sand/cement mortar to BS 5534
- ▲ complete hip at ridge or top abutment with lead saddle

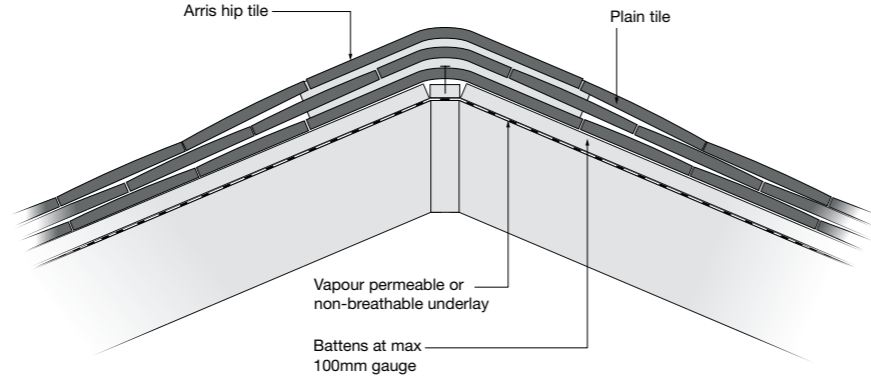

### GRANNY BONNET HIP

- ▲ maximum rafter pitch 60°
- ▲ use on hips with plan angle of 90° and equal pitches on adjacent roof slopes
- ▲ fix to hip batten using 70mm x 3.35mm aluminium nail
- ▲ bed and point with 3:1 sand/cement mortar to BS 5534
- ▲ complete hip at ridge or top abutment with lead saddle

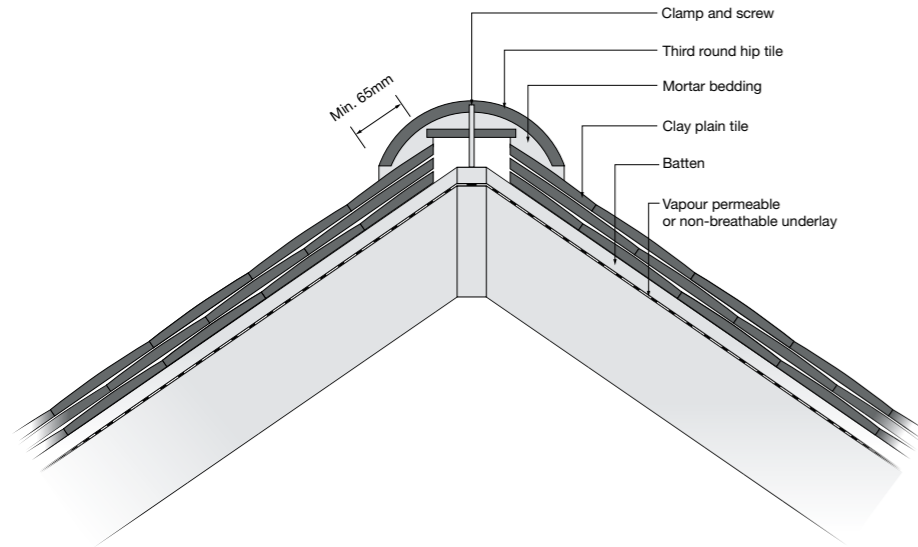
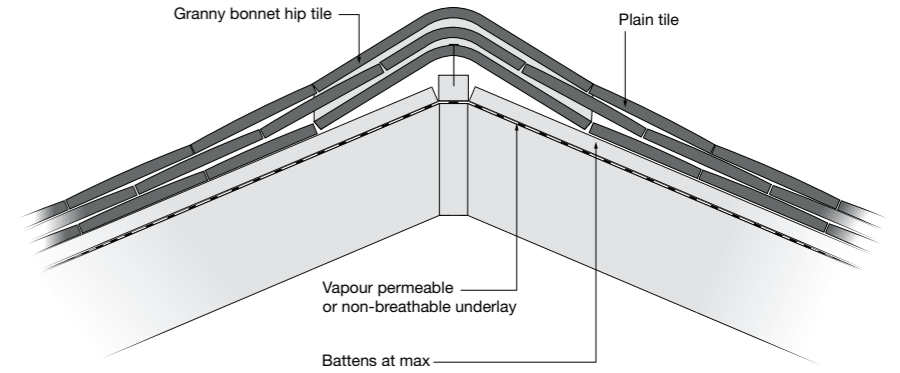

### MORTAR BEDDED SECURITY HIP (MECHANICAL FIXING)

- ▲ fix galvanised hip iron at base of hip
- ▲ edge bed hip tiles onto close mitred tiles with 3:1 sand/cement mortar
- ▲ mechanically fix in line with BS 5534. Security ridge packs are available for half round and third round ridges (Code 43605)
- ▲ complete hip at ridge apex with three way mitre or half round ridge hip end

Watch a quick video on mortar bedded mechanical fixing at [marley.co.uk/securityhip](http://marley.co.uk/securityhip)

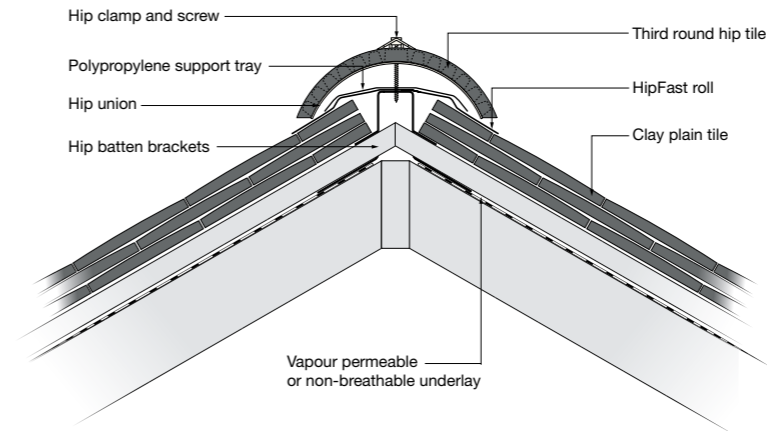

### UNIVERSAL HIPFAST DRY HIP SYSTEM

Provides additional ventilation to the roof void when a 5mm gap is provided in the underlay and is used in conjunction with either eaves or ridge ventilation systems, or vent tiles.

- ▲ maximum rafter pitch 60°
- ▲ provides additional ventilation to the roof void when a 5mm gap in the underlay is used in conjunction with either eaves or ridge ventilated systems or ventilation tiles
- ▲ use one or two thicknesses of 50mm x 25mm batten to fit batten brackets
- ▲ use block end hip tile at eaves
- ▲ mechanically fixes each hip tile via hip unions and clamps
- ▲ complete hip at ridge with lead soaker/saddle

### TECHNICAL TOOLKIT

Marley provides a comprehensive technical service and a range of online tools to ensure design performance and compliance to the latest Building Regulations and NHBC Technical Standards. These services include:

- ▲ Fixing specifications [marley.co.uk/tilefix](http://marley.co.uk/tilefix)
- ▲ NBS clauses [marley.co.uk/specrite](http://marley.co.uk/specrite)
- ▲ CAD details [marley.co.uk/cad](http://marley.co.uk/cad)
- ▲ BIM models [marley.co.uk/bim](http://marley.co.uk/bim)



## DESIGN DETAILS VALLEYS

### GRP DRY VALLEY

- ▲ maximum valley length 8m
- ▲ suitable for all plan angles and where the pitch either side of the valley varies by a maximum of 20°
- ▲ provides continuous support for valley trough using 19mm timber ply boards inset between rafters or 6mm continuous ply boards laid over rafters
- ▲ tightly butt tiles or slates to central upstand of valley units to prevent ingress of birds or vermin
- ▲ provide metal apron at foot of valley and dress into gutter at eaves. For rafter pitches below 25° cut fascia board to maintain valley pitch
- ▲ nail or clip adjacent tiles to the valley and avoid small cuts by using half tiles as penultimate tile to valley. Fix smaller cut tiles with secret cut tile clips
- ▲ complete top of valley with a lead saddle

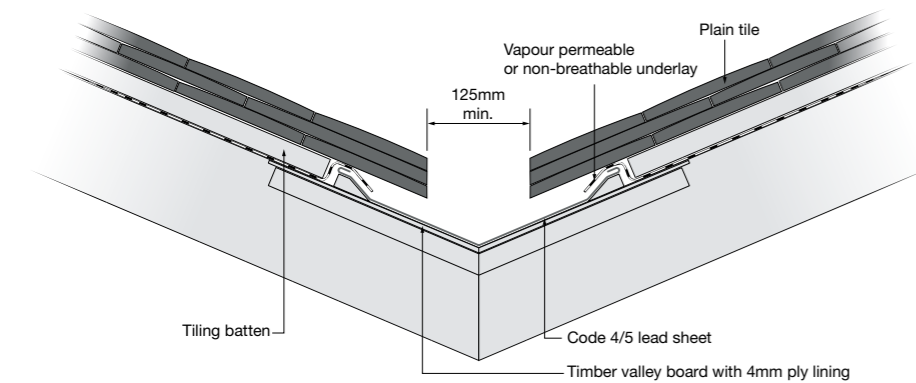

### SHEET METAL VALLEY

- ▲ minimum rafter pitch 35°
- ▲ suitable for all plan angles and where the pitch either side of the valley varies
- ▲ provide continuous support for metal valley lining using timber lay boards inset between rafters with 4mm ply lining board over
- ▲ form 125mm minimum gap between raking cut tiles
- ▲ carry metal lining into gutter at eaves
- ▲ use tile-and-a-half tiles to minimise small cut tiles
- ▲ nail all adjacent tiles to the valley
- ▲ complete top of valley with a lead saddle

## DESIGN DETAILS VALLEYS & ABUTMENT

### PURPOSE MADE VALLEY TILES

- Suitable for all clay plain tiles. Vapour permeable underlay shown.
- ▲ a range of valley tiles are available to suit 30-50° roof pitches
  - ▲ suitable for a plan angle of 90° only and equal pitches either side of the valley
  - ▲ provide continuous support for valley tile using timber lay boards of battens inset between rafters
  - ▲ use tile-and-a-half tiles adjacent to valley tile to avoid small cuts
  - ▲ complete top of valley with a lead saddle

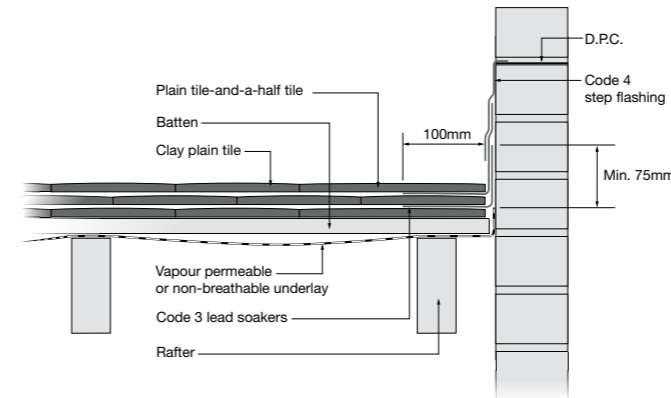
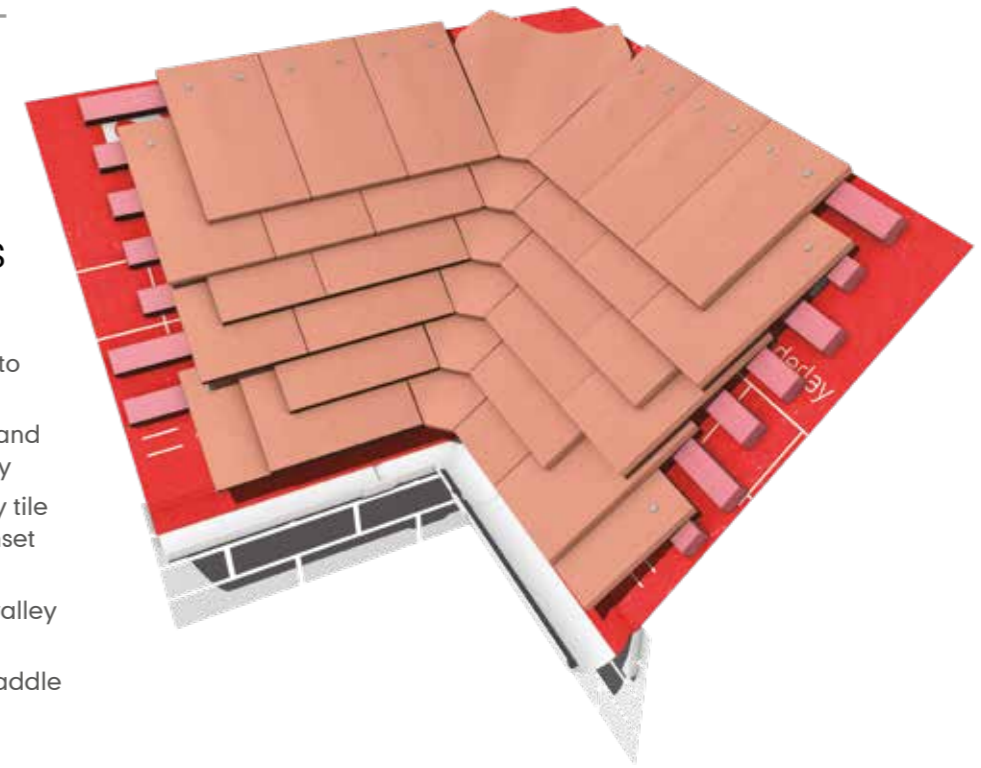

### SIDE ABUTMENT

- ▲ bring tiles as close to abutment as possible
- ▲ use Code 3 lead soakers or Marley GRP soakers and Code 4 lead cover flashing

### TECHNICAL TOOLKIT

Marley provides a comprehensive technical service and a range of online tools to ensure design performance and compliance to the latest Building Regulations and NHBC Technical Standards. These services include:

- ▲ Fixing specifications [marley.co.uk/tilefix](http://marley.co.uk/tilefix)
- ▲ NBS clauses [marley.co.uk/specrite](http://marley.co.uk/specrite)
- ▲ CAD details [marley.co.uk/cad](http://marley.co.uk/cad)
- ▲ BIM models [marley.co.uk/bim](http://marley.co.uk/bim)



## DESIGN DETAILS RIDGES

### UNIVERSAL RIDGEFAST DRY RIDGE SYSTEM

- ▲ maximum rafter pitch 60°
- ▲ provides 5,000mm<sup>2</sup>/m free vent area at ridge apex
- ▲ ensure gap is provided in roof underlay to vent roof void
- ▲ use one or two thicknesses of 50mm x 25mm batten to fit batten brackets
- ▲ mechanically fix all top course tiles
- ▲ use block end ridge tile at ridge end

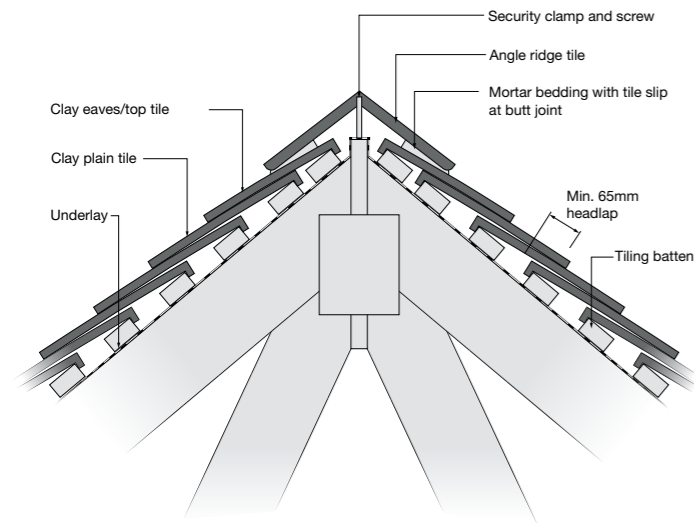
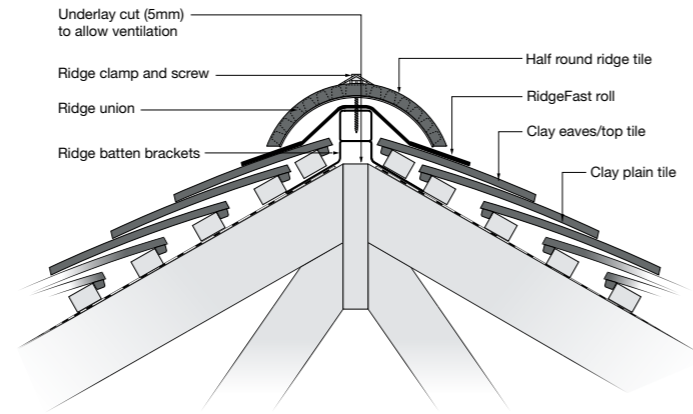

### MORTAR BEDDED SECURITY RIDGE (MECHANICAL FIXING)

- ▲ mechanically fix ridge tile in line with BS 5534 fixing guidelines
- ▲ security ridge packs are available for all angle, half round, third round, hog's back and decorative ridge tiles, except Roll Top ridges (Code 43605)

Watch a quick video on mortar bedded mechanical fixing at [marley.co.uk/securityridge](http://marley.co.uk/securityridge)

### TECHNICAL TOOLKIT

Marley provides a comprehensive technical service and a range of online tools to ensure design performance and compliance to the latest Building Regulations and NHBC Technical Standards. These services include:

- ▲ Fixing specifications [marley.co.uk/tilefix](http://marley.co.uk/tilefix)
- ▲ NBS clauses [marley.co.uk/specrite](http://marley.co.uk/specrite)
- ▲ CAD details [marley.co.uk/cad](http://marley.co.uk/cad)
- ▲ BIM models [marley.co.uk/bim](http://marley.co.uk/bim)

## DESIGN DETAILS ROOF SLOPES

### UNIVERSAL PLAIN TILE VENT TERMINAL

Vapour permeable underlay shown.

- ▲ locate clear of rafters
- ▲ use soaker tray to weather hole in underlay
- ▲ locate at 2.0m centres for 5,000mm<sup>2</sup>/lin.m ventilation and 1.0m centres for 10,000mm<sup>2</sup>/lin.m ventilation
- ▲ suitable for roof space ventilation, mechanical extract and soil vent pipe
- ▲ use flexible pipe for connection to 110mm dia. pipework as termination to mechanical extract or soil vent pipe
- ▲ do not use as exhaust for hot flue gases
- ▲ when used as extract for soil vent pipes, keep minimum 900mm above any opening into building within 3m of vent terminal

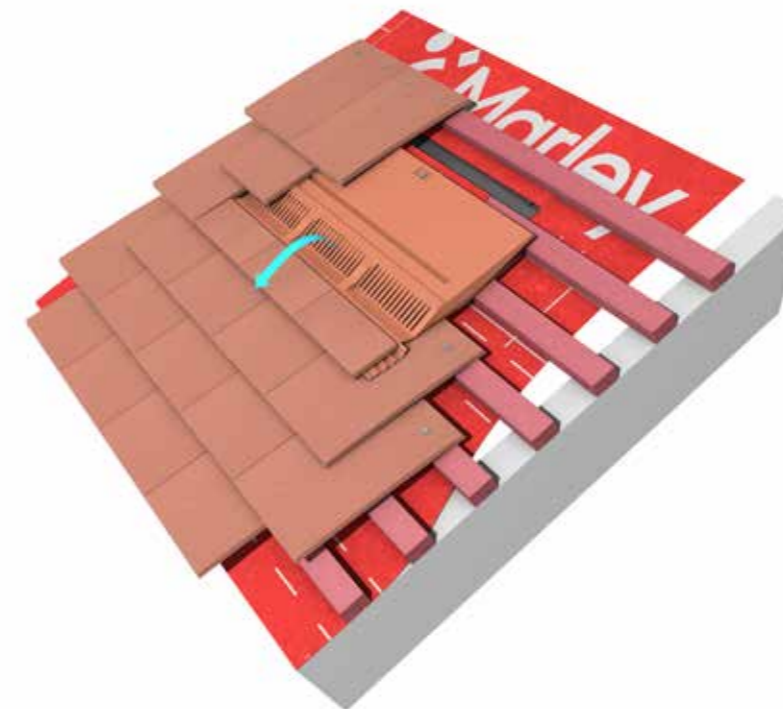
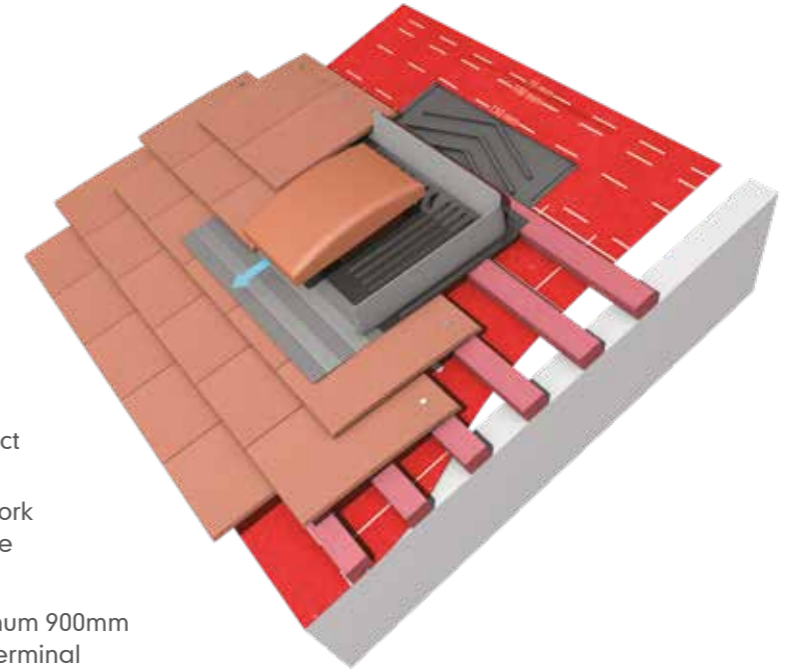

### IN-LINE CLAY TILE VENT TERMINAL

Vapour permeable underlay shown.

- ▲ locate clear of rafters
- ▲ use soaker tray to weather hole in underlay for spigot
- ▲ locate at 1.5m centres for 5,000mm<sup>2</sup>/lin.m ventilation and 0.75m centres for 10,000mm<sup>2</sup>/lin.m ventilation
- ▲ use tile vent adaptor and flexible pipe for connection to 110mm dia. pipework as termination to mechanical extract or soil vent pipe
- ▲ do not use as exhaust for hot flue gases
- ▲ when used as extract for soil vent pipes, keep minimum 900mm above any opening into building within 3m of vent terminal



## DESIGN DETAILS

### OTHER CONSTRUCTIONS

#### CHANGE OF PITCH

- ▲ provide timber layboard and fillet for lead flashing
- ▲ maintain continuous lap of underlay at junction of two pitches
- ▲ extend upper course of tiles over lead to conceal flashing
- ▲ allow minimum 150mm lap of flashing onto lower course of tiles

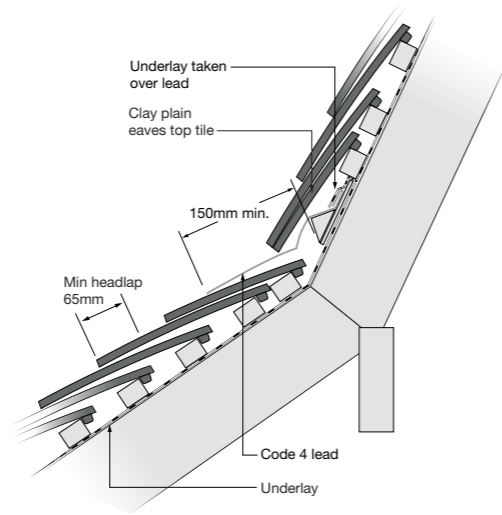

#### CURVED AND CONICAL ROOFS

Curved roofs can be designed with either horizontal or vertical curves, or a combination of both to form a dome. Double-lap clay plain tiles are the most suitable covering as they are relatively thin and are easily tapered to accommodate the radius of the roof. Designers should, however, be aware of the limitations of using tiles on curved roofs, as the shape and pitch may compromise their function as a weatherproof roof covering. In these circumstances, the tiles are decorative and a suitable weatherproof sub-roof should be provided.

Conical roofs can be formed as a complete circle on plan, as in the case of a turret or can also be segmental as in an apse end.

The following points should be considered when designing a curved or conical roof:

- ▲ maintain a steep roof pitch – 55° and above. (At pitches below this, extensive use of tile-and-a-half tiles may be required to maintain the necessary side laps below).
- ▲ consider the maximum and minimum radii of the curve – this will dictate the available taper in the tile and the side-lap that can be achieved. Plain tiles require a minimum side lap of 55mm (35-55° rafter pitch), and 45mm (56° rafter pitch and over) in moderate exposure.
- ▲ keep spacing of the rafters at 450mm or less.
- ▲ provide two or three layers of plywood (min. thickness 4.5mm) or softwood boards (min. thickness 15mm) with counter layers laid diagonally around radius of the roof as groundwork for battens or for direct nailing of tiles.

#### EYEBROW DORMERS

This form of curved roof using clay tiles has been derived from thatched roofs, where the thatch was swept over dormer windows providing daylight to the habitable roof void.

When designed for the application of clay tiles, they have the effect of parting the courses horizontally, but the final shape of the eyebrow is dictated by structural considerations and the ability of the design to be weathertight.

The following points should be noted when designing an eyebrow dormer:

- ▲ best formed in roofs of 55° pitch or above
- ▲ pitch of eyebrow should not be less than 35° in moderate exposure
- ▲ the transition curve of the eave should be as smooth as possible with the actual span of the total transition not more than 10 units for each unit of height of the window opening (measured from top tile below to the eaves tile at the centre of the eyebrow)
- ▲ the two central rafters should intersect with the roof slope a minimum of 1m down from the ridge
- ▲ use metal soakers with tiles on the eyebrow where the roof pitch is below 55°
- ▲ the bond of the tiles should be set out from the two sides towards the centre to give an increased side lap on the lower side
- ▲ provide special groundwork for the battens, which should be scarfed to fit the swept profile of the roof timbers
- ▲ allow at least 900mm of regular tiling to follow from the sweep of the eyebrow

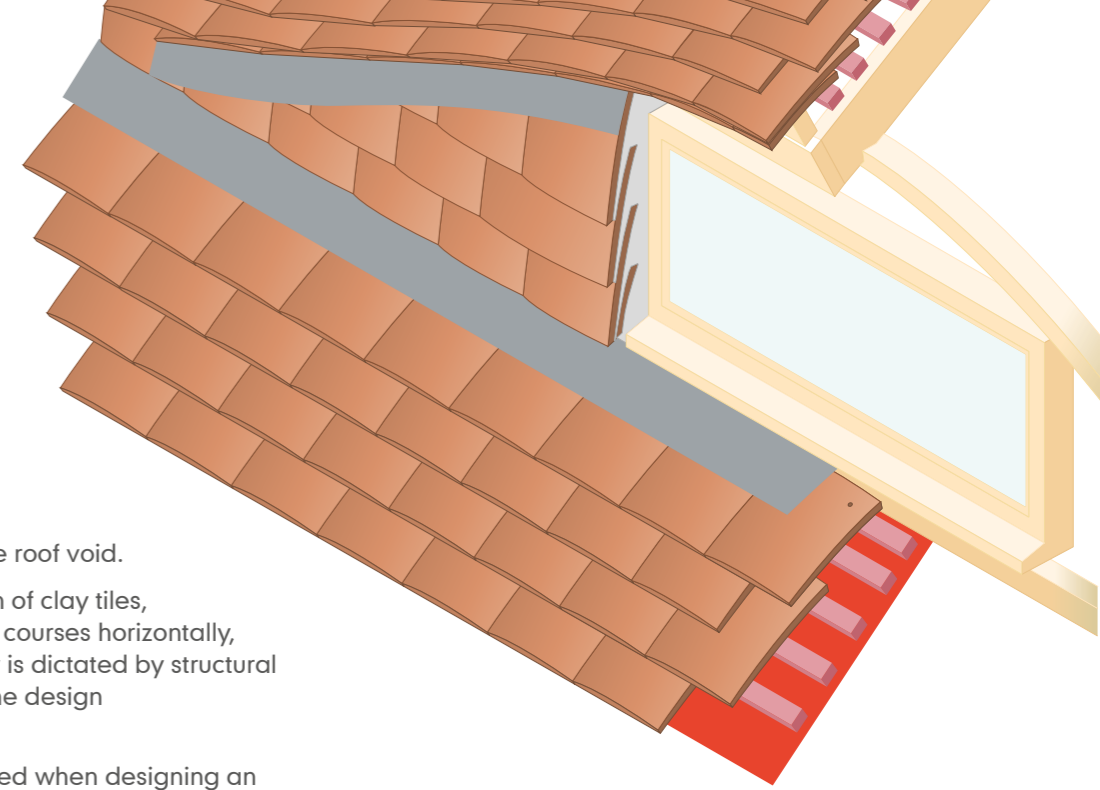

#### CREASING TILES

Creasing tiles are nibless clay plain tiles and can be used for cappings or copings to walls and sills. Their decorative and crisp lines can also be used in corbelling, arches, chimneys and decorative quoins and their weatherproof properties make them ideal for use in free-standing walls and parapets. Available in Red Smooth.

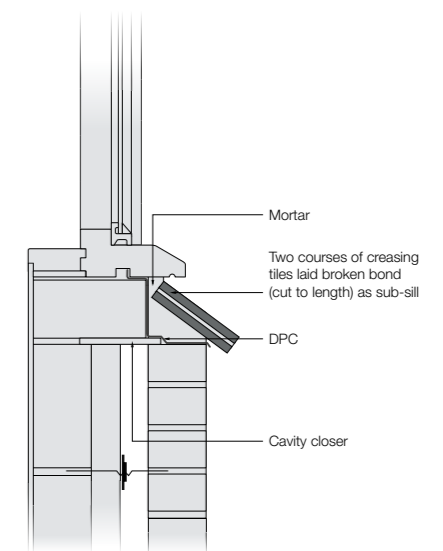



# DESIGN DETAILS

## OTHER CONSTRUCTIONS

### VERTICAL TILING

Clay plain tiling is an excellent weatherproof and attractive cladding to the vertical walls of any building. Feature and ornamental tiles may also be used with clay plain tiles to create decorative patterns.

- ▲ use counter battens over masonry construction (38mm x 25mm minimum) to reduce direct fixing. Special masonry fixings may be required
- ▲ ensure tiling details do not interfere with the opening of windows and doors
- ▲ lead flashings and soakers should be used around openings in accordance with Lead Sheet Association details
- ▲ use double course of tiles at eaves, by laying first course of eaves/tops tiles with course of full tiles over
- ▲ at top of wall or under a sill, use a course of eaves/tops tile laid over a course of full tiles. Dress a Code 4 lead cover flashing over by 100mm
- ▲ use internal and external angle tiles at all 90° corners. Purpose made 135° angle tiles are also available. For other angles, close mitre tiles and use Code 3 lead soakers
- ▲ all tiles should be twice nailed

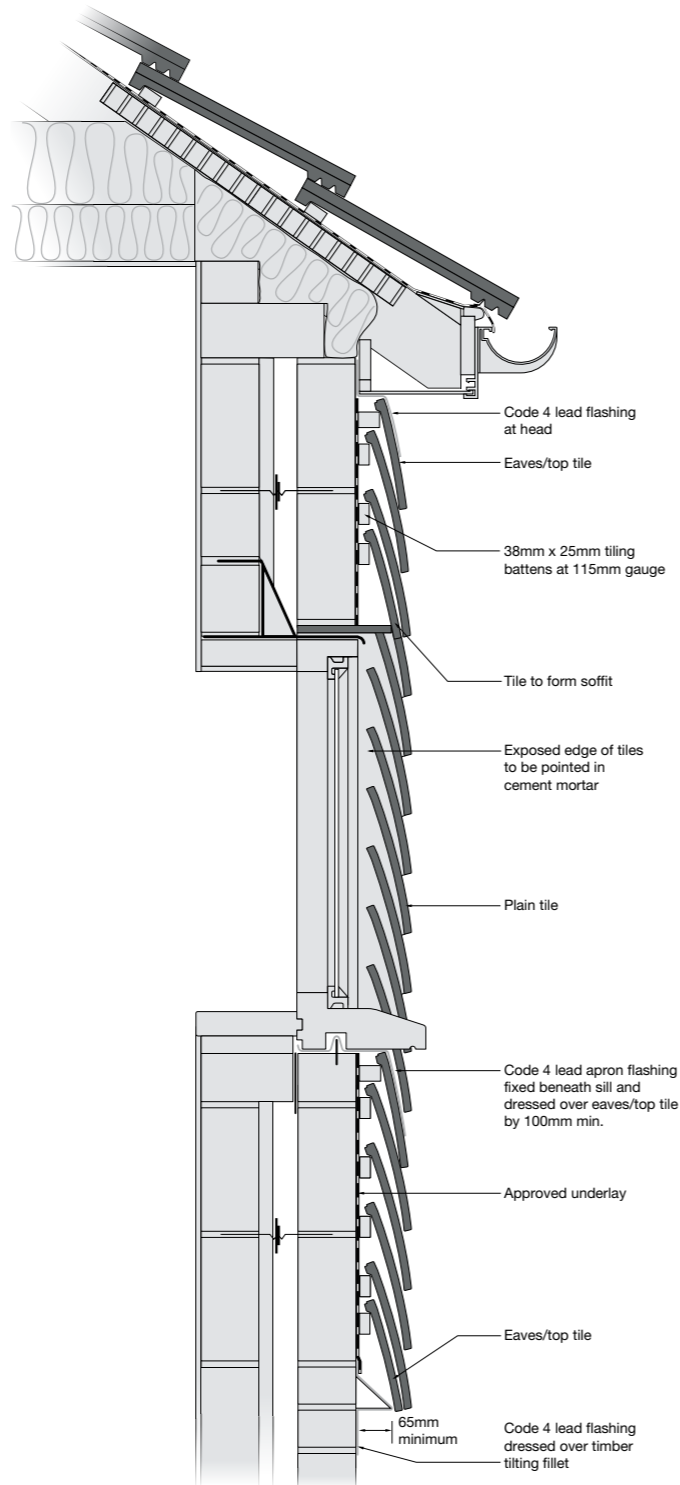

### 90° EXTERNAL ANGLE TILES

Vertical angle tiles are available in left and right handed formats to fit 90° and 135° angle external corners of wall elements and are designed to bond with standard plain tiles. The following guidance notes apply to this detail:

- ▲ counter battens, where used, should be fixed 20mm in from the end of the tiling battens at the corner, to prevent the end nail or screw fixing from splitting the tile batten
- ▲ cut ends of the tiling battens should be alternated to coincide with the short leg of the external angle tiles
- ▲ fix left and right handed external angle tiles in alternate courses up the external corner to fit with the adjacent standard plain tiles
- ▲ avoid cutting the angle tiles to fit with the adjacent tiles
- ▲ secure each vertical angle tile by twice nailing

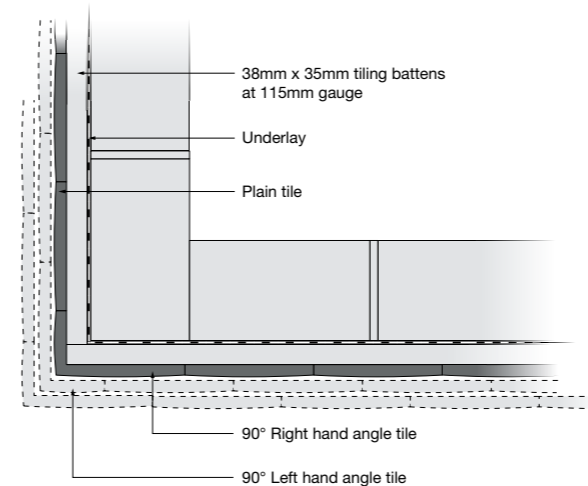

### WINCHESTER CUT

This gable end detail avoids the use of small triangular pieces of tile by providing a secure fixing of a tile-and-a-half against the rake of the gable.

- ▲ best suited for roof pitches of 40° and above
- ▲ fix batten parallel with rake of verge and level with vertical tiling battens
- ▲ use tile-and-a-half at end of each course and cut to rake (all tiles should be of uniform cut)
- ▲ cut adjacent tile to raking cut tile-and-a-half
- ▲ use Code 3 lead soakers (200mm x 200mm) where side laps are less than 55mm
- ▲ at apex use a tile-and-a-half turned through 45° and cut to shape

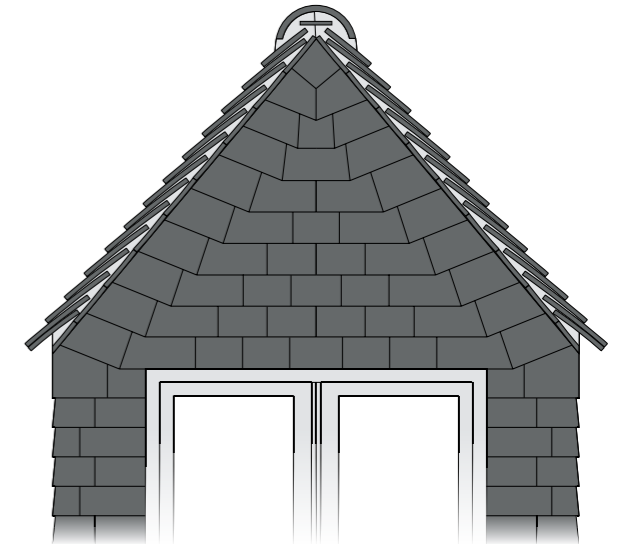

### TECHNICAL TOOLKIT

Marley provides a comprehensive technical service and a range of online tools to ensure design performance and compliance to the latest Building Regulations and NHBC Technical Standards. These services include:

- ▲ Fixing specifications [marley.co.uk/tilefix](http://marley.co.uk/tilefix)
- ▲ NBS clauses [marley.co.uk/specrite](http://marley.co.uk/specrite)
- ▲ CAD details [marley.co.uk/cad](http://marley.co.uk/cad)
- ▲ BIM models [marley.co.uk/bim](http://marley.co.uk/bim)





# Here to help

Getting our knowledge to you and your project smoothly and efficiently

## ▲ CUSTOMER SERVICES

Marley is committed to providing outstanding customer care and is staffed by experienced personnel: Tel 01283 722588 or e-mail [info@marley.co.uk](mailto:info@marley.co.uk)

To find your nearest stockist, please visit: [marley.co.uk/stockists](http://marley.co.uk/stockists)

## ▲ TECHNICAL ADVISORY SERVICE

Specifiers require prompt, knowledgeable and detailed responses to a vast range of enquiries covering everything from the embodied energy of a typical roof tile, to the different ventilation options available.

Our Technical Advisory Service is staffed by a qualified team with specialist knowledge not only of all Marley products, but also crucially, how those systems integrate with other roofing components and comply with Building Regulations, Health and Safety, environmental and other critical roofing criteria.

Tel 01283 722588, E-mail [info@marley.co.uk](mailto:info@marley.co.uk) or visit [marley.co.uk/resources](http://marley.co.uk/resources)

## ▲ ACTING RESPONSIBLY AND DELIVERING SUSTAINABLE QUALITY

### BES 6001

Demonstrating our commitment to sustainable building, all our roofing products are certified under the BES 6001 standard for responsible sourcing and therefore contribute to extra credits under BREEAM and The Code for Sustainable Homes.

### QUALITY STANDARD

All our factories in the UK are ISO 9001, 14001 and ISO OHSAS 18001 accredited. They achieve the highest standards in quality, health & safety and the environment.

### CE MARKING

All of our products covered by EN Standard carry an appropriate CE Mark. This means that our products meet the required safety standards and have a guaranteed level of quality.

## ▲ TOOLS

Tools and assets that make design and specification as straightforward as possible.

### SPECRITE

Produce instant NBS clauses that meet the recommendations of British Standards and Codes of Practice: [marley.co.uk/specrite](http://marley.co.uk/specrite)

### TILEFIX

Tool to create fixing specifications based on the geographical location and building dimensions of specific roofing projects: [marley.co.uk/tilefix](http://marley.co.uk/tilefix)

### ROOFING ESTIMATOR

Create a complete bill of materials for your project based on a wide range of building and roof types: [marley.co.uk/estimator](http://marley.co.uk/estimator)

### BIM

BIM Space is a set of free-to-download Building Information Modelling (BIM) objects that provide a standard range of build ups for all of our products: [marley.co.uk/bim](http://marley.co.uk/bim)

### CAD DETAILS

Access to over 2,000 CAD drawings illustrating how specific tile and slate details can be formed: [marley.co.uk/cad](http://marley.co.uk/cad)

### ROOF SYSTEM SELECTOR

Easy-to-use and comprehensive system finder delivering results from choice of pitch, material or tile type: [marley.co.uk/productselector](http://marley.co.uk/productselector)

## ▲ RESOURCES AND TRAINING

### SAMPLES

Samples of clay and concrete interlocking and plain tiles are available on request. Call 01283 722588 or visit [marley.co.uk/samples](http://marley.co.uk/samples)

### FIXING INSTRUCTIONS AND LITERATURE

Comprehensive sitework, fixing and installation literature and videos: [marley.co.uk/resources](http://marley.co.uk/resources)  
All current product and technical literature can be downloaded: [marley.co.uk/downloads](http://marley.co.uk/downloads)

### CPDS

A range of Continuous Professional Development roofing seminars accredited by the RIBA CPD Certification Service. For more information or to make a booking: [marley.co.uk/cpd](http://marley.co.uk/cpd)

### TRAINING

Theoretical, practical, engaging and informative training available at three locations nationwide. [marley.co.uk/training](http://marley.co.uk/training)

This publication is based on the latest data available at the time of printing. Due to product changes, improvements and other factors, the Company reserves the right to change or withdraw information contained herein without prior notice. For specific applications users should refer to the Technical Advisory Service and relevant Standards and Codes of Practice for guidance. The photography shown in the document should not necessarily be taken as recommendations of good practice. The printing process restricts the exact representation of colours. For true colour reference, please request product samples.





**Tell me more**

Call 01283 722588

Email [info@marley.co.uk](mailto:info@marley.co.uk)

Or visit [marley.co.uk](http://marley.co.uk)

Marley, Lichfield Road, Branston, Burton upon Trent, DE14 3HD

