



MIDLANDS LIGHTING SOLUTIONS LTD

Warwickshire Golf Club - Proposed Range Lighting

LIGHTING IMPACT REPORT – MAY 2022

Authored by Lee Burton

MIDLANDS LIGHTING SOLUTIONS LTD | 19 THE GROVE, WARWICKSHIRE B80 7QL

Contents

Executive summary	2
Designer Competence	3
Introduction	4
Site Description.....	5
Environment.....	6
Effects from Light Nuisance through windows on Residents.....	6
Effects from Viewed Source Intensity on Residents and Sightseers	6
Effects from Upward Light (or Sky Glow).....	6
Effects from Artificial Lighting on the natural environment	6
Method of Appraisal	8
Proposed Floodlighting	10
Residual Effects	13
Conclusion.....	16

List of Figures

Figure 1 - Location of Golf Range within the Overall Warwickshire Golf Club Site	5
Figure 2 - hda Ecology drawing demonstrating potential for Bats across site	8
Figure 3 - Calculation grids used for appraisal.....	9
Figure 4 - Proposed layout and mounting height of lights	10
Figure 5 - Toptracer lighting requirement set up.....	10
Figure 6 - Grid 1 Results.....	11
Figure 7 - Grid 6 results.....	11
Figure 8 - Images demonstrating additional spill control measures	12
Figure 9 - Phone Camera picture taken from specific tree looking back to the existing range	13
Figure 10 - Existing range lighting system failed light.....	13
Figure 11 - View from the range looking to the end	14
Figure 12 - View across the range and to the end.....	14
Figure 13 - View from behind the range across the existing lit car park.....	15

List of Tables

Table 1 - Table 2 of ILP GN01 Environmental Zones.....	7
--	---

List of Appendices

Appendix 1 - Calculation Report	17
Appendix 2 – Reference Drawings	18
Appendix 3 - Product Data Sheets	19
Appendix 4 - Reference Guidance Notes.....	20



Executive summary

Midlands Lighting Solutions Ltd have been instructed to evaluate the proposed lighting system for an improved golf range facility at The Warwickshire, the lighting is also required to enable the 'Toptracer' product, which is a state-of-the-art ball tracking system for golfers.

Physical site surveys have been carried out in conjunction with the appointed ecologists, hda, and only a single tree was identified as having the 'potential' for bat activity.

The increase in lighting at this specific tree is negligible, from 0.5 lux to 1.1 lux, which has stated as being within an acceptable maximum from the ecologist.

Other criteria of the evaluation process has been, additional impacts over and above the existing floodlighting system, unnecessary or wasted light spill, good design practices, and the employment of specific additional control measures.

The lighting has been designed specifically by the product supplier, Exled, which has been used for this evaluation, the use of any other product will mean the results and conclusions within this report are not relevant.

A similar number of lights will be installed across the width of the new range, which is greater than the existing footprint and therefore, will be more spread out, we believe the individual wattage of the lights will be significantly lower than the existing due to the use of LED technology.

In our opinion the proposed lighting will provide similar results to that of the existing due to the type of facility (golf range), the use of LED technology will provide more precise optical distribution of light compared to the existing traditional types, which can be controlled with additional accessories and the reduction in overall energy and carbon is positive for the overall environment.

We have suggested that a lighting professional should witness and evidence the setting up of the lighting including, aiming, installation of spill control measures and carrying out sample light tests to prove the scheme has been installed according to this proposal.



Designer Competence

The lighting calculations and technical assessment have been undertaken by me, Lee Burton, Managing Director of Midlands Lighting Solutions Ltd.

I have over 20 years' experience in the lighting and electrical industry, I am a fully qualified electrician (C&G2360) and hold an HNC in Electrical and Electronic Engineering (Edexcel), I have been a member of The Institution of Lighting Professionals (formerly The ILE) for most of the 20 years, I have been an active member regularly attending their Continuing Professional Development programme to ensure I am fully up to date with all advancements in technology, best practices and appraisal methods.

Between 2009 and 2015 I was part of the Midlands Regional Committee, when in 2014 I took the role of Chairman, organising the annual programme of relevant and technical papers for the membership amongst many other duties, which I myself have also given technical papers at The ILP and The Sports and Play Construction Association (SAPCA) events across the country regarding sports lighting systems and LED technology.

During my career, I have attended The ILP Exterior Lighting Module, which was a residential course spanning 4 (not consecutive) weeks and covered topics from lighting, electrical design fundamentals and environmental impacts, to other lighting disciplines such as Architectural and Tunnels, I also attended the South Bank University and the LET Diploma in Lighting, which was an in depth knowledge of the Physics of lighting and methods of implementation across the entire lighting portfolio, I have also undertaken many in house and CPD training modules from reputable manufacturers to demonstrate competence where necessary.



Introduction

The Warwickshire has developed into one of the leading leisure destinations within the region. Amongst other impressive facilities it hosts two championship standard 18-hole golf courses centred around a golf centre.

New investment is needed in the golf offer to enable the course to maintain and build upon its position as a leading course, capable of hosting leading competitions and providing the latest facilities to its members.

The main area in need of upgrading is the existing driving range, sited on the western side of the car park to the golf clubhouse. The driving range currently comprises of nine covered bays at the lower level, additional bays are situated adjacent which, are uncovered and open to the elements.

New innovative technology is now available and being used in other similar facilities for golf driving ranges, which is called 'Toptracer' this system has been installed within over 100 courses within the country and is increasingly becoming a standard expectation for leading golf venues such as The Warwickshire

This lighting impact report has been prepared to support proposals for a new improved range lighting system compared to the current system, this is required to not only ensure efficiencies are being obtained and only necessary lighting is being used but, it is also essential to enable the 'Toptracer' to function correctly and provide vital feedback on practice sessions, this also reduces the need for the more traditional high wattage lights.

Although the assessment will consider the recommendations from The Institution of Lighting Professionals (ILP) Guidance Note for The Reduction of Obtrusive Light 2020 (GN01), the situation is contradictory due to nature and necessity of projecting light in an upward direction and therefore it is a case that the need will be investigated and what can be done to mitigate the impact from anything outside the need for the light.

Our initial survey was carried out in conjunction with ecology professionals, hda and reference is made to their drawing as included in the relevant appendix.



Site Description

The site address is, The Warwickshire, Leek Wooton, Warwick CV35 7QT



Figure 1 - Location of Golf Range within the Overall Warwickshire Golf Club Site

Due to the type of facility, the site is located in open countryside, the existing range is at the south-western corner as shown in Fig.1.

Adjacent to the existing golf range is the golf centre building and a car park which is lit with artificial lighting already.



Environment

Although not entirely relevant for this type of proposed system, The Institution of Lighting Professionals has produced a comprehensive guidance document to assist with quantifying what would be deemed as acceptable maximum thresholds of artificial light through various types of analysis and calculation, therefore we have used this document (Guidance Note for the Reduction of Obtrusive Light GN01 2020) as our baseline reference.

Effects from Light Nuisance through windows on Residents

Light Intrusion (or spill light) is the term used for the consequential spilling of light beyond the boundary of the task area, or sports pitch in this case, being illuminated. The ILP Guidance Notes places a limit on the amount of vertical Illuminance which falls upon the centre of a dwelling window. The suggested maxima values quoted are relative to the amount of light measured as a baseline without the presence of the obtrusive light source.

Effects from Viewed Source Intensity on Residents and Sightseers

Table 4 of the ILP GN01 (extract found in this report Table 2) advises limits on luminaire intensity or viewed source intensity from luminaires to an observer. The greatest problems are usually encountered from poorly designed and inaccurately aimed floodlights, security lighting, or from lighting which is located too close to properties with poor optical control.

Effects from Upward Light (or Sky Glow)

Light emitted above the horizontal either directly from luminaires or indirectly as reflected light from surfaces such as the landscape or buildings, has the potential to cause sky glow. The ILP Guidance Notes place limits on the percentage of direct upward light emitted from the luminaires in their installed attitude, which is dependent upon the Environmental Zone in which the Application Site lies.

In specific circumstances such as the lighting of driving ranges or lighting a building façade from beneath, it is not possible to achieve the desired upward light or flux ratios therefore, measures must be implemented to reduce the impacts as much as reasonably practicable.

Indirect upward light is subject to material reflectance properties. It is not easily quantifiable but is unlikely to be as significant as direct upward light and is not an assessment criterion used in the ILP Guidance Notes.

Effects from Artificial Lighting on the natural environment

The effects of lighting on the natural environment can be difficult to quantify. For this assessment, the effects on bats are considered and the guidance in the document "Bats and Lighting in the UK" considered by minimising the intensity of light spill and also using a colour temperature which is deemed to be 'neutral' and not concentrating in the blue end of the spectrum.

The relevant criteria of upward light, light intrusion and viewed source intensity are assessed in accordance with the following criteria



Table 2: Environmental zones			
Zone	Surrounding	Lighting Environment	Examples
E0	Protected	Dark (SQM 20.5+)	Astronomical Observable dark skies, UNESCO starlight reserves, IDA dark sky places
E1	Natural	Dark (SQM 20 to 20.5)	Relatively uninhabited rural areas, National Parks, Areas of Outstanding Natural Beauty, IDA buffer zones etc.
E2	Rural	Low district brightness (SQM ~15 to 20)	Sparsely inhabited rural areas, village or relatively dark outer suburban locations
E3	Suburban	Medium District Brightness	Well inhabited rural and urban settlements, small town centres of suburban locations
E4	Urban	High District Brightness	Towns/City Centres with high levels of night-time activity

Table 1 - Table 2 of ILP GN01 Environmental Zones

Curfew is stated within the guidance notes as the time at which stricter requirements (for the control of obtrusive Light) will apply and in the absence of any stated time from the planning authority this is suggested as being 23:00, however in reality times of operation have been stated as until 22:00 Monday to Friday and 21:00 for weekends and the lights will only be used when necessary, predominantly during the winter months and not the summer.



Method of Appraisal

A day and night-time survey was carried out on the 31st of January, the daytime visit was a joint visit with a representative from hda Ecology to try and determine the areas where specific consideration was required, and a return visit was made after dark by us to measure the existing range floodlighting.

Fig 2 is an initial drawing provided by hda Ecology showing the areas of potential bat activity, please note that no evidence of bats was observed due to the time of year, this was based simply on the type of tree and whether there were characteristics of the tree which could house bats such as crevasses.



Figure 2 - hda Ecology drawing demonstrating potential for Bats across site

Please note that the golf range was in use at the time of our survey and caution was required when obtaining these results and only measurements that were felt necessary were recorded.

Regardless of the potential for bat activity, 4 actual measurements were taken along the tree line to the south as highlighted in Fig 2, then a visual survey was carried out across the site.

A lighting proposal has been provided by the preferred lighting supplier, Exled. They have also provided the necessary measurements files for us to independently verify and evaluate the effects of lighting outside of what is required for the 'Toptracer' system.

Firstly, the proposed lighting and relevant performance grids are set up in our own lighting software to ensure we have the correct set up as per the suppliers' calculations and in accordance with the 'Toptracer' requirements.



The lighting calculation software used is Philips CalcuLUX 7.9.0.0, the manufacturer has developed this software specifically for sports lighting installations and it provides the necessary capability to undertake obtrusive light calculations in full and independently by uploading others product data. The company (Philips Lighting) is ISO Approved, and the software is widely accepted and used throughout the industry in the UK and the world.



Figure 3 - Calculation grids used for appraisal

Once the lighting system has been modelled correctly, a series of grids have been created to evaluate the effects as noted:

1. Light distribution width & height at 30m from range (shown in Fig 6)
2. Light distribution width & height at 90m from range (See attached calculation)
3. Light distribution width & height at 150m from range (See attached calculation)
4. Light distribution width & height at 210m from range (See attached calculation)
5. Light distribution length & height through centre (See attached calculation)
6. Vertical light spill onto tree line to south of range (shown in Fig 7)



Proposed Floodlighting

The lighting design has been carried out by the preferred supplier, Exled and a copy of the calculation is appended to this report for information.

Based on the revised range layout consisting of a two storey and single storey bay combination, there will be 4 lights installed at 7.4m above the range floor for the 2 storey bays and 5 lights will be installed at 3.8m above the range floor for the single storey bays.



Figure 4 - Proposed layout and mounting height of lights

The Toptracer system requires a specific lighting performance to enable it to function as intended and the full system requirements are appended to this report for information.

With regards to the lighting element, it is suggested that a minimum 30 lux should be achieved over a vertical grid spanning the range width, 50m in front of the bays and up to a height of 30m as shown in Fig 5.

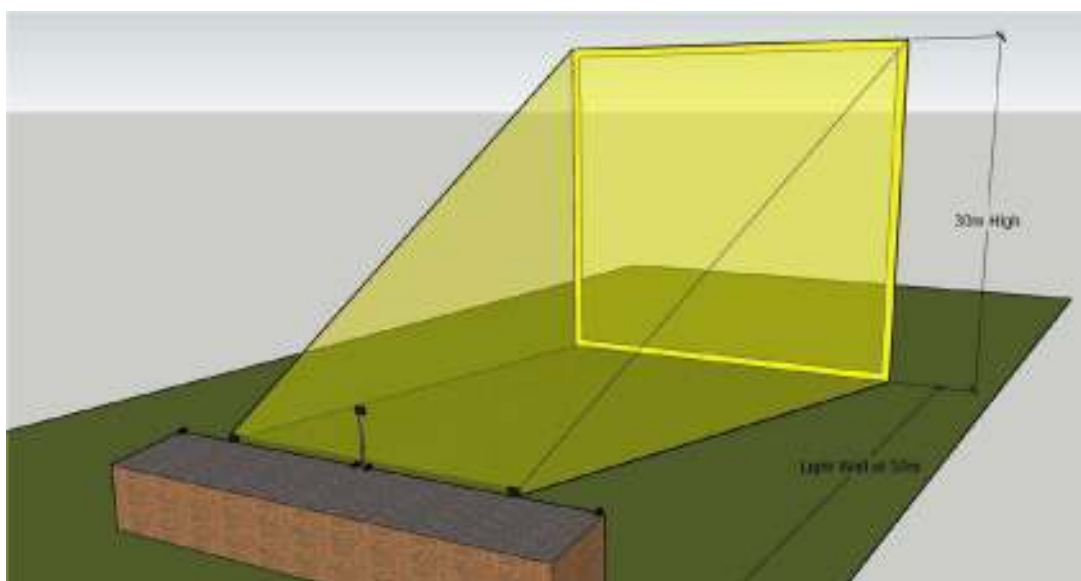

Figure 5 - Toptracer lighting requirement set up



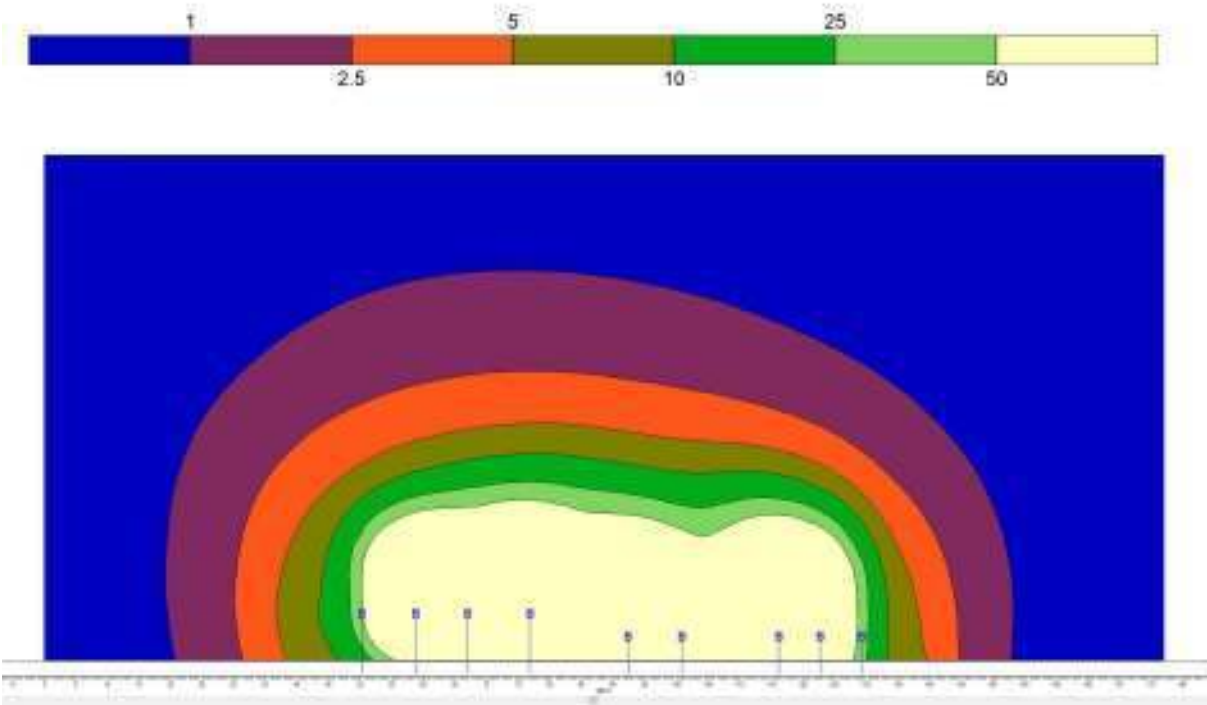

Figure 6 - Grid 1 Results

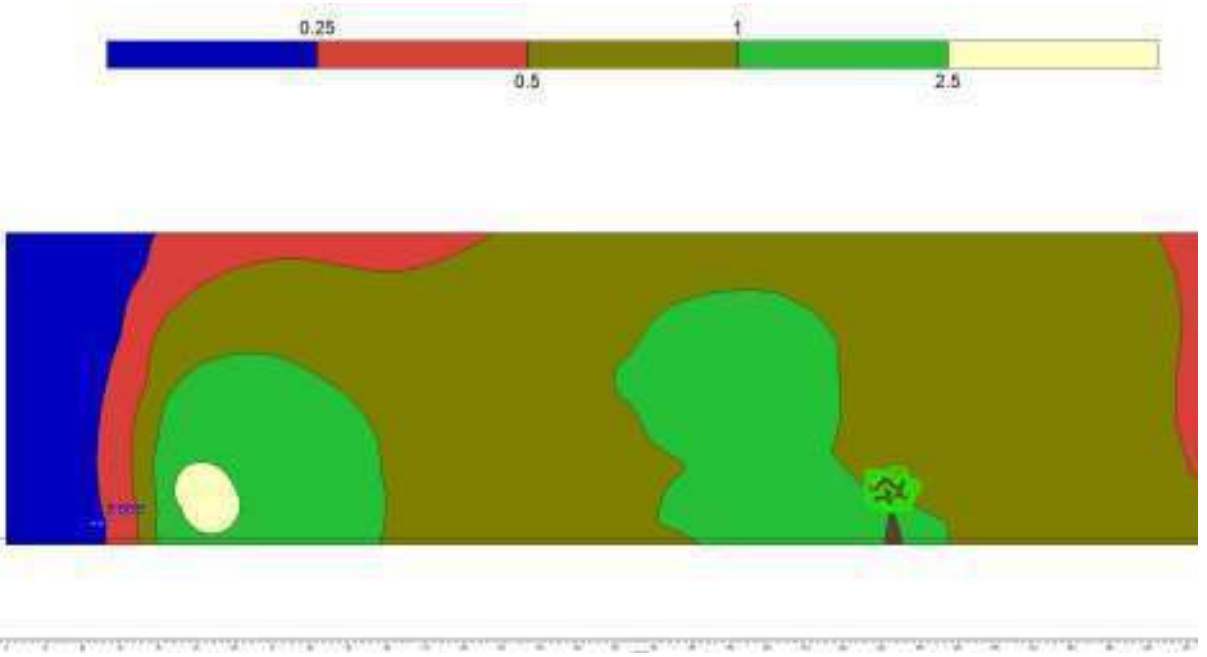

Figure 7 - Grid 6 results



The proposed floodlights, to suit the Toptracer system lighting requirements, is the Exled Galaxy TTX-US 300W with symmetrical beam, this is required to provide the upward required to track the golfers ball trajectory.

There are a number of versions and additions that are possible for the proposed light, it should be confirmed that a colour temperature of no more that 4000K should be used, all lights shall have the 'hood' fitted to reduce upward light where possible and 'barn doors' should be installed to reduce the amount of side spill as much as practicable.



Figure 8 - Images demonstrating additional spill control measures



Residual Effects

Typically for this type of report, there is a specific dwelling or observer that the results can be evaluated against however, in this circumstance, the lighting has been evaluated against unnecessary or wasted light, best design practice and most importantly, known or suspected ecological impacts.

According to hda Ecologists initial report, there was only a single tree that had the potential to house bats although, this was not evidenced and the other areas of foliage around the range, had little or no potential and as there is already a similar lighting system in place and being used currently, the results for this specific tree are compared.

During our night-time survey, a single measurement was taken at the tree 1.5m above the ground level which was approximately 2m below the range surface due to the topography of the land as seen in Fig 7.



Figure 9 - Phone Camera picture taken from specific tree looking back to the existing range

The measured result was 0.5 lux with the existing lighting on, it must be noted that the light closest to the tree line was not operating at the time of the survey as shown in Fig 8. So, the results may be slightly more.

According to our calculations, the new results for the same location will be 1.1 lux vertically when all lights are on, which demonstrates a reasonable increase in light at this sensitive location.



Figure 10 - Existing range lighting system failed light

Historically, there are many types of range lighting systems that are in use, these are end lighting systems, side lighting and berm lighting. With the advent of technology to provide instant feedback on performance within the majority of sports now, there are certain requirements to enable this technology to behave as intended and in this case, its lighting.



As noted, there is already an existing end lighting system in place, this consisted of 9 No. high wattage (probably in the region of 1000W each) floodlights, although the exact types and characteristics cannot be confirmed, it is our professional opinion the lights were at least 5000 kelvin colour temperature, and they were all concentrated within the width of the existing range bays footprint.

Due to the type of lighting system employed, it is unpractical to measure the full impact of the existing lighting to be able to compare this to the proposed and as the existing lighting has been installed and probably changed throughout its life for varying product types, we are unable to accurately model the lighting too.

When the new range is built the proposed lighting units are significantly lower wattage and spread about an increased width range.



Figure 11 - View from the range looking to the end



Figure 12 - View across the range and to the end

As can be seen the existing lighting is as expected for this type of system and according to our calculations, the proposed system will produce similar results.





Figure 13 - View from behind the range across the existing lit car park

We strongly recommend that the installation is carried out with a lighting professional to demonstrate the correct use of additional accessories such as 'hoods' and 'barn doors' the accurate aiming of the floodlights should also be witnessed and documented to achieve the minimum performance whilst minimising any unnecessary light spill outside the application area and also the specific ecological locations as identified by hda ecologists.

Conclusion

The site is already being used as a golf range complete with high wattage floodlights installed above and directed to the end of the range, this intentionally directs light in an upwards direction to track the golfers ball trajectory and distance.

The club wish to improve the facilities and at the same time install the latest technology in ball flight tracking, which requires a specific lighting performance.

This report has been produced to demonstrate that all possible considerations have been made and that the employer (the Club Company) are acting in a responsible way by ensuring the proposed lighting system is fit for purpose but does not cause unnecessary additional impact to the environment.

Although the footprint of the proposed range will be larger, there will be the same number of light units (9) and the wattage will be significantly lower in our opinion.

The appointed ecologists, hda, have undertaken a visual bat survey and identified a single tree with the 'potential' to house bats.

This has been the target of the attention with regards to lighting and although we will see an increase in lighting from 0.5 lux to 1.1 lux, this is a relatively low level of lighting which was deemed acceptable by the hda representative.

In our opinion and as observed at our night-time survey, the results will be comparable to the existing system due to the type of facility and purpose of the lighting system.

The preferred lighting supplier Exled has provided specific lighting data, which is unique to their product, we strongly suggest that this product is used to ensure that the results are as expected, the use of any other product will yield unknown results and this report will no longer be valid or relevant.

The maximum colour temperature of the lights should be 4000K and an independent lighting professional should witness and evidence the specific aiming and use of accessories to reduce unwanted wasted light such as 'hoods' or 'barn doors'.



Appendix 1 - Calculation Report



The Warwickshire

Lighting Impact Study

Project code: MLS753
Date: 11-03-2022
Customer: The Club Company
Customer Representative: Mark Warne

Designer: Midlands Lighting Solutions

Description: This calculation should be read in conjunction with the report, MLS753 WGC Lighting Impact Report_A.

The original lighting design has been undertaken by Exled who are suppliers of the light measurement files

Should any other product be used, this calculation will no longer be valid or relevant and the evaluation process should be repeated to ensure mitigation.

Additional measures will be employed such as hoods for all lights and barn doors for relevant lights on the extremes.

9 x Exled Galaxy 300 TTX-US, CCT of 4000K

The nominal values shown in this report are the result of precision calculations, based upon precisely positioned luminaires in a fixed relationship to each other and to the area under examination. In practice the values may vary due to tolerances on luminaires, luminaire positioning, reflection properties and electrical supply.

Midlands Lighting Solutions LTD

19 The Grove
Studley
Warwickshire
B80 7QL

Mobile Phone: 07757 830 436
E-Mail: enquiries@midlandslightingsolutions.co.uk



MIDLANDS LIGHTING SOLUTIONS LTD

CalcuLuX Area 7.9.0.0

Table of Contents

1.	Project Description	3
1.1	Top Project Overview	3
2.	Summary	4
2.1	Project Luminaires	4
2.2	Calculation Results	4
3.	Calculation Results	5
3.1	50m Wall: Graphical Table	5
3.2	Spill: Filled Iso Contour	6
3.3	Spill Height: Filled Iso Contour	7
3.4	Tree Line South: Filled Iso Contour	8
3.5	Width @30m: Filled Iso Contour	9
3.6	Width @90m: Filled Iso Contour	10
3.7	Width @150m: Filled Iso Contour	11
3.8	Width @ 210m: Filled Iso Contour	12
3.9	Ev Spill: Iso Contour	13
4.	Luminaire Details	14
4.1	Project Luminaires	14
5.	Installation Data	15
5.1	Legends	15
5.2	Luminaire Positioning and Orientation	15

1. Project Description

1.1 Top Project Overview

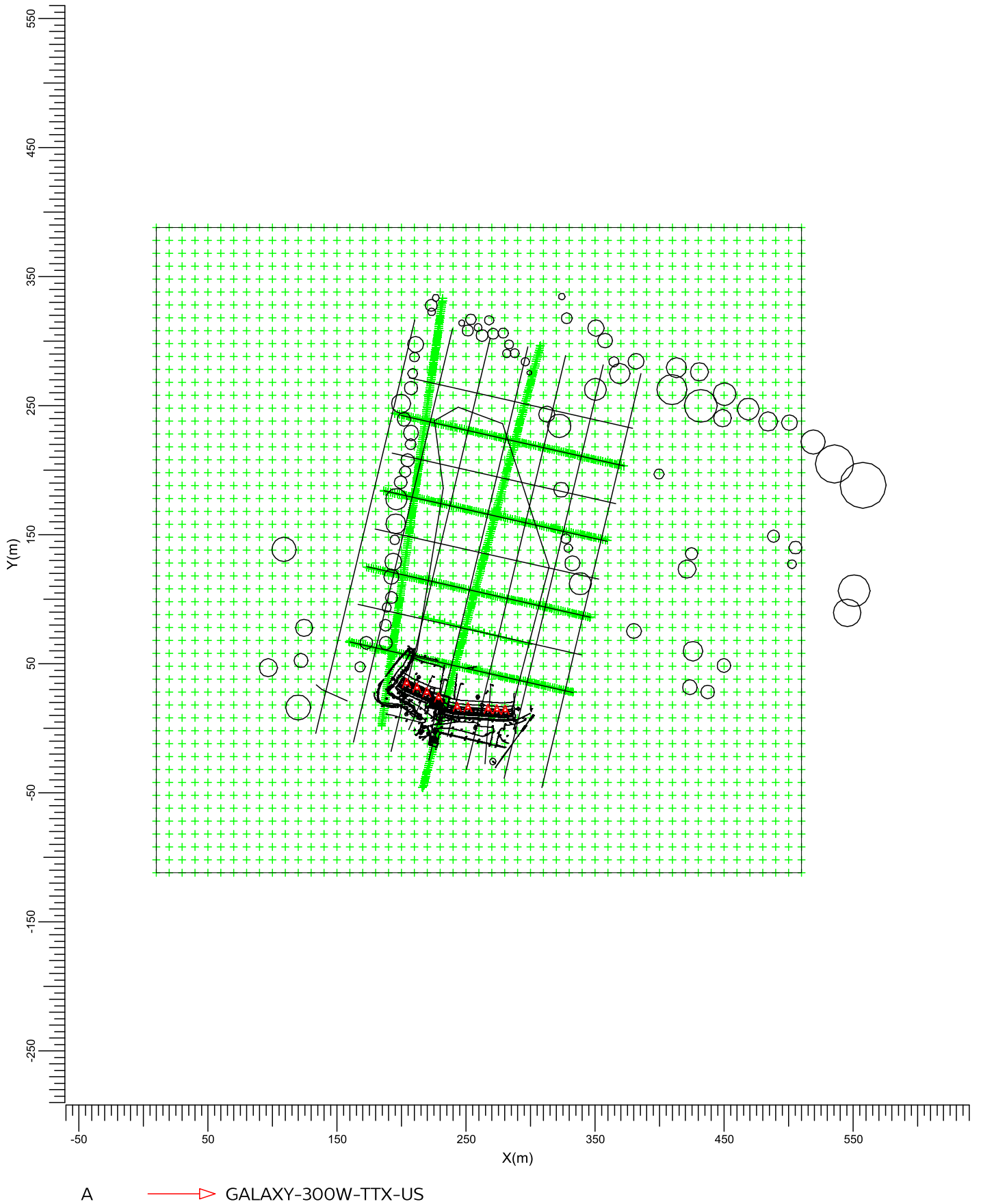

Scale
1:4000

2. Summary

2.1 Project Luminaires

Code	Qty	Luminaire Type	Lamp Type	Power (W)	Flux (lm)
A	9	GALAXY-300W-TTX-US	1 * 5050+XTE	299.7	1 * 46958

The total installed power: 2.70 (kWatt)

2.2 Calculation Results

(Il)luminance Calculations:

Calculation	Type	Unit	Ave	Min	Max	Min/Ave	Min/Max
50m Wall	Vertical Illuminance	lux	82.5	4.4	208.5	0.05	0.02
Spill	Surface Illuminance	lux		0.00	58.50		
Spill Height	Surface Illuminance	lux		0.00	37.81		
Tree Line South	Vertical Illuminance	lux		0.01	2.88		
Width @30m	Vertical Illuminance	lux		0.0	623.3		
Width @90m	Vertical Illuminance	lux		0.3	153.0		
Width @150m	Vertical Illuminance	lux		0.6	59.5		
Width @ 210m	Surface Illuminance	lux		1.9	27.1		
Ev Spill	Vertical Illuminance	lux		0.00	5844.77		

Obtrusive Light Calculations:

The upward light ratio (ULR) is 0.62.

3. Calculation Results

3.1 50m Wall: Graphical Table

Grid : 50m Wall
 Calculation : Vertical Illuminance in -Y direction (lux)
 Height above grid : 0.00 m

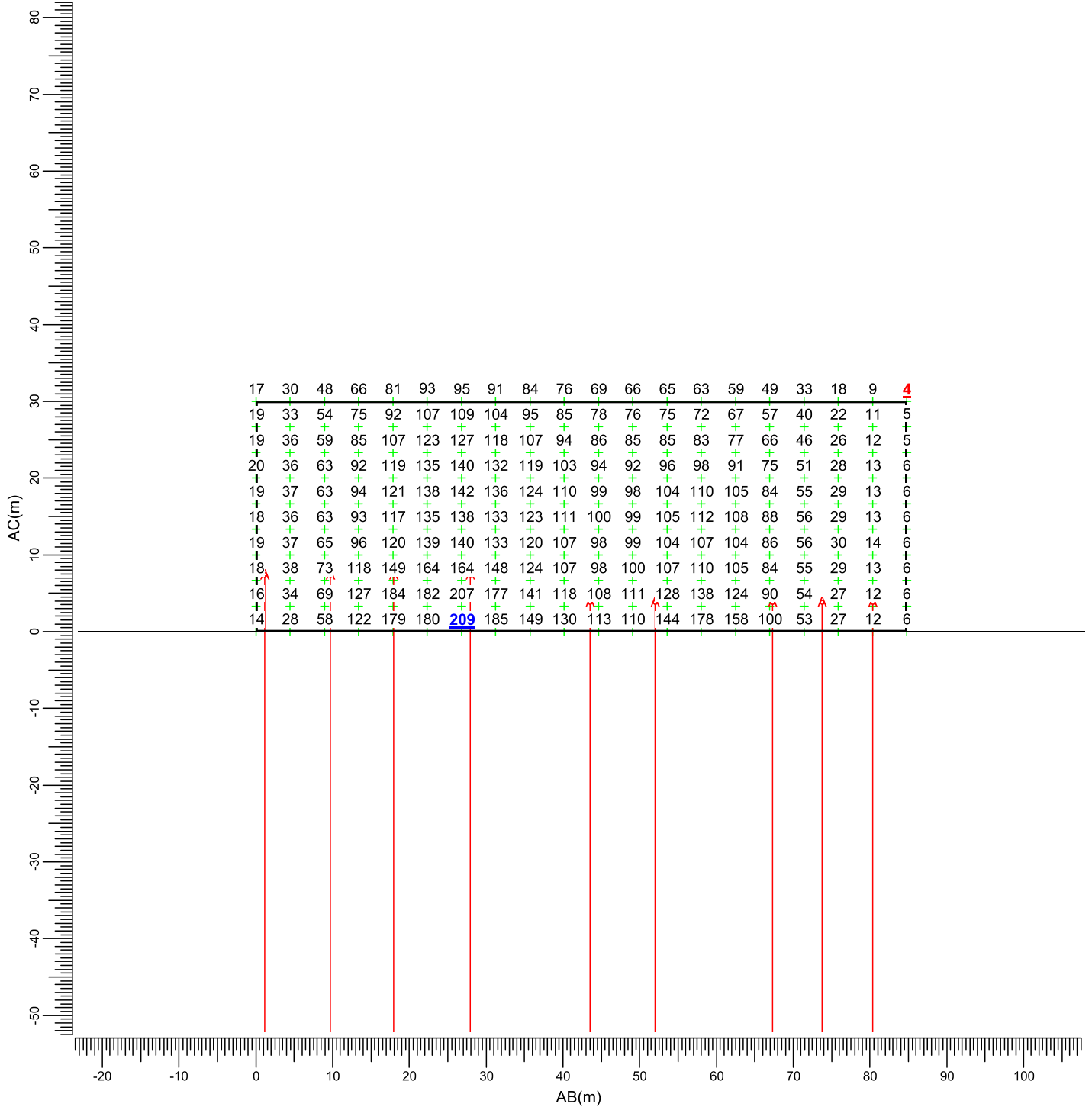

(216.29, 86.45, 30.00) C-----D (298.34, 65.04, 30.00)
 | |
 (216.29, 86.45, -0.00) A-----B (298.34, 65.04, -0.00)

A GALAXY-300W-TTX-US

Average	Minimum	Maximum	Min/Ave	Min/Max	Project maintenance factor	Scale
82.5	4.4	208.5	0.05	0.02	1.00	1:750

3.2 Spill: Filled Iso Contour

Grid : Spill at Z = -0.00 m
Calculation : Surface Illuminance (lux)

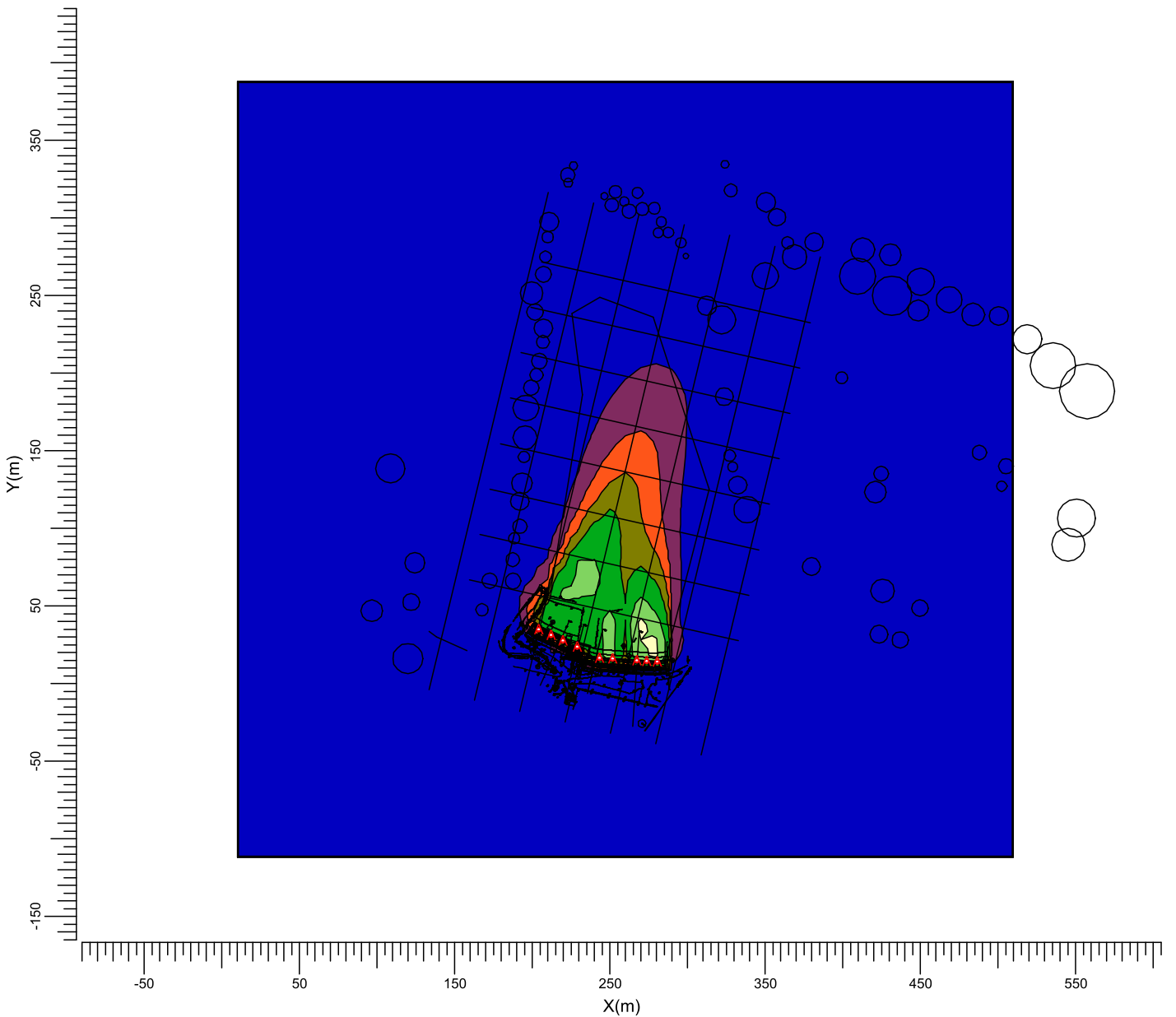

A GALAXY-300W-TTX-US

Minimum
0.00

Maximum
58.50

Project maintenance factor
1.00

Scale
1:4000

3.3 Spill Height: Filled Iso Contour

Grid : Spill Height
Calculation : Surface Illuminance (lux)

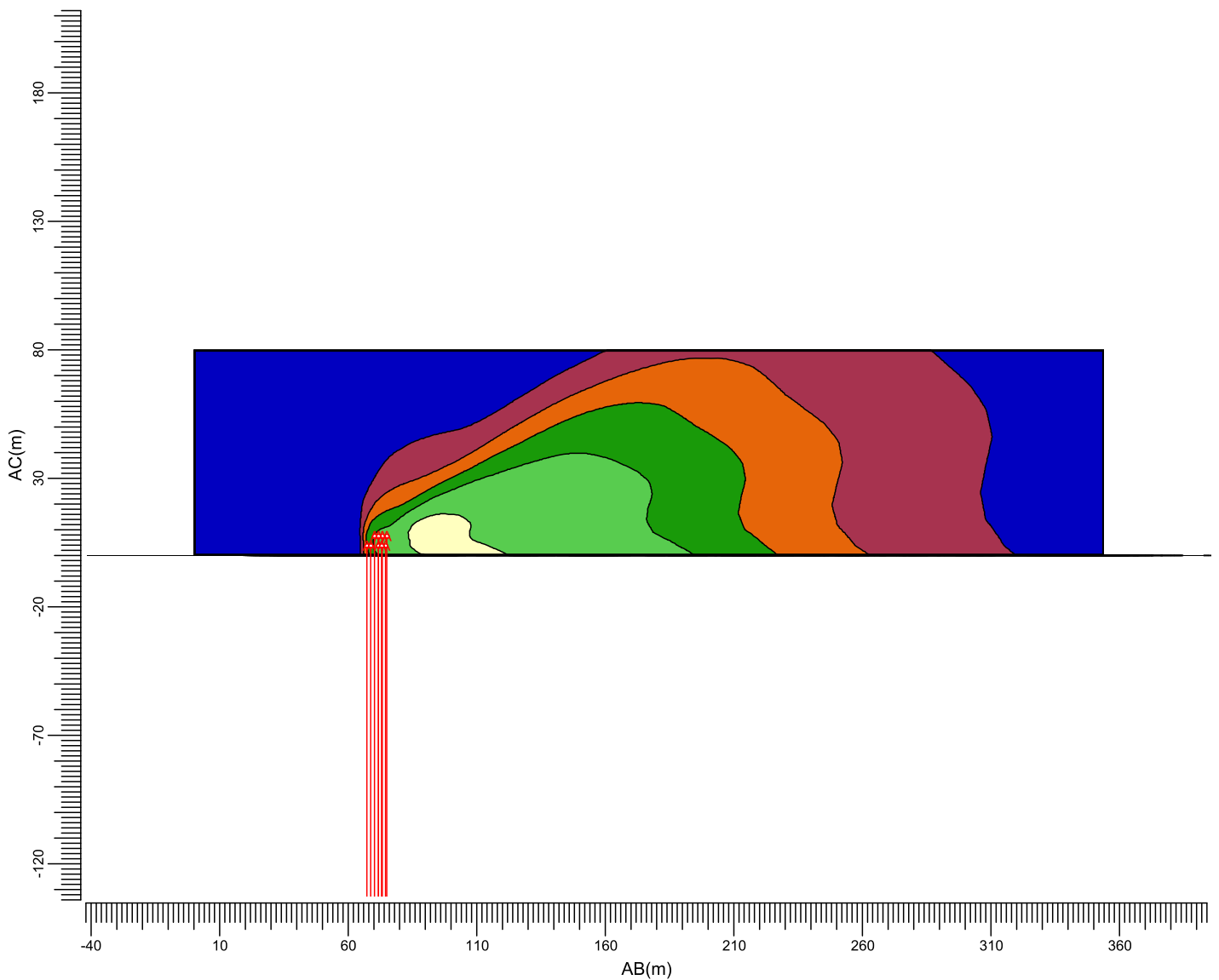
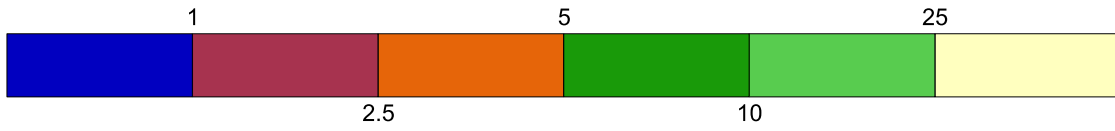

(216.42, -45.97, 80.00) C-----D (307.45, 296.21, 80.00)
 (216.42, -45.97, -0.00) A-----B (307.45, 296.21, -0.00)

A GALAXY-300W-TTX-US

Minimum
0.00

Maximum
37.81

Project maintenance factor
1.00

Scale
1:2500

3.4 Tree Line South: Filled Iso Contour

Grid : Tree Line South
 Calculation : Vertical Illuminance in +X direction (lux)
 Height above grid : 0.00 m

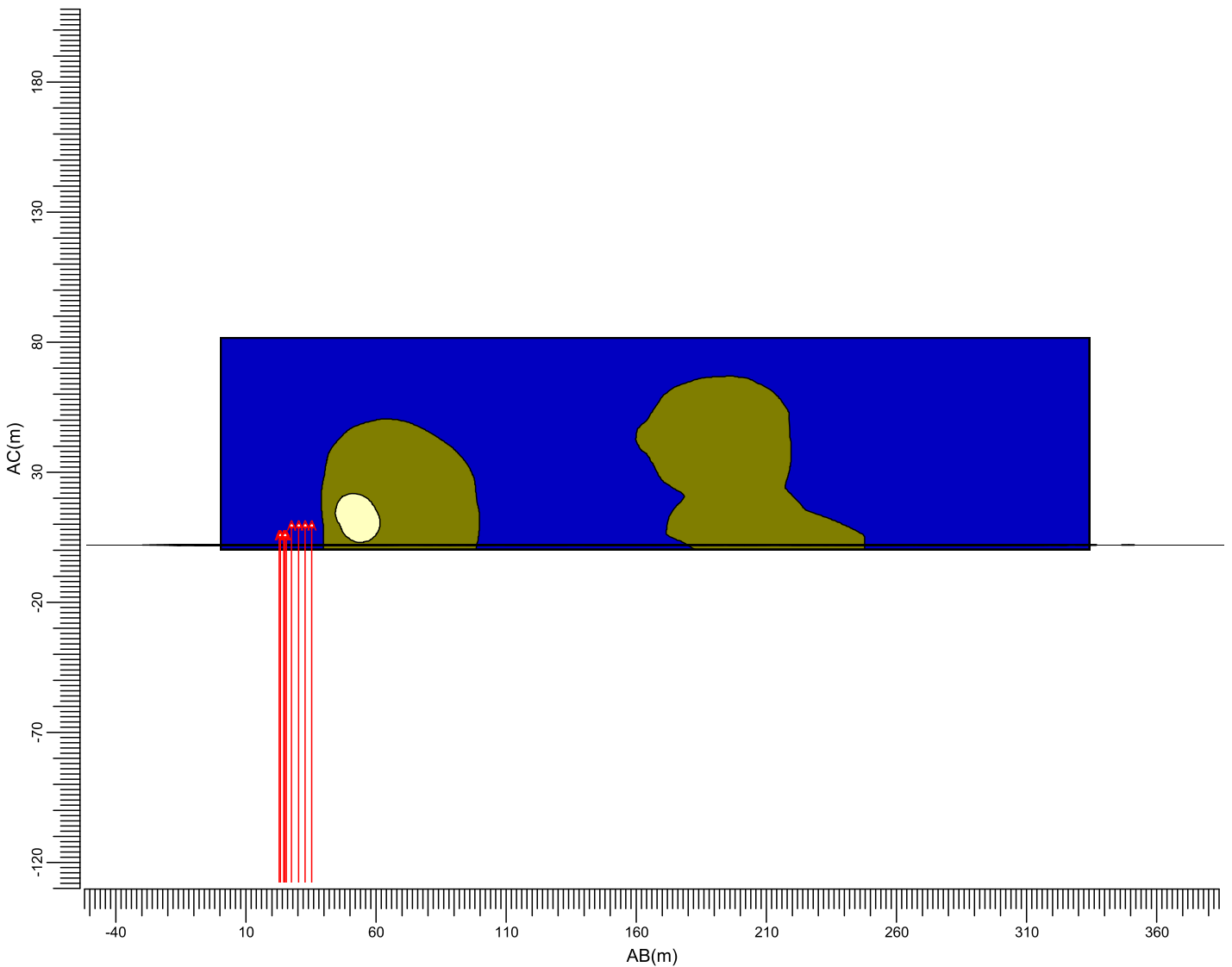

(184.46, 2.13, 80.00) C----D (231.92, 333.01, 80.00)
 (184.46, 2.13, -2.00) A----B (231.92, 333.01, -2.00)

A GALAXY-300W-TTX-US

Minimum
0.01

Maximum
2.88

Project maintenance factor
1.00

Scale
1:2500

3.5 Width @30m: Filled Iso Contour

Grid : Width @ 30m
 Calculation : Vertical Illuminance in -Y direction (lux)
 Height above grid : 0.00 m

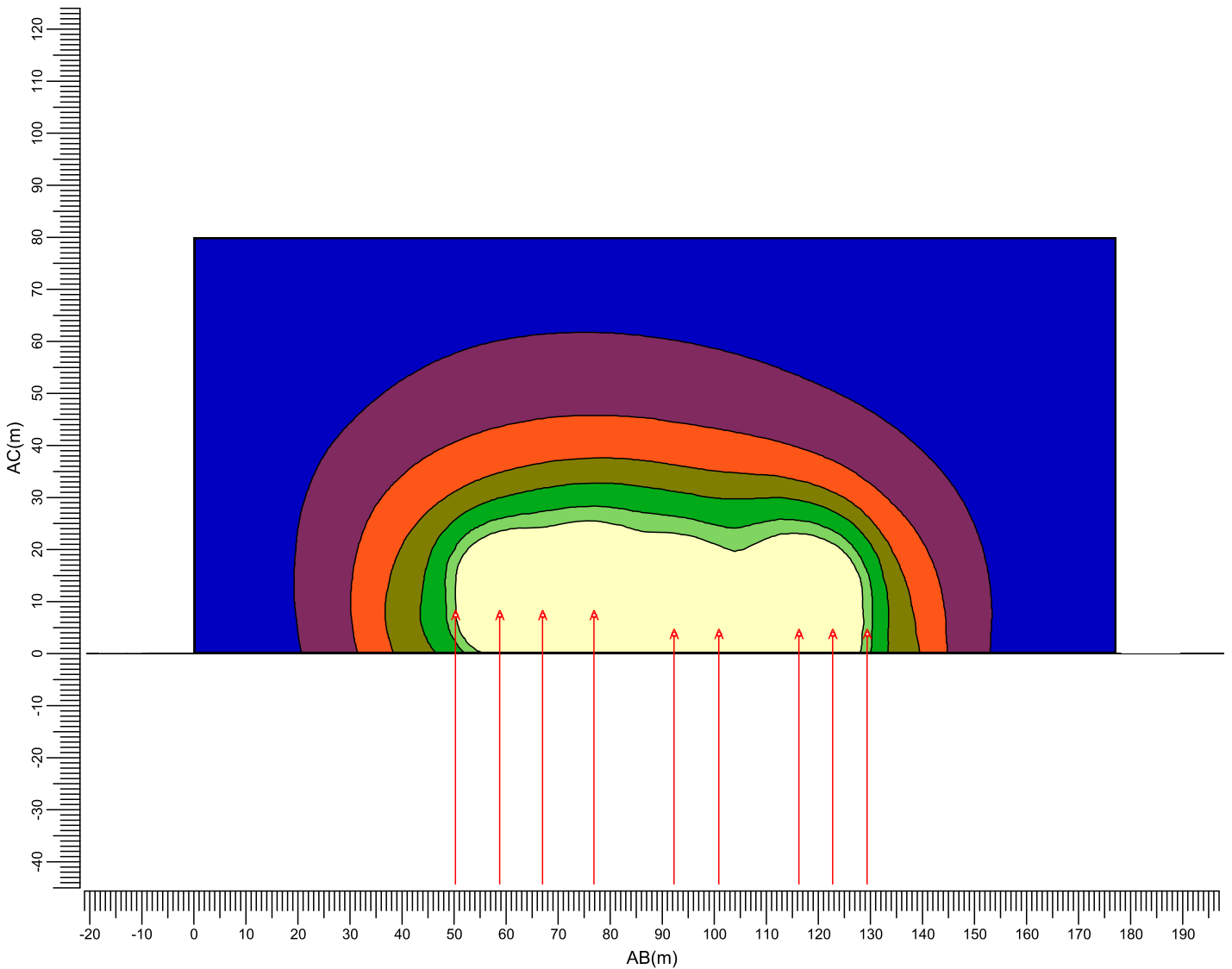

(159.62, 66.63, 80.00) C----D (332.60, 28.04, 80.00)
 (159.62, 66.63, -0.00) A----B (332.60, 28.04, -0.00)

A GALAXY-300W-TTX-US

Minimum
0.0

Maximum
623.3

Project maintenance factor
1.00

Scale
1:1250

3.6 Width @90m: Filled Iso Contour

Grid : Width @ 90m
 Calculation : Vertical Illuminance in -Y direction (lux)
 Height above grid : 0.00 m

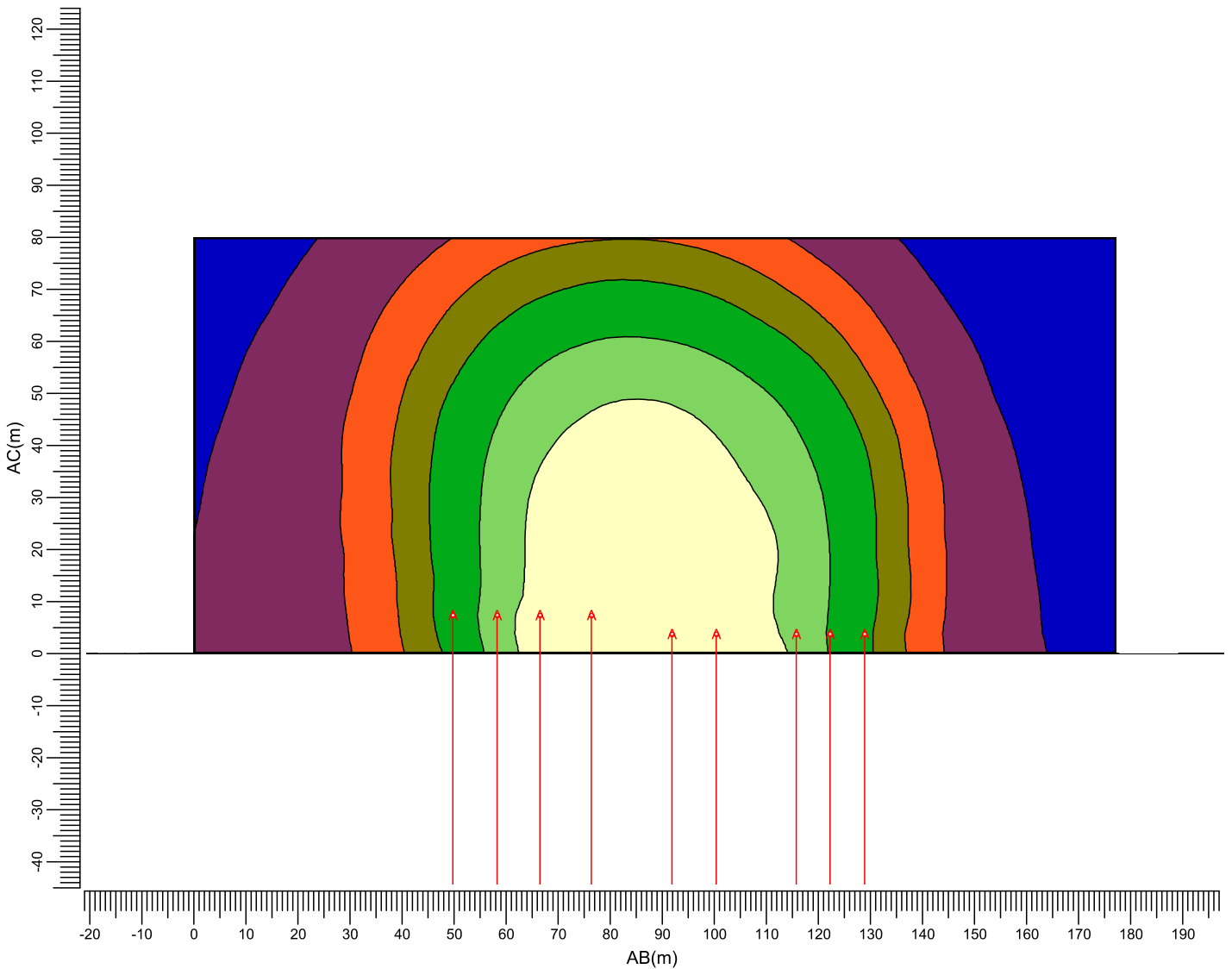

(173.06, 124.72, 80.00) C-----D (346.04, 86.14, 80.00)
 | |
 (173.06, 124.72, -0.00) A-----B (346.04, 86.14, -0.00)

A GALAXY-300W-TTX-US

Minimum
0.3

Maximum
153.0

Project maintenance factor
1.00

Scale
1:1250

3.7 Width @150m: Filled Iso Contour

Grid : Width @ 150m
 Calculation : Vertical Illuminance in -Y direction (lux)
 Height above grid : 0.00 m

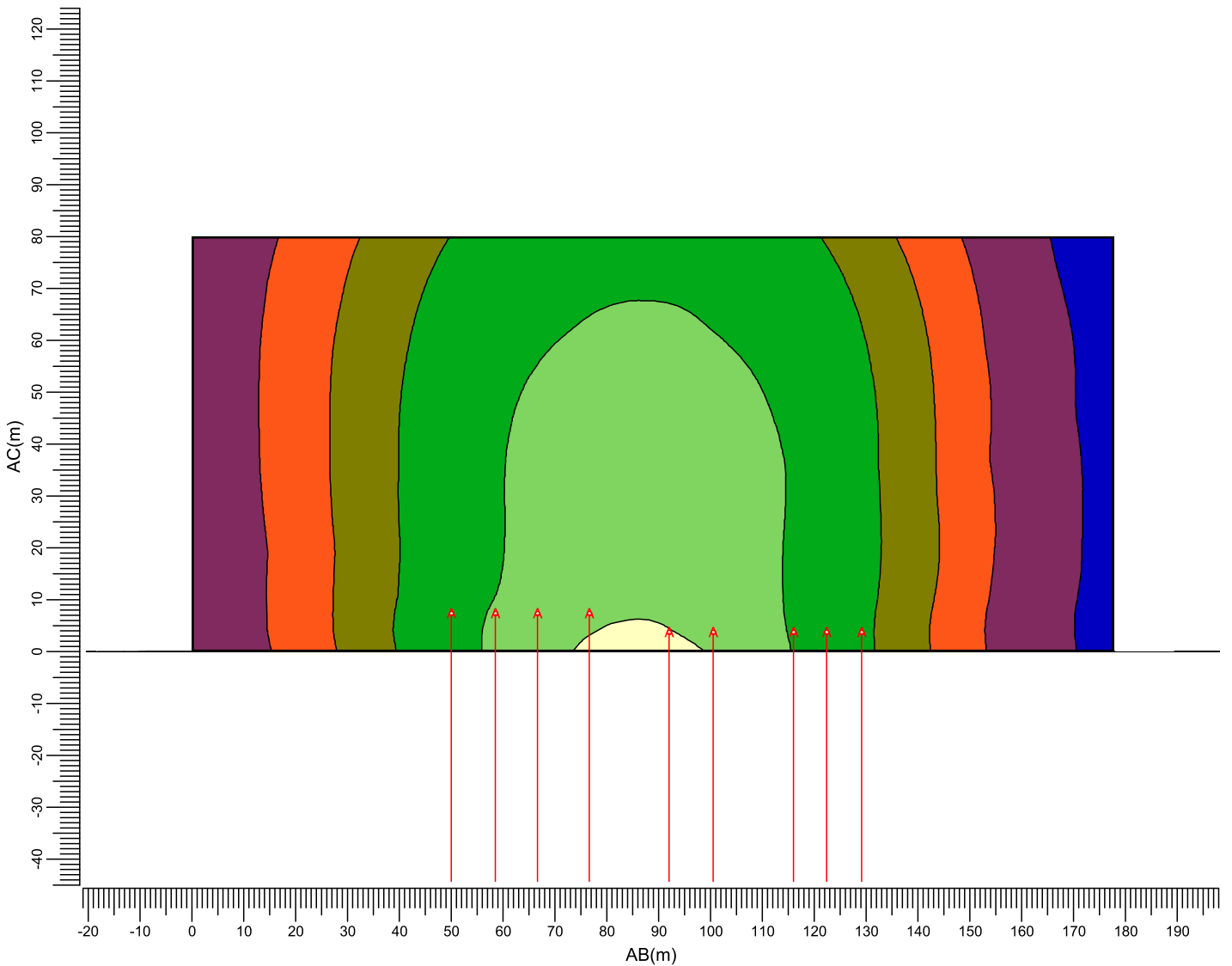

(186.07, 184.11, 80.00) C----D (359.48, 145.53, 80.00)
 (186.07, 184.11, -0.00) A----B (359.48, 145.53, -0.00)

A GALAXY-300W-TTX-US

Minimum
0.6

Maximum
59.5

Project maintenance factor
1.00

Scale
1:1250

3.8 Width @ 210m: Filled Iso Contour

Grid : Width @ 210m
Calculation : Surface Illuminance (lux)

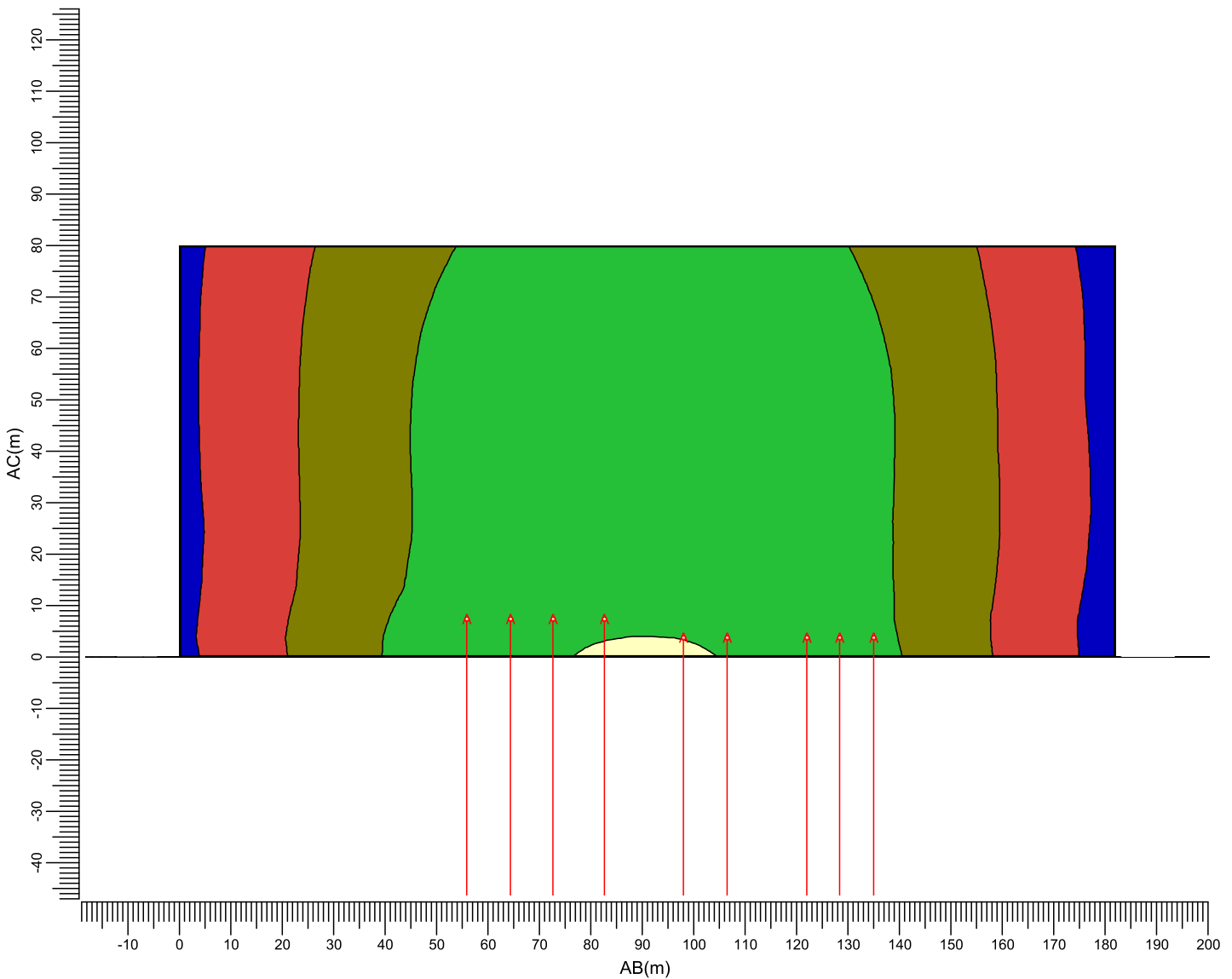

(194.74, 243.94, 80.00) C----D (372.05, 203.19, 80.00)
 (194.74, 243.94, -0.00) A----B (372.05, 203.19, -0.00)

A GALAXY-300W-TTX-US

Minimum
1.9

Maximum
27.1

Project maintenance factor
1.00

Scale
1:1250

3.9 Ev Spill: Iso Contour

Grid : Spill at Z = -0.00 m
 Calculation : Vertical Illuminance in -Y direction (lux)
 Height above grid : 5.00 m

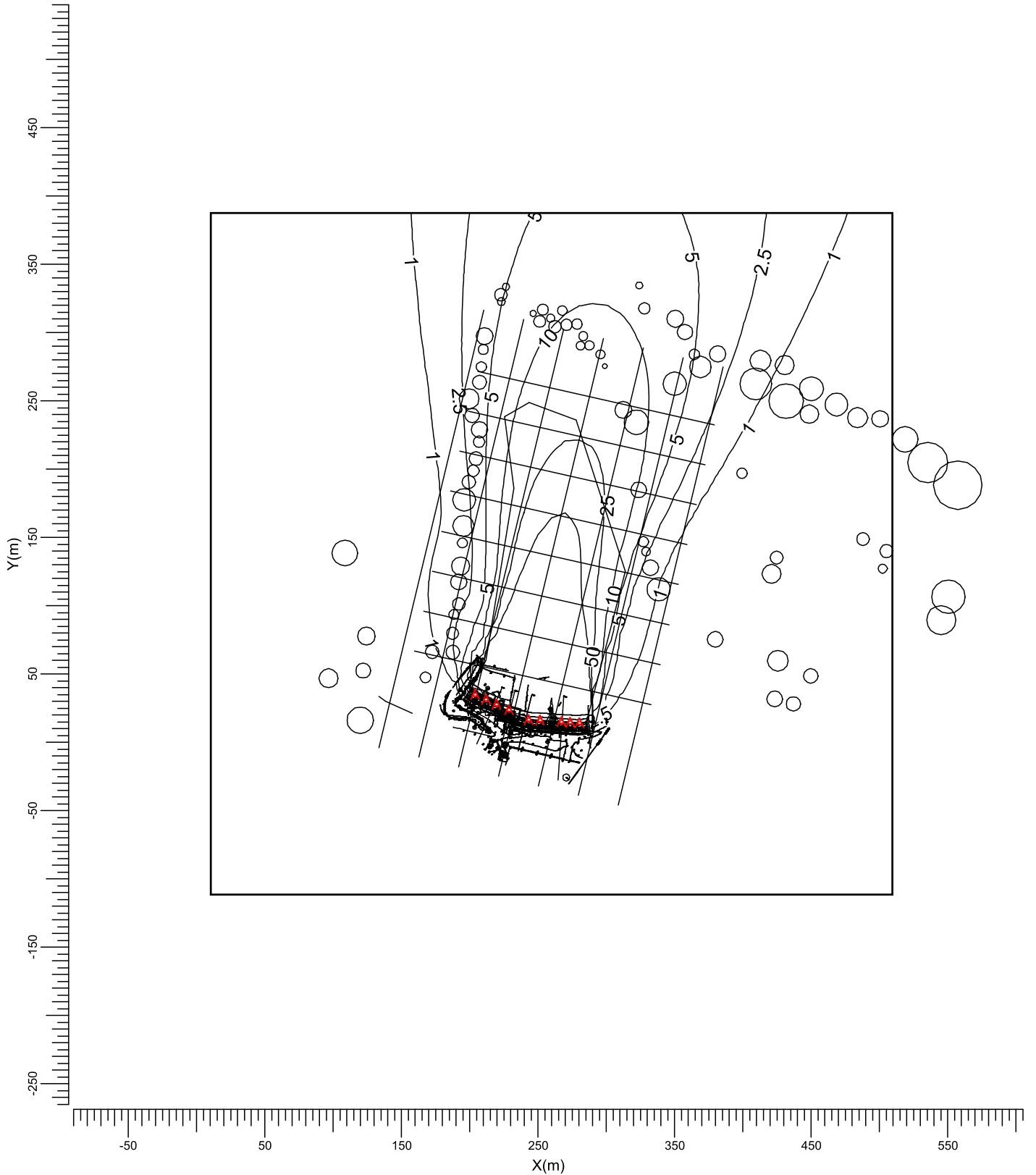

A  GALAXY-300W-TTX-US

Minimum
0.00

Maximum
5844.77

Project maintenance factor
1.00

Scale
1:4000

4. Luminaire Details

4.1 Project Luminaires

GALAXY-300W-TTX-US 1x5050+XTE

Light output ratios

DLOR	: 0.38
ULOR	: 0.62
TLOR	: 1.00
Lamp flux	: 46958 lm
Luminaire wattage	: 299.7 W

Note: Luminaire data not from database.

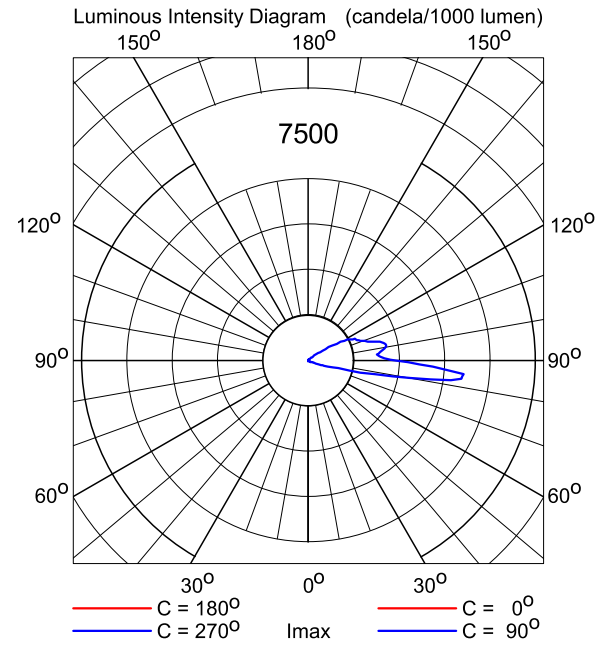

5. Installation Data

5.1 Legends

Project Luminaires:

Code	Qty	Luminaire Type	Lamp Type	Flux (lm)
A	9	GALAXY-300W-TTX-US	1 * 5050+XTE	1 * 46958

5.2 Luminaire Positioning and Orientation

Qty and Code	Position			Aiming Angles		
	X (m)	Y (m)	Z (m)	Rot.	Tilt90	Tilt0
1 * A	203.99	34.87	7.40	58.6	0.0	0.0
1 * A	211.86	31.08	7.40	67.8	0.0	0.0
1 * A	219.51	27.62	7.40	66.7	0.0	0.0
1 * A	228.76	23.49	7.40	75.6	0.0	0.0
1 * A	243.01	16.54	3.80	85.3	0.0	0.0
1 * A	251.59	15.84	3.80	86.4	0.0	0.0
1 * A	267.17	14.83	3.80	86.5	0.0	0.0
1 * A	273.68	14.37	3.80	87.3	0.0	0.0
1 * A	280.43	14.13	3.80	98.4	0.0	0.0



The Warwickshire

Installation :

Project number :

Customer :

Processed by : Mark Ruthers

Date : 04.10.2021

Project description:

The following values are based on precise calculations performed on calibrated lamps and luminaires, and their configurations, whereby gradual, unavoidable deviations can occur in practice. All guarantee claims are excluded for the specified data.

This exclusion of liability applies irrespective of the legal grounds for both damages and consequential damages suffered by users and third parties.

Object : The Warwickshire
Installation :
Project number :
Date : 04.10.2021



1 Luminaire data

1.1 EXLED, Galaxy-400W-TTX (Galaxy-400W-TTX.ies)

1.1.1 Data sheet

Manufacturer: EXLED

Galaxy-400W-TTX.ies

Galaxy-400W-TTX

Luminaire data

Luminaire efficiency : 99.6%
Luminaire efficacy : 122.78 lm/W
Classification : A70 ↓98.1% ↑1.9%
CIE Flux Codes : 85 95 99 98 100
UGR 4H 8H : 17.8 / 26.0
Power : 396 W
Luminous flux : 48620.7 lm

Equipped with

Quantity : 1
Designation :
Colour :
Luminous flux : 48816 lm

Dimensions : 350 mm x 642 mm x 235 mm

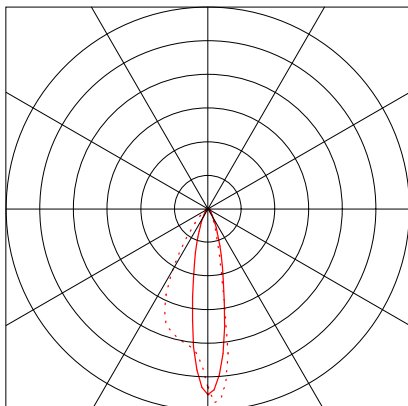

Object : The Warwickshire
Installation :
Project number :
Date : 04.10.2021



2 Exterior 1

2.1 Description, Exterior 1

2.1.1 Floor plan



Object : The Warwickshire
Installation :
Project number :
Date : 04.10.2021



2.1 Description, Exterior 1

2.1.2 3D view, View 1



Object : The Warwickshire
 Installation :
 Project number :
 Date : 04.10.2021



2 Exterior 1

2.2 Summary, Exterior 1

2.2.1 Result overview, Measuring area 1



1 51 101 151 201 251 301 351 401 451 501 x [m]

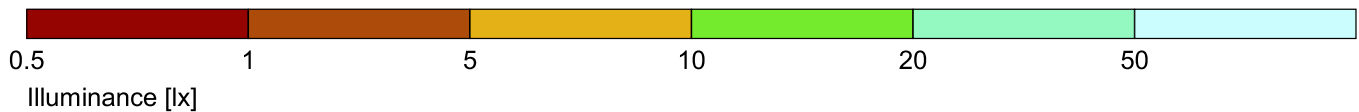

General

Calculation algorithm used	Average indirect fraction
Height of evaluation surface	0.00 m
Maintenance factor	0.80
Total luminous flux of all lamps	390528 lm
Total power	3168 W
Total power per area (165201.00 m ²)	0.02 W/m ²

Illuminance

Average illuminance	Em	4.6 lx
Minimum illuminance	Emin	0.1 lx
Maximum illuminance	Emax	36.4 lx
Uniformity U _o	Emin/Em	1:32.7 (0.03)
Diversity U _d	Emin/Emax	1:258 (0)

Type No.\Make

1	8	EXLED	
		Order No.	: Galaxy-400W-TTX.ies
		Luminaire name	: Galaxy-400W-TTX
		Equipment	: 1 x 396 W / 48816 lm

Object : The Warwickshire
 Installation :
 Project number :
 Date : 04.10.2021



2 Exterior 1

2.3 Calculation results, Exterior 1

2.3.2 Table, Reference plane 1.1 (E)

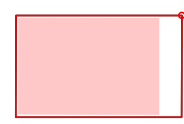
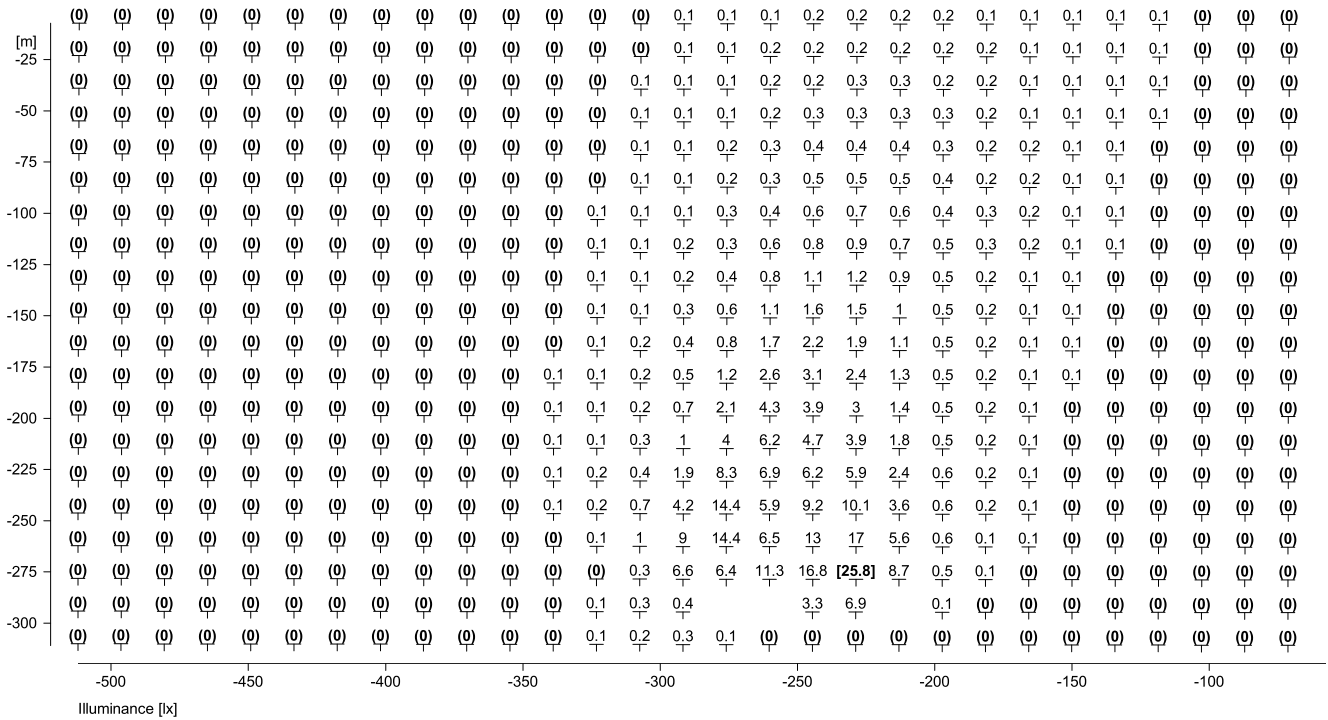

Part1

Height reference plane : 0.00 m
 Average illuminance Em : 0.5 lx
 Minimum illuminance Emin : 0.0 lx
 Maximum illuminance Emax : 26 lx
 Uniformity Uo Emin/Em : ---
 Coefficient of Variation CV : 8.33

Appendix 2 – Reference Drawings





- 1. NOT BLACK FINISHED (BY AT TYPICAL FINISHES)
- 2. FINISHES TO BE DETERMINED BY THE ARCHITECT
- 3. ALUMINUM FINISHES TO BE DETERMINED BY THE ARCHITECT
- 4. ALUMINUM FINISHES TO BE DETERMINED BY THE ARCHITECT
- 5. ALUMINUM FINISHES TO BE DETERMINED BY THE ARCHITECT
- 6. ALUMINUM FINISHES TO BE DETERMINED BY THE ARCHITECT
- 7. ALUMINUM FINISHES TO BE DETERMINED BY THE ARCHITECT
- 8. ALUMINUM FINISHES TO BE DETERMINED BY THE ARCHITECT
- 9. ALUMINUM FINISHES TO BE DETERMINED BY THE ARCHITECT
- 10. ALUMINUM FINISHES TO BE DETERMINED BY THE ARCHITECT
- 11. ALUMINUM FINISHES TO BE DETERMINED BY THE ARCHITECT
- 12. ALUMINUM FINISHES TO BE DETERMINED BY THE ARCHITECT
- 13. ALUMINUM FINISHES TO BE DETERMINED BY THE ARCHITECT
- 14. ALUMINUM FINISHES TO BE DETERMINED BY THE ARCHITECT
- 15. ALUMINUM FINISHES TO BE DETERMINED BY THE ARCHITECT
- 16. ALUMINUM FINISHES TO BE DETERMINED BY THE ARCHITECT
- 17. ALUMINUM FINISHES TO BE DETERMINED BY THE ARCHITECT
- 18. ALUMINUM FINISHES TO BE DETERMINED BY THE ARCHITECT
- 19. ALUMINUM FINISHES TO BE DETERMINED BY THE ARCHITECT
- 20. ALUMINUM FINISHES TO BE DETERMINED BY THE ARCHITECT

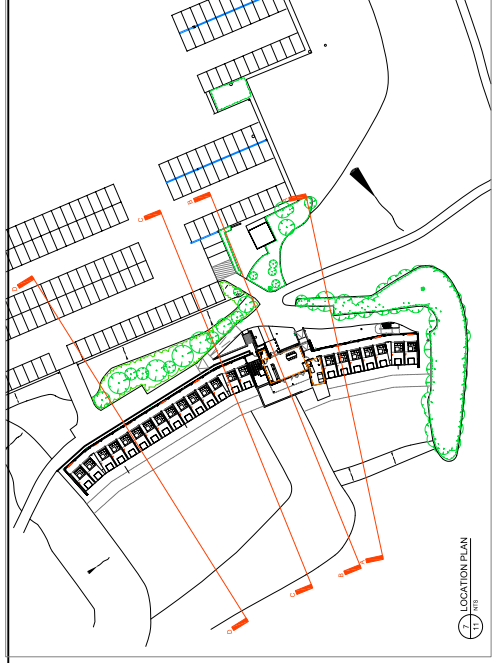

SECTION DD THROUGH UPPER LEVEL BAYS
SCALE 1:100

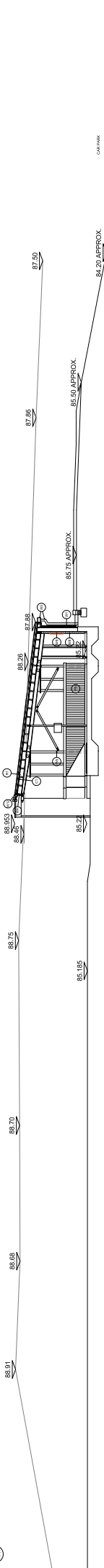

SECTION CC THROUGH UPPER LEVEL BAYS
SCALE 1:100

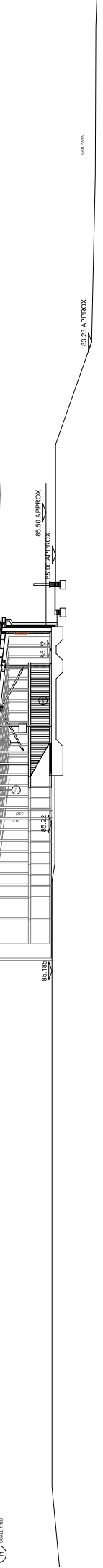

SECTION BB THROUGH RECEPTION
SCALE 1:100

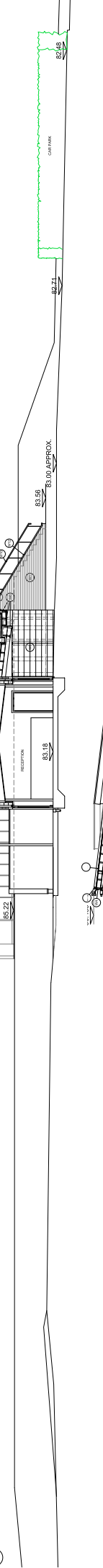

TYPICAL BAY SECTION AA
SCALE 1:100

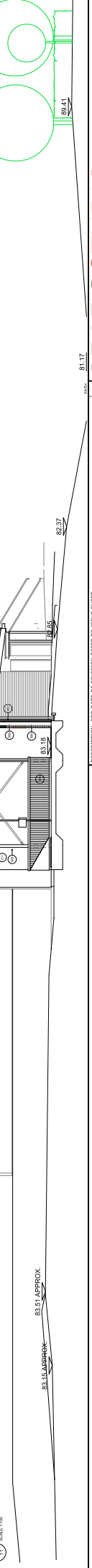

81.17

DESCRIPTION FOR DATE OF REVISION REFERS TO ISSUE SHEET

REV	7	
REV	6	

DISCREPANCY FOR DATE OF REVISION REFERS TO ISSUE SHEET

ASSOCIATED INFORMATION: THIS DRAWING IS TO BE READ IN CONJUNCTION WITH ALL RELATED AND ASSOCIATED DRAWINGS AND SPECIFICATIONS PRODUCED BY SPARCSTUDIO AND THE PROJECT CONSULTANT DESIGN TEAM. IT IS THE RESPONSIBILITY OF THE CONTRACTOR TO VERIFY ALL DIMENSIONS AND CONDITIONS BEFORE PROCEEDING WITH CONSTRUCTION. ANY DISCREPANCIES SHOULD BE REPORTED TO THE ARCHITECT IMMEDIATELY.

SW REFERENCES INDICATE SANITARYWARE ITEMS - REFER TO RELEVANT SANITARYWARE SCHEDULE FOR DETAILS.

SE SERVICES ACCESS: ACCESS TO SERVICES LOCATED IN CEILING VOIDS TO BE LIMITED WHEREVER POSSIBLE TO ALL LOCATIONS OF ACCESS. ACCESS HATCHES/PANELS IN FRONT OF HOSE AREAS TO BE SET-OUT & COORDINATED WITH REFLECTED CEILING & LIGHTING PLANS AND APPROVED PRIOR TO INSTALLATION.

SPARCSTUDIO DESIGN CONSULTANTS

CLIENT NAME: CLUB COMPANY

PROJECT NAME: WARWICKSHIRE TOPTRAGER GOLF

PROJECT NO: 3090

DATE: 17.12.21

STATUS: PLANNING

DRAWN BY: TH

CHECKED BY: TH

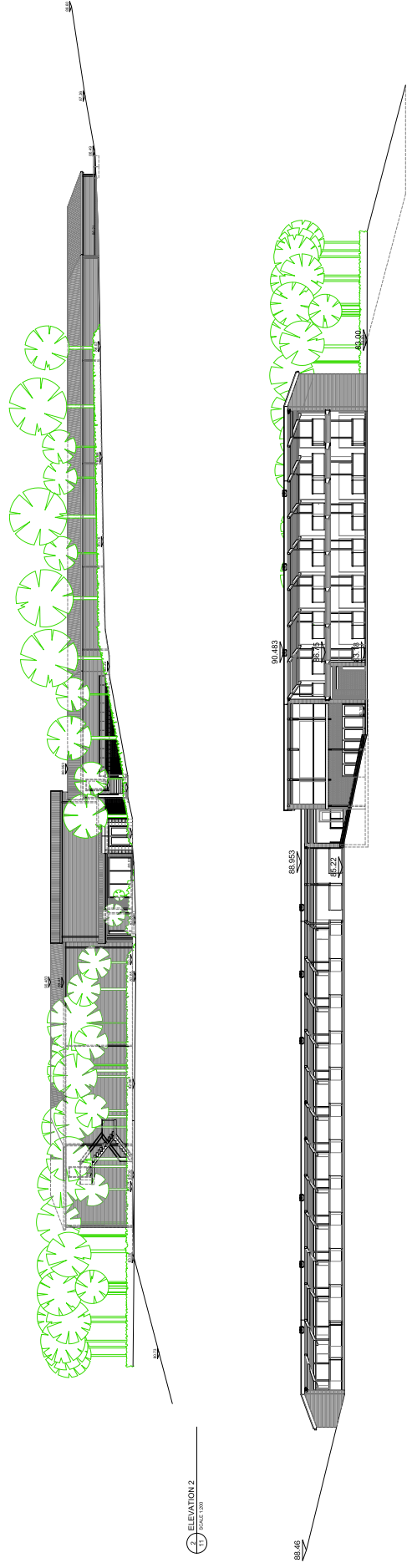
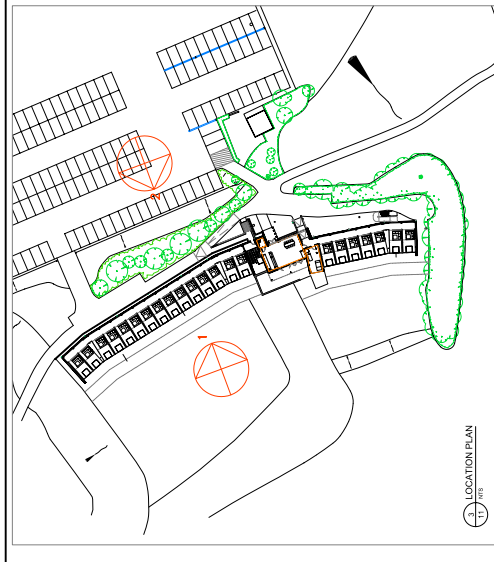

<p>DISCLAIMER: THIS DRAWING IS TO BE READ IN CONJUNCTION WITH ALL RELEVANT AND ASSOCIATED DRAWINGS AND SPECIFICATIONS PRODUCED BY SPARCSTUDIO AND THE PROJECT CONSULTANT DESIGN TEAM. THE CONTRACTOR SHALL BE RESPONSIBLE FOR VERIFYING ALL DIMENSIONS AND CONDITIONS FOR DETAILS. SPARCSTUDIO LTD ACCEPTS NO RESPONSIBILITY FOR ANY ERRORS OR OMISSIONS IN THIS DRAWING.</p> <p>CONTRACTOR'S RESPONSIBILITIES: IT IS THE CONTRACTOR'S RESPONSIBILITY TO CHECK THE ACCURACY AND BIDDABILITY OF THE DESIGN AND THE AVAILABILITY OF ALL MATERIALS IDENTIFIED IN THIS DRAWING IN A TIMELY MANNER. IN ORDER THAT RESPONSES TO ANY REQUESTS FOR INFORMATION ARE PROVIDED IN A TIMELY MANNER, THE CONTRACTOR SHALL BE RESPONSIBLE FOR PROVIDING ALL INFORMATION TO SPARCSTUDIO LTD AS EARLY AS POSSIBLE.</p> <p>CONTRACTOR'S RESPONSIBILITIES: IT IS THE CONTRACTOR'S RESPONSIBILITY TO CHECK THE ACCURACY AND BIDDABILITY OF THE DESIGN AND THE AVAILABILITY OF ALL MATERIALS IDENTIFIED IN THIS DRAWING IN A TIMELY MANNER. IN ORDER THAT RESPONSES TO ANY REQUESTS FOR INFORMATION ARE PROVIDED IN A TIMELY MANNER, THE CONTRACTOR SHALL BE RESPONSIBLE FOR PROVIDING ALL INFORMATION TO SPARCSTUDIO LTD AS EARLY AS POSSIBLE.</p> <p>CONTRACTOR'S RESPONSIBILITIES: IT IS THE CONTRACTOR'S RESPONSIBILITY TO CHECK THE ACCURACY AND BIDDABILITY OF THE DESIGN AND THE AVAILABILITY OF ALL MATERIALS IDENTIFIED IN THIS DRAWING IN A TIMELY MANNER. IN ORDER THAT RESPONSES TO ANY REQUESTS FOR INFORMATION ARE PROVIDED IN A TIMELY MANNER, THE CONTRACTOR SHALL BE RESPONSIBLE FOR PROVIDING ALL INFORMATION TO SPARCSTUDIO LTD AS EARLY AS POSSIBLE.</p>	<p>ASSOCIATED INFORMATION: THIS DRAWING IS TO BE READ IN CONJUNCTION WITH ALL RELEVANT AND ASSOCIATED DRAWINGS AND SPECIFICATIONS PRODUCED BY SPARCSTUDIO AND THE PROJECT CONSULTANT DESIGN TEAM. THE CONTRACTOR SHALL BE RESPONSIBLE FOR VERIFYING ALL DIMENSIONS AND CONDITIONS FOR DETAILS. SPARCSTUDIO LTD ACCEPTS NO RESPONSIBILITY FOR ANY ERRORS OR OMISSIONS IN THIS DRAWING.</p> <p>CONTRACTOR'S RESPONSIBILITIES: IT IS THE CONTRACTOR'S RESPONSIBILITY TO CHECK THE ACCURACY AND BIDDABILITY OF THE DESIGN AND THE AVAILABILITY OF ALL MATERIALS IDENTIFIED IN THIS DRAWING IN A TIMELY MANNER. IN ORDER THAT RESPONSES TO ANY REQUESTS FOR INFORMATION ARE PROVIDED IN A TIMELY MANNER, THE CONTRACTOR SHALL BE RESPONSIBLE FOR PROVIDING ALL INFORMATION TO SPARCSTUDIO LTD AS EARLY AS POSSIBLE.</p> <p>CONTRACTOR'S RESPONSIBILITIES: IT IS THE CONTRACTOR'S RESPONSIBILITY TO CHECK THE ACCURACY AND BIDDABILITY OF THE DESIGN AND THE AVAILABILITY OF ALL MATERIALS IDENTIFIED IN THIS DRAWING IN A TIMELY MANNER. IN ORDER THAT RESPONSES TO ANY REQUESTS FOR INFORMATION ARE PROVIDED IN A TIMELY MANNER, THE CONTRACTOR SHALL BE RESPONSIBLE FOR PROVIDING ALL INFORMATION TO SPARCSTUDIO LTD AS EARLY AS POSSIBLE.</p> <p>CONTRACTOR'S RESPONSIBILITIES: IT IS THE CONTRACTOR'S RESPONSIBILITY TO CHECK THE ACCURACY AND BIDDABILITY OF THE DESIGN AND THE AVAILABILITY OF ALL MATERIALS IDENTIFIED IN THIS DRAWING IN A TIMELY MANNER. IN ORDER THAT RESPONSES TO ANY REQUESTS FOR INFORMATION ARE PROVIDED IN A TIMELY MANNER, THE CONTRACTOR SHALL BE RESPONSIBLE FOR PROVIDING ALL INFORMATION TO SPARCSTUDIO LTD AS EARLY AS POSSIBLE.</p>
	<p>DESCRIPTION: FOR DATE OF REVISION REFER TO ISSUE SHEET</p>
<p>7</p>	<p>7</p>
<p>20 WATER LANE, 2ND FLOOR, LONDON, E14 3JH TEL: 020 7477 5977 EMAIL: STUDIO@SPARCSTUDIO.CO.UK</p>	<p>DATE DESIGNED: 16/12/21 DRAWN BY: TH CHECKED BY: ...</p>
<p>CLUB COMPANY GOLFERS CLUB PROPOSED DEVELOPMENT</p>	<p>STATUS: PLANNING</p>
<p>PROJECT NO: 3080 DRAWING NO: 11 SCALE: 1:200 @ A1</p>	<p>STATUS: PLANNING</p>
<p>SPARCSTUDIO DESIGN CONSULTANTS</p>	

KEY



Survey area boundary

Buildings and trees *



High bat roost potential



Low bat roost potential



Negligible bat roost potential

All other trees within the survey area are regarded as having negligible potential to support roosting bats.
*Roosting categories relate to roost potential in accordance with the BCT 2016 guidelines.

CLIENT:
The Club Company

PROJECT:
Warwickshire Golf & Country Club: Driving Range Bays

TITLE:
Phase 1 Bat Scoping Plan

SCALE AT A3:
NTS

DATE:
January 2022

XXX/01

Based on Ordnance Survey mapping with permission of Her Majesty's Stationery Office
Licence no. AR1873Z

© hankinson duckett associates
The Stables, Howbery Park, Benson Lane, Wallingford, OX10 8BA
t 01497 838775 e consult@hadenenviro.co.uk w www.hadenenviro.co.uk



Landscape Architecture
Masterplanning
Ecology



Appendix 3 - Product Data Sheets





**TOPTRACER
RANGE.**

Toptracer Range Installation Requirements

UK One System Installation



Data Network Cabling Requirements

Toptracer Power and Data Design Pack – Data Cable Requirements

Cable Types

1. Bay to server connections:

- Cat6 UTP External Grade Cable



Fig. 1 T568B-T568B

2. Camera to server connections:

- Cat6 UTP External Grade to cameras <100m from server,

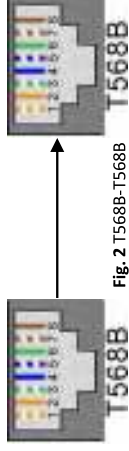

Fig. 2 T568B-T568B

Internet Connection Requirements

The Toptracer server requires an internet connection in order for us to perform remote support. This includes but is not limited to:

- Constant monitoring of the health of the system
 - Calibration of cameras if the cameras move
 - Software updates
 - Investigate and fix issues
- The internet connection that we get should be configured for DHCP through a standard RJ45 ethernet socket. No static external IP. No particular incoming ports need to be opened.

As long as this is achieved, we accept either a connection directly from your ISP or through a router that you manage. If the latter is the case it is important that no outgoing connections are blocked with firewalls etc.

Connection speed:

Minimum Requirements: 4Mbit/s Download – 2Mbit/s Upload
Recommended: 10Mbit/s Download – 10Mbit/s Upload

Data Terminations

- All Category 6 cable for bays to be run and terminated in accordance with **T568B** pinout [T568B-T568B] [Fig. 1].
- Camera to server connections to be terminated in accordance with **T568B** pinout [T568B-T568B] [Fig. 2]
- RJ45 modules for Bay screens and Cameras to be angled entry.
- RJ45 modules/outlets to be housed in IP65/66 rated enclosures.
- **Fluke Data Certification MUST be issued on completion of all data cabling**

Toptracer Power and Data Design Pack - Network Schematic Diagram

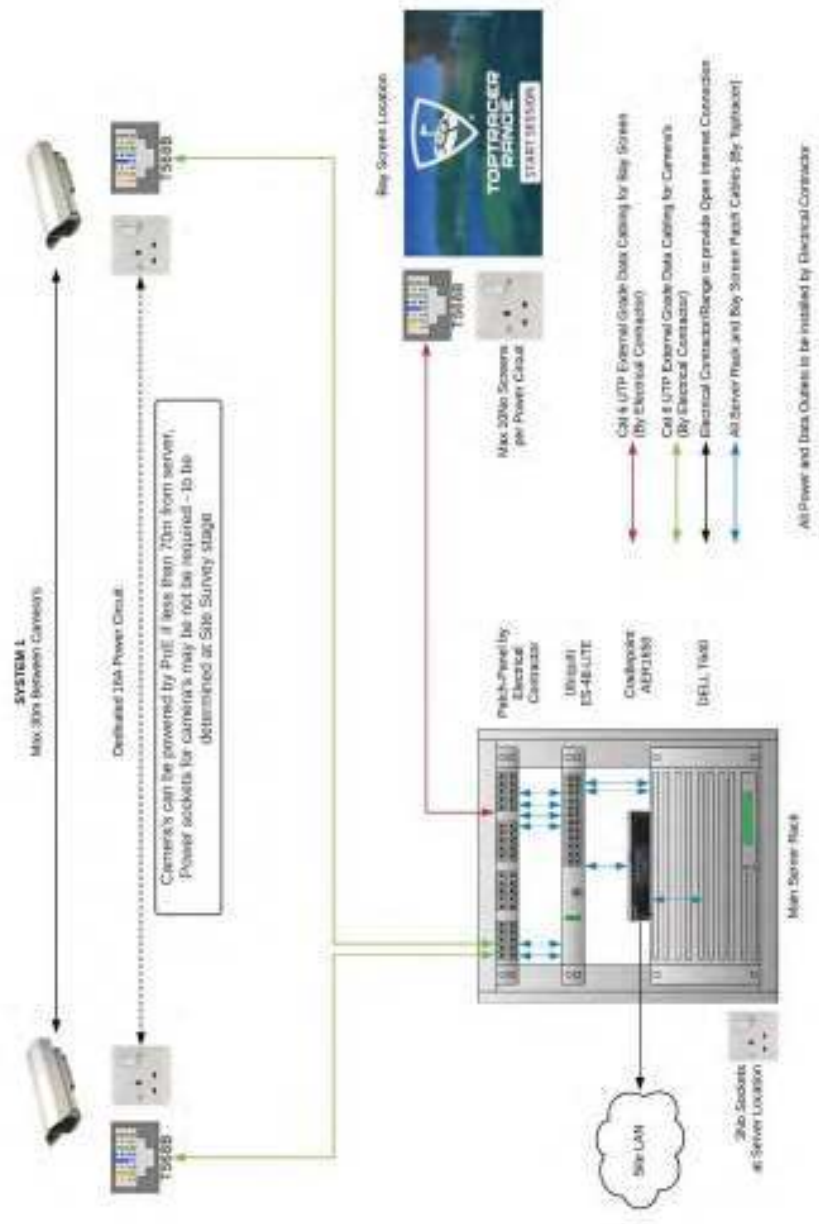



Preferred Electrical (Power) Installation

Toptracer Power and Data Design Pack – Power Requirements

Server

- Server room equipment requires a 16-amp minimum radial circuit.
- Server rack/enclosure will require on average, two double sockets – suggested installation of Power Distribution Unit (PDU) to meet requirement.
- **Safe working temperatures for the server which runs the Toptracer Range system are between 15-25° Celsius. The location in which the server is placed must be clean, dry ventilated and maintained between this temperature range.**

Cameras

- Dedicated 16-amp radial circuit (RCD) required for protection of external socket outlets.
- Enclosures for sockets to be IP65 rated.
- Each Camera *may* require one power socket (Camera power). This is dependent on the distance between camera and Toptracer switch (if less than 70m then camera's can be powered by PoE). **This will be decided after Site Survey.**

Bay Screens

- Dedicated radial circuit to power 10 bays at a time.
- Contactor and enclosure adjacent to Distribution Board.
- Contactor and all Bay Screen circuits to be controlled by a key switch as means of isolation for all bays (to be positioned within an office or where required by the site for ease of use).
- Switched fused-spur or switched socket to be installed for local isolation and termination of low volt supply transformers for the bay screens (to be enclosed within an IP65 enclosure, the screen mount, or other applications for suitable protection).

N.B. If the above is not possible, dedicated circuits to be wired to bay screens as per site restrictions – **as long as this maintains a separate radial circuit to the cameras.**

Containment

- Two compartment trunking is the preferred option for all cable containment.
- ***BOTH POWER AND DATA CABLES MUST BE KEPT SEPARATED THROUGHOUT THE ENTIRE INSTALLATION AS A MINIMUM REQUIREMENT*** this is to minimise the effect of any interference on data connections.

Certification/General

- Electrical Installation Certificate **MUST** be issued upon completion for all circuits.
- Toptracer personnel will complete a 'virtual' site visit up to two weeks prior to scheduled installation date in order to check and commission the power and data circuits.
- The Toptracer Equipment will need to be incorporated into your normal PAT Testing schedule
- All metalwork will need to be earthed in accordance with latest electrical requirements.

Toptracer Power and Data Design Pack – Power Schematic Diagram

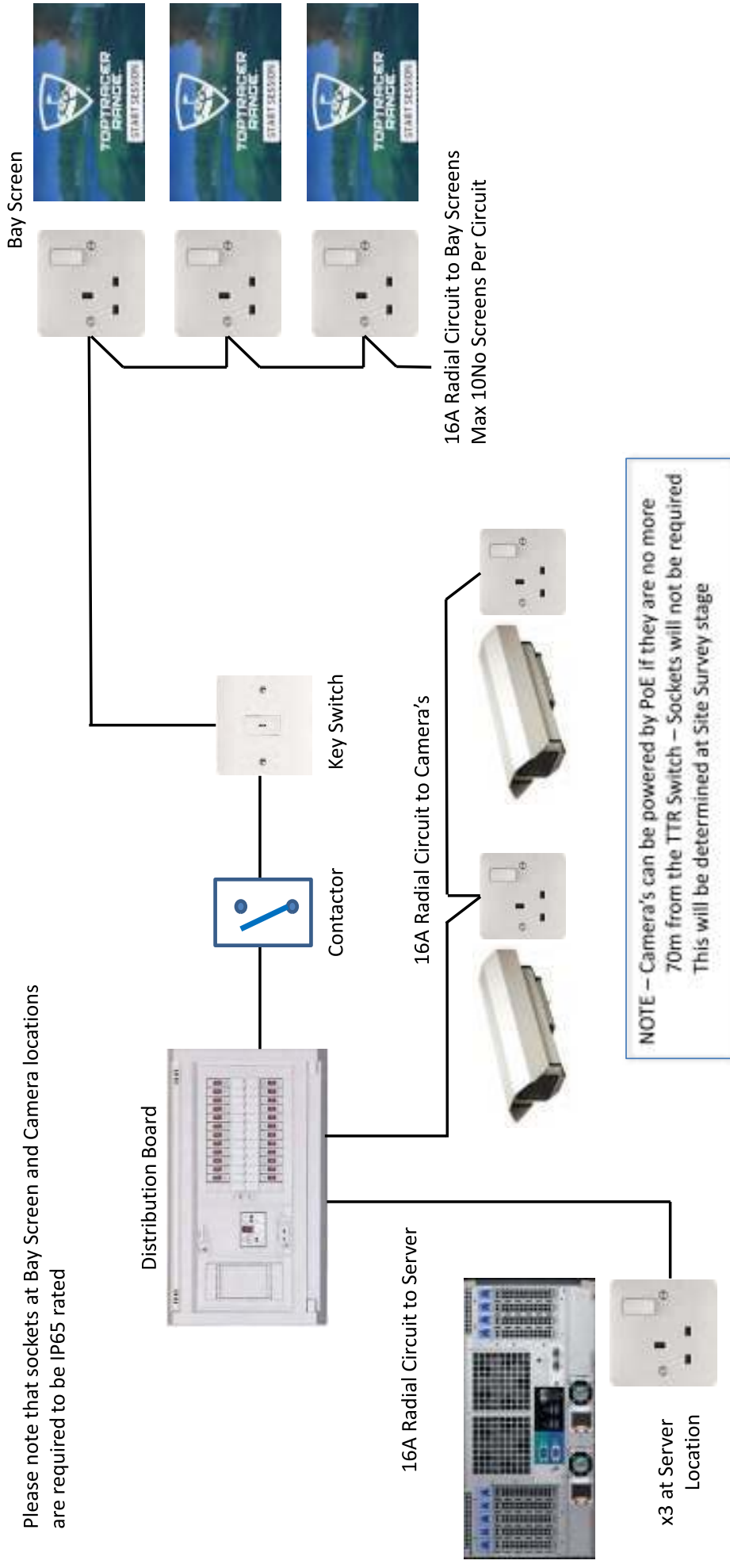



Camera Tracking Zone Layout

Toptracer Power and Data Design Pack – Camera Tracking Zone Layout

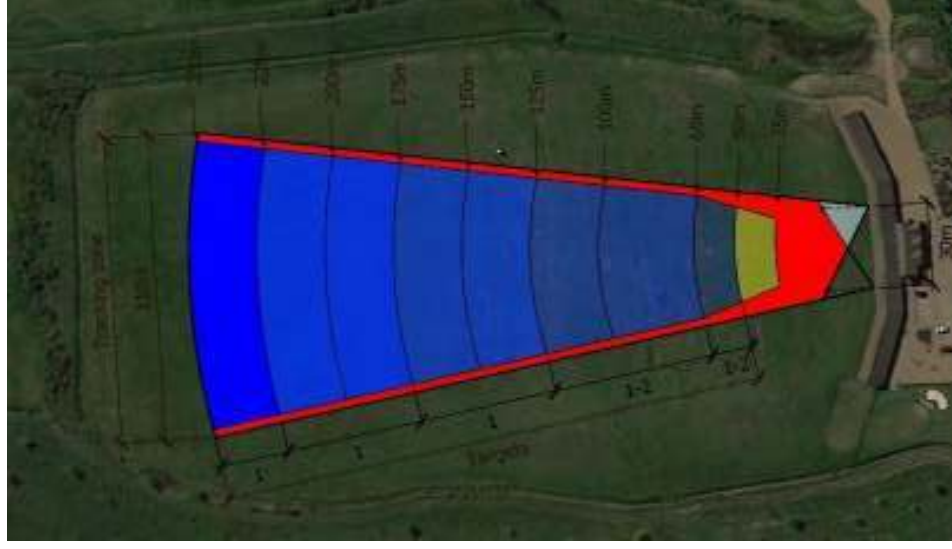

This diagram shows the vision areas of the cameras on a typical range

Red Zone

The red zone is an area where tracking cannot be guaranteed and therefore we recommend that no targets are install here

Yellow Zone

The yellow zone is an area where only 1 camera will see the ball flight at any given time. Targets should only be installed here if its is absolutely necessary or due to outfield restrictions.

Blue Zones

The blue zones are where both camera's will see the ball flight and therefore offer the best tracking. The majority of targets should be within these zones.

Further clarification on the location of targets can be sought from either the Solutions Architect or the Install Team.



Lighting Requirements

Toptracer Power and Data Design Pack – Lighting Requirements

Artificial Light

- The system requires artificial light to work properly outside of daylight hours. The artificial lighting should be illuminated at all times outside of full daylight conditions, including a short period before dusk and after dawn conditions to facilitate a smooth transition from daylight to night time operation or vice versa.
- It is a requirement that the light source comes from behind or in-line with the sensors in order for the light to reflect off the golf ball back to the sensor. However, the light source should never be closer than 5 meters horizontally and 2m vertically from the sensors. The light needs to be high enough to cover the entire ball flight of a shot.
- **The recommended level of lighting is such that the design achieves a wall of light at 50m from the bays up to 30m height. The light level recommended at this point is '3 foot candles' or '30 lux'. Please see diagrams for a representation of this lighting requirement.**

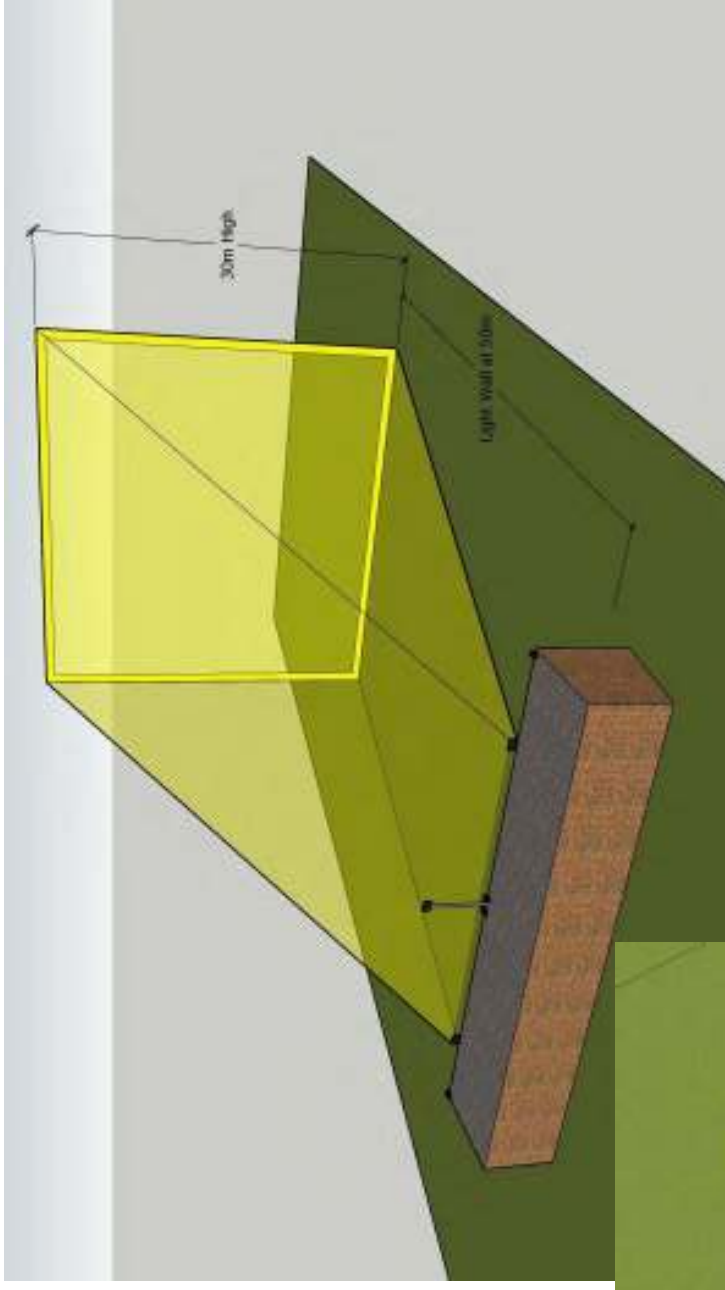

**Light source needs to come from behind, or in-line
With camera's to ensure light reflects off balls back to
camera**

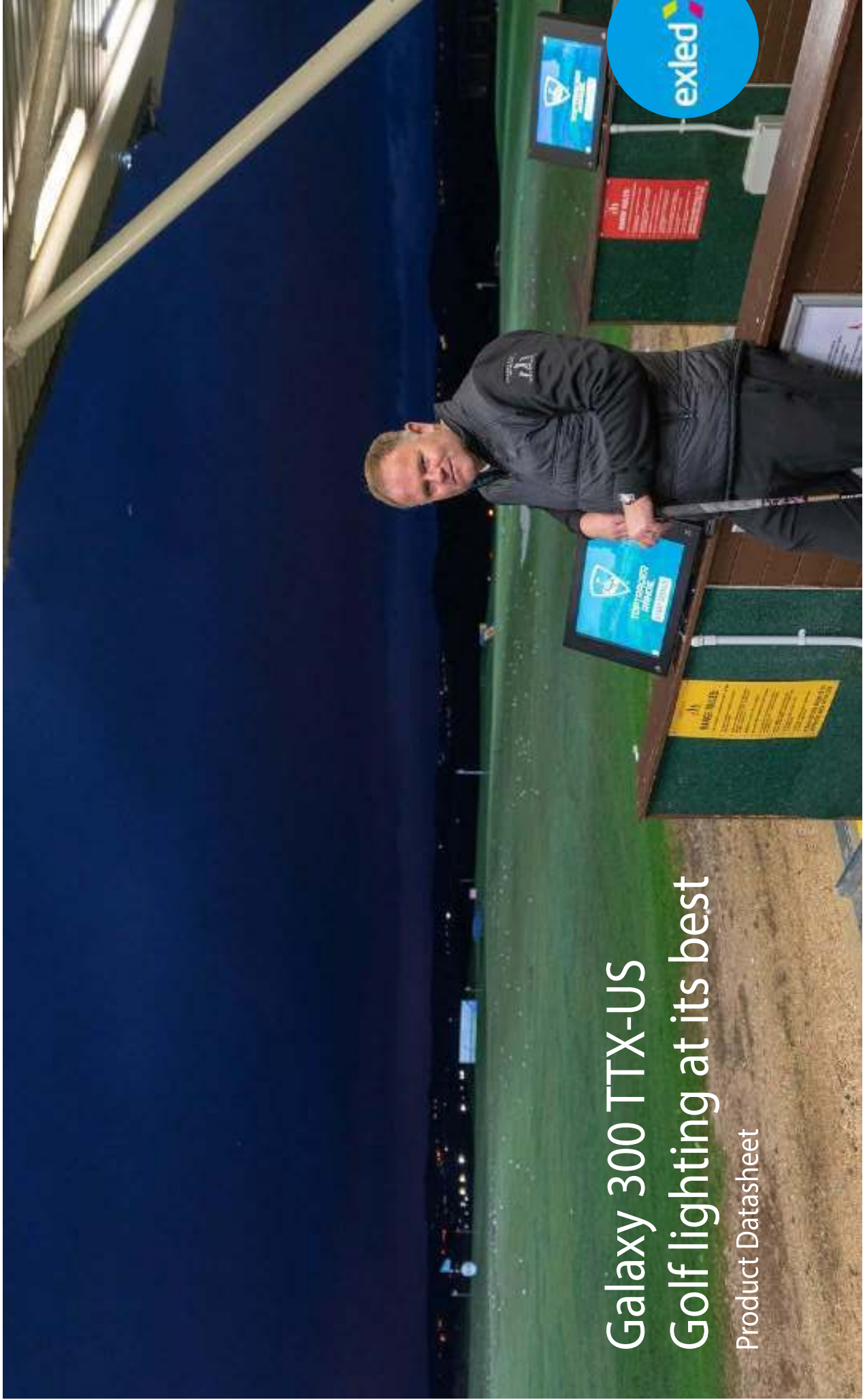

Galaxy 300 TTX-US Golf lighting at its best

Product Datasheet



DS_GALAXY-300-TTX

The Galaxy TTX range provides mid power LED ground mounted illumination specifically designed for golf outfield applications. Precise Optics, Top spec Philips or Osram LEDs for very high lumen efficiency, combined with excellent thermal management and a corrosion resistant coating, make the Galaxy range a class leading product.

Features:

- Latest LED and Optical Technology
- Design eliminates unwanted light spill
- Ideal for use in urban / residential areas
- Used by the leading venues
- Very long service life

5 year warranty

The Galaxy TTX is the latest generation high power LED luminaires with a circuit watt efficiency of +135 lumens per watt. The externally rated drivers can be remotely mounted if required.

Each of the lensed 100w modules can be aimed individually to give an exceptional light uniformity. Robust construction and corrosion proof coating make this fixture suitable for harsh weather climates.



For more information about the product featured in this datasheet please contact the experts at Exled. Call 01453 756 361, email sales@exled.co.uk or visit exled.co.uk

DS_GALAXY-300-TTX

Product Code	Galaxy 300 TTX
Power (Watts)	300
Lumen Output	36,600
Weight (KG)	9
Input Voltage	100-277VAC
LED Chip	Philips Lumileds / Osram
Dimmable Options	1-10v / Dali/Optional
Finish	Black or Grey Powder Coating
IP Rating	IP66
Beam Angles	10° / 25° / 30° / 45° / 60° / 90° / 120°
CCT	4000K / 5000K / 6500K
Warranty	5 Years



For more information about the product featured in this datasheet please contact the experts at Exled. Call 01453 756 361, email sales@exled.co.uk or visit exled.co.uk

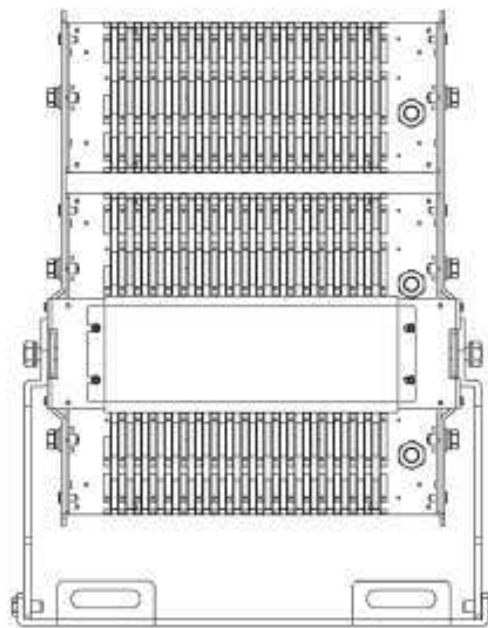
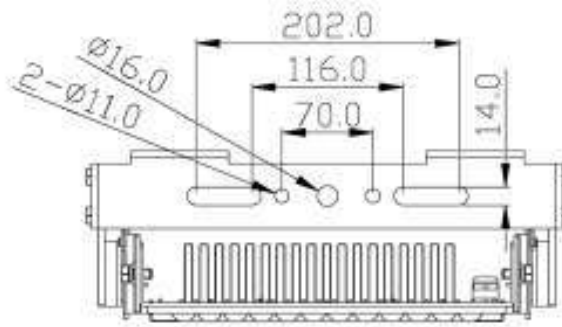
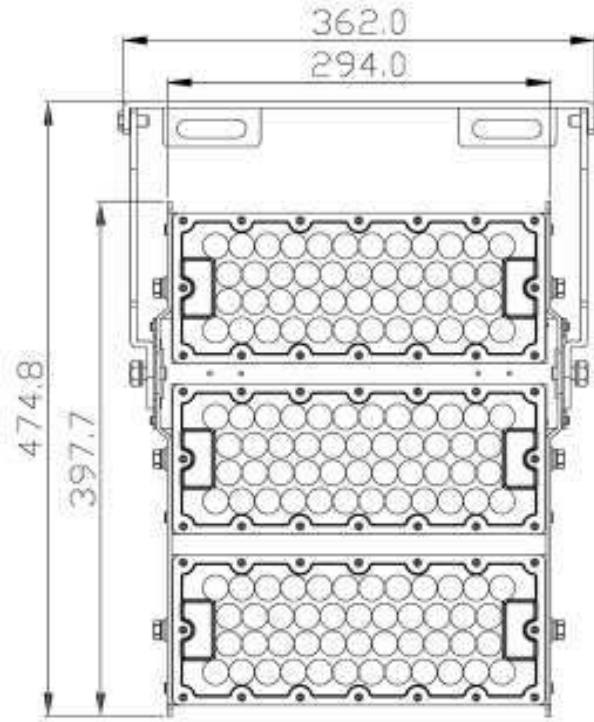



DS_GALAXY-300-TTX

Visit our website exled.co.uk



For more information about the product featured in this datasheet please contact the experts at Exled.

Call 01453 756 361 or email sales@exled.co.uk

Appendix 4 - Reference Guidance Notes





Guidance Note 08/18

Bats and artificial lighting in the UK

Bats and the Built Environment series



Copyright © 2018 ILP

All rights reserved. No part of this publication may be reproduced, stored in a retrieval system or transmitted in any form or by any means: electronic, electrostatic, magnetic tape, mechanical, photocopying, recording or otherwise, without permission in writing from the Institution of Lighting Professionals.

Institution of Lighting Professionals
Regent House
Regent Place
Rugby
Warwickshire
CV21 2PN

Tel: (01788) 576492
Email: info@theilp.org.uk
Website: www.theilp.org.uk

Registered Charity Number 268547

Bat Conservation Trust
Quadrant House
250 Kennington Lane
London
SE11 5RD

Tel: 0345 1300 228
Email: enquiries@bats.org.uk
Website: www.bats.org.uk

Registered charity in England and Wales
(1012361) and in Scotland (SC040116)

Contents

Acknowledgements	4
Glossary of technical terms	5
Chart of example lux levels for reference	6
1. Bats	7
General ecology	7
Legal protection of bats	7
Impacts from artificial lighting	8
Summary	10
2. Artificial lighting	11
Types of lights used in exterior lighting applications	11
Light source spectral ranges	11
Legal requirements for lighting	12
Lighting and the planning system	12
3. Mitigation of artificial lighting impacts on bats	14
Step 1: Determine whether bats could be present on site	14
Step 2: Determine the presence of – or potential for – roosts, commuting habitat and foraging habitat and evaluate their importance	16
Step 3: Avoid lighting on key habitats and features altogether	16
Step 4: Apply mitigation methods to reduce lighting to agreed limits in other sensitive locations – lighting design considerations	17
Step 5: Demonstrate compliance with lux limits and buffers	21
4. References	24

This document is aimed at lighting professionals, lighting designers, planning officers, developers, bat workers/ecologists and anyone specifying lighting. It is intended to raise awareness of the impacts of artificial lighting on bats, and mitigation is suggested for various scenarios. However it is not meant to replace site-specific ecological and lighting assessments.

This is a working document and as such the information contained has been updated in line with advances in our knowledge both into the impact on bats and also to reflect the advances in technology available in the lighting industry at the time of publication.

The information provided here is believed to be correct. However, no responsibility can be accepted by the Bat Conservation Trust, the Institution of Lighting Professionals or any of their partners or officers for any consequences of errors or omissions, nor responsibility for loss occasioned to any person acting or refraining from action as a result of information and no claims for compensation for damage or negligence will be accepted.

The use of proprietary and commercial trade names in this guidance does not necessarily imply endorsement of the product or relevant companies by the authors or publishers.

Acknowledgements

James Miles (Chair) – Kingfisher Lighting Ltd

Jo Ferguson (Chapter 1) – Bat Conservation Trust

Nick Smith (Chapter 2) – Nick Smith Associates Ltd

Harry Fox (Chapter 3) – Clarkson and Woods Ecological Consultants Ltd

The authors are grateful to the following people for their consultation during the preparation of this document:

Bonnie Brooks – Illume Design Ltd

Larry Burrows – Somerset County Council

Jan Collins – Bat Conservation Trust

Alison Fure – Furesfen Ecological Consultancy

Gregor Neeve – Natural England

Karen Renshaw – Bath and North East Somerset Council

Carol Williams – Bat Conservation Trust

Allan Howard – WSP

Charles Potterton (Illustrations) – Potterton Associates Ltd

Glossary of technical terms

Terms used in this document or that may be used by the lighting industry

Arc tube	A tube, normally ceramic or quartz, enclosed by the outer glass envelope of a high-intensity discharge lamp (HID) that contains the arc stream.
Asymmetric beams	Lamp is off-centre in a reflector more steeply curved at one end.
Calculation Plane	An even grid of points denoting the anticipated or modelled intensity (candelas) or illuminance (lux) levels at a given point.
Candela	The intensity of a light source in a specific direction. Unit of luminous intensity.
CMS – Central Management System	Is a specially developed software and service package that can efficiently handle all tasks of data collection and facility management. It allows users to remotely monitor and control lighting and apply dimming and/or switching controls.
Colour Rendering Index (CRI)	A scale from 0 to 100 percent indicating how accurate a given light source is at rendering colour when compared to a reference light source. The higher the number, the better a light source is at revealing the actual colours present at a surface or object.
Contrast	The relationship between the luminance of an object and its background. The higher the contrast the more likely it is an object can be seen.
Cowl	Physical light spill control accessory.
Diffuse	Term describing dispersed light distribution referring to the scattering of light.
Efficacy	A measure of light output against energy consumption measured in lumens per watt.
Glare	The sensation produced by luminances within the visual field that are sufficiently greater than the luminance to which the eyes are adapted, which causes annoyance, discomfort, or loss in visual performance and visibility.
Hood	Physical light spill control accessory.
Illuminance	Illuminance is the quantity of light, or luminous flux, falling on a unit area of a surface. It is sometimes designated by the symbol E. The unit is the lux (lx). Luminance refers to the light given off from a source while illuminance refers to the amount of light hitting a surface.
Lamp	Light source.
Light cone	The angle at which the beam falls off to 50% of peak intensity.
Light pollution	The spillage of light into areas where it is not required. Also known as obtrusive light.
Light spill	The light that falls outside the light cone.
Light trespass (nuisance)	Light that impacts on a surface outside of the area designed to be lit by a lighting installation. The correct legal term is nuisance.
Louvres	Physical light spill control accessory.

Lumen	The unit of light power emitted from a light source
Luminaire	Lighting enclosure, lantern, or unit designed to distribute light from a lamp or lamps.
Luminance	The physical measurement of the stimulus that produces the sensation of brightness measured by the luminous intensity reflected in a given direction. The unit is the candela per square metre (cd/m ²). Luminance refers to the light given off from a source while illuminance refers to the amount of light hitting a surface.
Lux (LX)	This is 'illuminance' or the quantity of light (luminous flux), falling on a unit area of a surface in the environment. It is sometimes designated by the symbol E.
Maintenance factor	A correction applied to a lighting calculation to allow for the build-up of dirt on a luminaire and the depreciation of the lumen output of a lamp over time. 1=100% output, 0.9=90% etc.
Optic	The components of a luminaire such as reflectors, refractors, and protectors which make up the directional light control section.
Photocell	A unit which senses light to control luminaires.
Reflector	A device used to reflect light in a given direction.
Refractor	A device used to redirect the light output from a lamp when the light passes through it. It is usually made from prismatic glass or plastic.
Shield	Physical light spill control accessory.
Sky glow	The brightening of the night sky caused by artificial lighting.
Symmetric beams	Lamp mounted in the centre of the reflector.
Voltage	The difference in electrical potential between two points of an electrical circuit.
Watt (W)	The unit for measuring electrical power.
Upward Light Output Ratio ULOR (%)	The proportion of direct light transmitted from the luminaire above 90° in the vertical plane

Chart of example lux levels for reference

Lighting conditions	Lux level	Lighting conditions	Lux level
British summer sunshine	50,000	Typical side road lighting	5
Overcast sky	5,000	Minimum security lighting	2
Well-lit office	500	Twilight	1
Minimum for easy reading	300	Clear full moon	0.25 to <1
Passageway or outside working area	50	Typical moonlight/cloudy sky	0.1
Good main road lighting	5-20	Typical starlight	0.001
Sunset	10	Poor starlight	0.0001

Source: IPCCTV specialists use-IP Ltd

1. Bats

General ecology

Bats are the only true flying mammals. Like us, they are warm-blooded, give birth to live young and produce milk for suckling. In Britain there are 18 species, all of which are small (most weigh less than a £1 coin) and eat insects.

Bats have developed a highly sophisticated echolocation system that allows them to avoid obstacles and catch these insects. When they're flying, bats produce a stream of high-pitched calls and listen to the echoes to produce a sound picture of their surroundings.

Some bats specialise in catching large insects such as beetles or moths but others eat large numbers of very small insects, such as gnats, midges and mosquitoes. Bats gather to feed wherever there are lots of insects, so the best places for them include traditional pasture, woodland, hedgerows, marshes, ponds and slow moving rivers.

During the winter there are relatively few insects available, so bats hibernate. They seek out appropriate sheltered roosts, let their body temperature drop to close to that of their surroundings and slow their heart rate to only a few beats per minute. This greatly reduces their energy requirements so that their food reserves last as long as possible.

During the spring and summer period female bats gather together into maternity colonies for a few weeks to give birth and rear their young (called pups). Usually only one pup is born each year. Bats may gather together from a large area to form these maternity roosts in warm and dry environments, so impacts at the summer breeding site can affect the whole colony of bats from a wide surrounding area.

Both winter and summer roosts have specific conditions that bats require at those times of the year and that is why bats are so faithful to their roosts. They are also an unusually long-lived mammal

with a slow reproductive rate for their size, meaning that they return year after year to roosts. If roosts are damaged or disturbed it takes a very long time for a population to recover.

For information on populations see <http://www.bats.org.uk>

Legal protection of bats

Due to the decline in bat numbers over the last century and the importance of specific roost requirements in their life cycle, all species of bat and their roost sites (whether bats are present at the time or not) are fully protected under international and domestic legislation. The international protection (the EC Habitats Directive) has been transposed into national laws by means of the Conservation of Habitats and Species Regulations 2017 (England and Wales), the Conservation (Natural Habitats, &c.) Regulations 1994 (as amended) (Scotland) and the Conservation (Natural Habitats, etc) Regulations (Northern Ireland) 1995 (as amended). Commonly the regulations are referred to as the Habitats Regulations. This makes it illegal to kill, injure, capture, or cause disturbance that affects populations of bats, obstruct access to bat roosts, or damage or destroy bat roosts. Individual bats are protected from 'intentional' or 'reckless' disturbance under the Wildlife and Countryside Act 1981 (as amended).

Lighting in the vicinity of a bat roost causing disturbance and potential abandonment of the roost could constitute an offence both to a population and to individuals (Garland and Markham, 2007). It is therefore important that the use of an area by bats is thoroughly assessed before artificial lighting is changed or added in the vicinity of a roost or where bats may commute or forage.

Natural England, Natural Resources Wales, Scottish Natural Heritage or Northern Ireland Environment Agency will need to

see that any impacts have been fully assessed and appropriate mitigation considered within any mitigation licence applications in relation to bats. Similarly these bodies will be statutory consultees in planning applications where impacts on Special Areas of Conservation (SACs), including those designated for bat conservation, are considered possible.

Local authorities also have a duty to ensure impacts upon legally protected species are avoided, and impacts upon bats are a material consideration in any planning permission. Furthermore, local authorities typically have specific planning policies ensuring that impacts upon wildlife, including bats, are avoided within development.

Impacts from artificial lighting

Studies have estimated that in 2016 more than 80% of the world population and more than 99% of the U.S. and European population live under light-polluted skies. Worldwide this is up from 66% in 2001, or an increase of more than 14% (Cinzano et al 2001); 'light-polluted skies' are defined as being about 10% higher than normal night sky brightness levels (Fabio et al 2016).

This means that only about a fifth of England now has 'pristine night skies' – that is skies 'completely free from light pollution' (CPRE 2016). Concerns about the impacts of this have been expressed for a long time, both in reference to human and ecosystem health (Gaston et al 2015).

For bats, artificial lighting is thought to increase the chances of predation, and therefore bats may modify their behaviour to respond to this threat (Speakman et al 1991, Jones et al 1994). Many avian predators will hunt bats which may be one reason why bats avoid flying in the day.

When we refer to artificial lighting we are referring to a number of different characteristics and types (see 'Artificial lighting' section below), all of which have varying impacts. For example, different

types of luminaire emit a different spectrum of light. The spectrum of light runs from short wave (ultraviolet) to long wave (infrared), and can vary in intensity (potentially causing glare) and illuminance (measured in lux). Definitions of technical terms can be found in the glossary.

Roosting and commuting

Illuminating a bat roost can cause disturbance (Downs et al 2003) and this may result in the bats deserting the roost or even becoming entombed within it (Packman et al 2015). Light falling on a roost access point will at least delay bats from emerging and this shortens the amount of time available to them for foraging (Boldogh et al 2007). As the main peak of nocturnal insect abundance occurs at and soon after dusk, a delay in emergence means this vital time for feeding is missed. This has been shown to have direct impacts on bats' reproductive ecology, such as slower growth rates and starvation of young (Duverge et al 2000).

In addition, the associated flightpath to and from the access point is just as valuable and vulnerable as the roost itself. Severing a key flightpath some distance from the roost could cause desertion in its own right.

Foraging

In addition to causing disturbance to bats at the roost, artificial lighting can also affect the feeding behaviour of bats. There are two aspects to this. One is the attraction that light from certain types of light sources has to a range of insects; the other is the presence of lit conditions posing a barrier to movement.

Many night-flying species of insect are attracted to light, especially those light sources that emit an ultraviolet component or have a high blue spectral content. This is particularly a problem if it is a single light source in a dark area. As well as moths (Wakefield et al 2015), a range of other insects can be attracted to light such as crane flies, midges and lacewings (Bruce-White et al 2011).

Studies have shown that noctule, Leisler's bat, serotine and pipistrelle bats can congregate around white mercury street lights (Rydell J et al 1993, Blake et al 1994) and white metal halide lamps (Stone et al 2015b) feeding on the insects attracted to the light, but this behaviour is not true for all bat species. The slower-flying broad winged species such as long-eared bats, *Myotis* species (which include Brandt's bat, whiskered, Daubenton's bat, Natterer's bat and Bechstein's bat), barbastelle, and greater and lesser horseshoe bats generally avoid all street lights (Stone et al 2009, 2012, 2015a). Consequently, bat species less tolerant of light are put at a competitive disadvantage and are less able to forage successfully and efficiently. This can have a significant impact upon fitness and breeding success.

The spectral impacts of light break down further still; when presented with lights with a range of colour types, it has been shown that *Plecotus* and *Myotis* species (slow flying) avoided white and green light lit areas, but *Pipistrellus* species (fast flying) were significantly more abundant feeding at these lights (Spoelstra et al 2015, 2017). However, both groups were equally abundant in the red light areas compared to the dark control, which may provide options for lighting when considering mitigation (see 'Mitigation' section below).

In addition it is thought that insects are attracted to lit areas from beyond the immediately illuminated habitat. This is thought to result in adjacent habitats supporting reduced numbers of insects, a 'vacuum effect'; population declines have been shown further afield, suggesting both direct and indirect impacts at play (Langevelde et al 2018). This is a further impact on the ability of the light-avoiding bats to be able to feed. It is noticeable that most of Britain's rarest bats are among those species listed as avoiding artificial light, so artificial lighting has potentially devastating conservation consequences for these species (Rowse et al 2016).

Drinking

The effects of artificial lighting on drinking resources for bats has been recorded to be stronger than on foraging. White light has been shown to stop slower-flying species drinking at cattle troughs, and even for faster-flying species drinking behaviour was reduced, however foraging behaviour increased as above (Russo et al 2017).

Commuting

When considering how bats move through the landscape, artificial lighting has been shown to be particularly harmful if used along river corridors, near woodland edges and near hedgerows. In mainland Europe, in areas where there are foraging or 'commuting' bats, stretches of road are left unlit or lighting is designed in such a way as to avoid bat colonies being cut off from their foraging grounds.

Studies have shown that continuous lighting in the landscape, such as along roads or waterways, creates barriers which many bat species cannot cross, especially the slower-flying species (Fure, A. 2012), even at very low light levels. Lesser horseshoe bats have been shown to move their flight paths which link their roosts and foraging grounds to avoid artificial light installed on their usual commuting route. Significant impacts have been recorded from as low as 3.6 lux (Stone et al 2012). Furthermore, the average light level on hedgerows most regularly used by this species has been recorded at 0.45 lux (Stone et al 2009).

Even bat species that have been shown to opportunistically forage in lit conditions (see above) have subsequently been recorded being impacted by artificial lighting. In our cities, for example, common pipistrelles – the UK's most numerous species – have been recorded avoiding gaps that are well lit, thereby creating a barrier effect (Hale et al 2015).

Migrating

Green light has been shown to not only impact upon foraging bats (see above) but also bats migrating through Europe.

Nathusius' and soprano pipistrelles have been shown to be attracted to green light from a distance further than their echolocation calls reach, indicating they are attracted to the light rather than insects (Voigt et al 2017). This demonstrates positive light attraction for this species meaning limiting UV is only part of the solution and indicates impacts from artificial light at night that aren't yet fully understood for migrating bats. This is especially true given that the most recent studies in this area suggest that red light also causes positive light responses for both of these bat species when they are migrating over and above warm-white light (Voigt et al 2018).

Summary

In summary, these impacts both alone and in combination are likely to have significant impacts for slower-flying, rarer species, and even for fast-flying species, potentially affecting reproductive, foraging and roosting opportunities. On a population and ecosystem level, impacts may affect the overall genetic pool of bat species and their prey species.

Consequently, if bats are suspected as being present on site ecological advice should be sought – and potentially survey data collected – in advance of any lighting design or fixing of scheme layout.

2. Artificial lighting

Types of lights used in exterior lighting applications

- 1. Low-pressure sodium lamps (SOX)** (orange lamps seen along roadsides). Light is emitted predominantly at one wavelength, contains no ultraviolet (UV) light, and has a low attraction to insects. The lamps tend to be large which makes it more difficult to focus the light from these lamps. These are in the gradual process of being removed or replaced, in part due to their poor colour rendition, and will not be available past 2019
- 2. High-pressure sodium lamps (SON)** (brighter pinkish-yellow lamps). Commonly used as road lighting. Light is emitted over a moderate band of long wavelengths giving little, if any, UV component, except for the version of the lamp used in horticulture. Insects are attracted to the brighter light. The lamp is of medium size and the light can be more easily directed than low pressure sodium. This lamp is still used for some main road lighting but this is being reduced; these lamps are expected to be phased out in the future.
- 3. Mercury lamps (MBF)** (bluish-white lamps). These emit light over a moderate spectrum, including a larger component of UV light to which insects are particularly sensitive. Insects are attracted in large numbers along with high densities of certain tolerant bat species (Rydell & Racey 1993). They ceased to be available in the EU in 2015 and are rare now.
- 4. White SON.** This is a reddish white light source. It is based on high-pressure sodium technology and has the same UV component as SON. This source is no longer used and is not available now.
- 5. Metal halide.** A small lamp and therefore more easy to focus light and make directional. Emits a small UV content. The light source is available in three forms a) quartz arc tube (HQI); b) ceramic arc tube (CDM-T) and c) CosmoPolis which is the newest of the ceramic forms. Still used by some for some exterior lighting applications.
- 6. Light emitting diodes (LEDs).** This is the light source of choice for most local authorities. The light emitted is more directional and normally controlled by lenses or sometimes reflectors. The light is produced in a narrow beam. It is an instant light source. LED is available in a number of colour temperatures. Older installations tend to use 'cool white' (blueish colour) at >5700° Kelvin. More recently, 4000°K has become more commonly used. 'Warm white' (more yellow/orange colour) at around 3000°K and as low as 2700°K can now be used with little reduction in lumen output. LED typically features no UV component and research indicates that while lower UV components attract fewer invertebrates, warmer colour temperatures with peak wavelengths greater than 550nm (~3000°K) cause less impacts on bats (Stone, 2012, 2015a, 2015b).
- 7. Tungsten halogen.** Is not used in new lighting schemes but may be encountered as security light on a private household.
- 8. Compact fluorescent.** Mostly in use in residential street lighting. It produces a white light; variants are available with

Light source spectral ranges

High pressure sodium	~390 to 800 nanometres (nm)
----------------------	-----------------------------

Tungsten Halogen	~400 to 800 nm
------------------	----------------

Metal Halide	~400 to 800 nm
--------------	----------------

LEDs	~410 to 750 nm
------	----------------

Compact fluorescent	~410 to 820 nm
---------------------	----------------

UV spectral ranges

UVA	315 to 400 nanometres (nm)
-----	----------------------------

UVb	280 to 315 nm
-----	---------------

UVc	100 to 280 nm
-----	---------------

minimal UV output. It can be used at a low wattage and therefore on a low output to achieve low levels of illuminance (measured in lux).

Legal requirements for lighting

It is important to remember that there is no legislation requiring an area or road to be lit.

The building regulations for domestic buildings specify that 150 watts is the maximum for exterior lighting of buildings but this does not apply to private individuals who install their own lighting.

There are a number of British Standards that relate to various components of lighting – BS5489 for road lighting, BS12164 for outdoor workplaces, BS12193 for sports lighting – and there are also guidelines that relate to crime prevention, prevention of vehicular accidents and amenity use.

BS5266-1:2011 relates to the design of emergency lighting and specifies that the minimum lighting level within an escape route from a building is 1 lux. While this represents an increase in lighting, because of the nature and infrequent use of emergency lighting (as most systems are non-maintained – off unless an emergency occurs) this should not pose an issue to bats.

Lighting and the planning system

Many county councils and less often district and borough councils set out standards in local guidance policy documents.

When a developer is assessing the need for lighting it would be beneficial to ask the local authority for their lighting policy document as this should incorporate all of the above. It is likely that local planning authorities will have policies outlining lighting standards for new roads or in public areas. However, local authorities also have a duty to ensure impacts upon legally protected species are avoided.

Roads, cycleways and footpaths to be adopted by a council highway authority may require some form of lighting. Some local authorities may only use columns and may not permit bollard lighting along footpaths or cycleways, or have certain illuminance standards to meet, therefore it is advisable to seek further specific information for your location. In addition to lighting on the application site the ecologist may also need to assess the effects of proposed illumination on habitat beyond the site boundary; for example, along roads and paths where proposed lighting connects to existing street lighting to cover access to the development and beyond. Surveys for lighting and bat activity to cover these areas may be required outside the proposed development's red line boundary.

Consequently, a judgement on the sensitivity of the particular bat feature or habitat on site and the perceived public need for lighting in proximity to it would need to be made. This would be done through collaborative discussion between the project ecologist, lighting professional and local authority (potentially involving one or more of the planning officer, ecology officer, highways officer or council lighting professional). This team can decide whether, where bat features or habitats are particularly important or sensitive, it may be appropriate to avoid, redesign or limit lighting accordingly. Such reasoned compromise decisions between protected species and public lighting, where it is justified to deviate from policy standards, are becoming increasingly accepted by local authorities. In addition, any unavoidable residual lighting may require further mitigation (alternative habitat creation, artificial barriers to lighting etc) over and above that for direct habitat loss. See 'Mitigation' section below for further information.

Domestic lighting needs no planning permission and depends on direct advice on the effects of lighting on bats being given to the householder. Lighting associated with new development or a

listed building does require planning permission.

When dealing with applications for the addition of artificial lighting planning officers or developers should ensure a lighting assessment is done alongside an ecological assessment. Full details on this process can be found in Mitigation section below.

Planning conditions requiring the detail of any domestic amenity and security lighting are regularly applied, as are those relating to the post-development monitoring of light levels against any modelled or baseline levels. This usually includes light trespass through windows in proximity to important bat habitat or roost features.

3. Mitigation of artificial lighting impacts on bats

This section provides a simple process which should be followed where the impact on bats is being considered as part of a proposed lighting scheme. It contains techniques which can be used on all sites, whether a small domestic project or larger mixed-use, commercial or infrastructure development. It also provides best-practice advice for the design of the lighting scheme for both lighting professionals and other users who may be less familiar with the terminology and theory.

The stepwise process and key follow-up actions are outlined in the flowchart overleaf, and are followed throughout the chapter.

The questions within this flow chart should be asked as early as possible, so that necessary bat survey information can be gathered in advance of any lighting design or fixing of overall scheme design.

Effective mitigation of lighting impacts on bats depends on close collaboration from the outset between multiple disciplines within a project. Depending on the specific challenges this will almost certainly involve ecologists working alongside architects and/or engineers; however, lighting professionals and landscape architects should be approached when recommended by your ecologist. This should be done as early in your project as possible in order to ensure mitigation is as effective as it can be and to minimise delays and unforeseen costs.

Step 1: Determine whether bats could be present on site

If your site has the potential to support bats or you are at all unsure, it is highly recommended that an ecologist is appointed to advise further and conduct surveys, if necessary. This information should be collected as early as possible in the design process, and certainly before lighting is designed, so as to avoid the need for costly revisions.

If any of the following habitats occur on site, and are adjacent to or connected with any of these habitats on or off site, it is possible that newly proposed lighting may impact local bat populations:

- Woodland or mature trees
- Hedgerows and scrub
- Ponds and lakes
- Ditches, streams, canals and rivers
- Infrequently managed grassland
- Buildings – pre 1970s or in disrepair

If you are unsure about whether bats may be impacted by your project, and an ecologist has not yet been consulted, sources of information on the presence of bats within the vicinity of your site include the following.

- Local environmental records centres (LERC) – Will provide third-party records of protected and notable species for a fee. Search <http://www.alerc.org.uk/> for more information.
- National Biodiversity Network Atlas – Provides a resource of third-party ecological records searchable online at <https://nbnatlas.org>. Typically this is less complete than LERC data. Please note: Some datasets are only accessible on a non-commercial basis, while most can be used for any purpose, as long as the original source is credited.
- Local authority planning portals – Most local planning authorities have a searchable online facility detailing recent planning applications. These may have been accompanied by ecological survey reports containing information on bat roosts and habitats.
- Defra's MAGIC map – Provides an online searchable GIS database including details of recent European protected species licences and details of any protected sites designated for bat conservation.

The professional directory at the website of the Chartered Institute of Ecology and Environmental Management (www.cieem.net) will provide details of ecologists in your area with the relevant

Step 1

Could bats be present on site?

Consult local sources of ecological information or seek advice from an ecologist

Step 2

Determine the presence of – or potential for – roosts, commuting habitat and foraging habitat and evaluate their importance.

Appoint ecologist to carry out daytime and, if necessary, night-time bat surveys and to evaluate the importance of the site's features and habitats to bats.

Step 3

Avoid lighting on key habitats and features altogether.

No illumination of any roost entrances and associated flightpaths, nor on habitats and features used by large numbers of bats, by rare species or by highly light-averse species.

Step 4

In other locations of value for bats on site, apply mitigation methods to reduce lighting to a minimum.

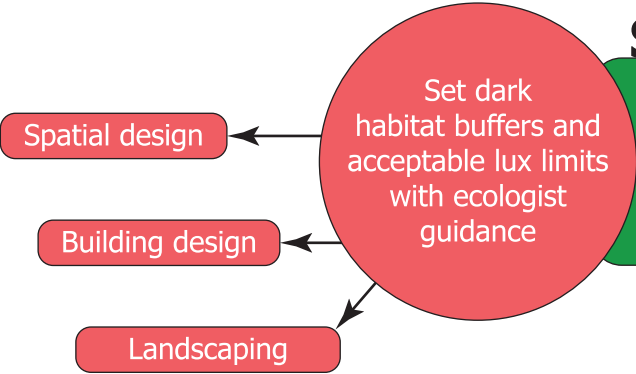

Step 5

Demonstrate compliance with lux limits and buffers.

Lighting professional to prepare final lighting scheme design and/or lux calculations or undertake baseline light surveys as necessary. Post-completion bat and lighting monitoring may be required.

skills/experience. The early involvement of a professional ecologist can minimise the likelihood of delays at the planning stage (if applicable) and ensure your project is compliant with conservation and planning legislation and policy.

It should be noted that the measures discussed in this document relate only to the specific impacts of lighting upon bat habitat features on or adjacent to the site. If loss or damage to roosting, foraging or commuting habitat is likely to be caused by other aspects of the development, separate ecological advice will be necessary in order to avoid, mitigate or compensate for this legally and according to the ecologist's evaluation.

Step 2: Determine the presence of – or potential for – roosts, commuting habitat and foraging habitat and evaluate their importance

Your ecologist will visit the site in order to record the habitats and features present and evaluate their potential importance to bats, and the likelihood that bats could be affected by lighting both on and immediately off site. This may also include daytime building and tree inspections. On the basis of these inspections further evening surveys may be recommended, either to determine the presence of roosts within buildings and/or trees or to assess the use of the habitats by bats by means of a walked survey. Such surveys may be undertaken at different times during the active season (ideally May to September) and should also involve the use of automated bat detectors left on site for a period of several days. The surveys should be carried out observing the recommendations within the Bat Conservation Trust's Bat Surveys for Professional Ecologists: Good Practice Guidelines (Collins, 2016).

The resulting report will detail the relative conservation importance of each habitat feature to bats (including built structures, if suitable). The ecologist's evaluation of the individual features will depend on the

specific combination of contributing factors about the site, including:

- The conservation status of species recorded or likely to be present
- Geographic location
- Type of bat activity likely (breeding, hibernating, night roosting, foraging etc)
- Habitat quality
- Habitat connectivity off-site
- The presence of nearby bat populations or protected sites for bats (usually identified in a desk study)

The evaluation of ecological importance for each feature is most commonly expressed on a geographic scale from Site level to International level, or alternatively in terms of that feature's role in maintaining the 'favourable conservation status' of the population of bats using it.

The ecologist should set out where any key bat roost features and/or habitat areas (ie flightpath habitat and broader areas of foraging habitat) lie on a plan of the site or as an ecological constraints and opportunities plan (ECOP) together with their relative importance. The ECOP and report can then be used to help guide the design of the lighting strategy as well as the wider project.

Step 3: Avoid lighting on key habitats and features altogether

As has been described in 'Artificial lighting', above, there is no legal duty requiring any place to be lit. British Standards and other policy documents allow for deviation from their own guidance where there are significant ecological/environmental reasons for doing so. It is acknowledged that in certain situations lighting is critical in maintaining safety, such as some industrial sites with 24-hour operation. However in the public realm, while lighting can increase the perception of safety and security, measureable benefits can be subjective. Consequently, lighting design should be flexible and be able to fully take into account the presence of protected species

and the obligation to avoid impacts on them.

Sources of lighting which can disturb bats are not limited to roadside or external security lighting, but can also include light spill via windows, permanent but sporadically operated lighting such as sports floodlighting, and in some cases car headlights. Additionally, glare (extremely high contrast between a source of light and the surrounding darkness – linked to the intensity of a luminaire) may affect bats over a greater distance than the target area directly illuminated by a luminaire and must also be considered on your site.

It is important that a competent lighting professional is involved in the design of proposals as soon as potential impacts (including from glare) are identified by the ecologist in order to avoid planning difficulties or late-stage design revision. Your lighting professional will be able to make recommendations about placement of luminaires tailored to your specific project.

Where highways lighting schemes are to be designed by the local planning authority (LPA) post-planning, an ecology officer should be consulted on the presence of important bat constraints which may impact the design and illuminance in order for the scheme to remain legally compliant with wildlife legislation.

Where adverse impacts upon the 'favourable conservation status' of the bat population using the feature or habitat would be significant, an absence of artificial illumination and glare, acting upon both the feature and an appropriately-sized buffer zone is likely to be the only acceptable solution. Your ecologist will be best placed to set the size of such a buffer zone but it should be sufficient to ensure that illumination and glare is avoided and so the input of a lighting professional may be required. Further information on demonstrating an absence of illumination via lux/illuminance contour plans is provided in Step 5.

Because different species vary in their response to light disturbance (as discussed in section 1 'Bats'), your ecologist will be able to provide advice tailored to the specific conditions on your project, however examples of where the no-lighting approach should be taken in particular include:

- Roosting and swarming sites for all species and their associated flightpath/commuting habitat.
- Foraging or commuting habitat for highly light-averse species (greater and lesser horseshoe bats, some *Myotis* bats, barbastelle bats and all long-eared bats).
- Foraging or commuting habitat used by large numbers of bats as assessed through survey.
- Foraging or commuting habitat for particularly rare species (grey long-eared bat, barbastelle, small *Myotis*, Bechstein's bat and horseshoe bats).
- Any habitat otherwise assessed by your ecologist as being of importance to maintaining the 'favourable conservation status' of the bat population using it.

Completely avoiding any lighting conflicts in the first place is advantageous because not only would proposals be automatically compliant with the relevant wildlife legislation and planning policy, but they could avoid costly and time-consuming additional surveys, mitigation and post-development monitoring. Furthermore, local planning authorities are likely to favour applications where steps have been taken to avoid such conflicts.

Step 4: Apply mitigation methods to reduce lighting to agreed limits in other sensitive locations – lighting design considerations

Where bat habitats and features are considered to be of lower importance or sensitivity to illumination, the need to provide lighting may outweigh the needs of bats. Consequently, a balance between a reduced lighting level appropriate to the

Example of illuminance limit zonation

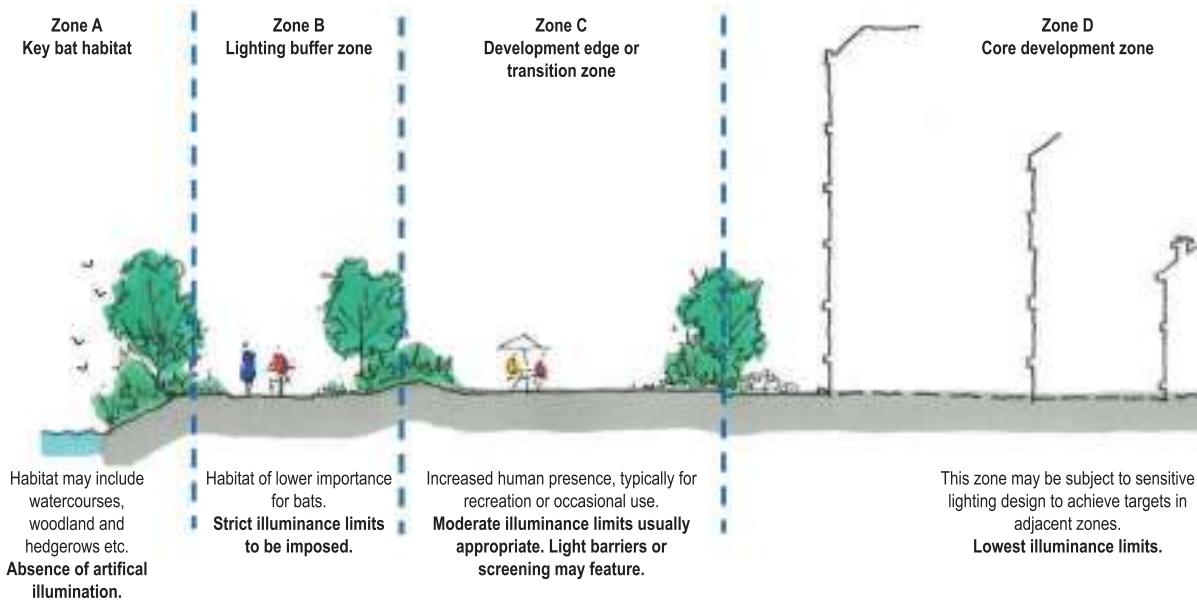

ecological importance of each feature and species, and the lighting objectives for that area will need to be achieved.

It is important to reiterate the legal protection from disturbance that bats receive under the Wildlife and Countryside Act 1981, as amended. Where the risk of offences originating from lighting is sufficiently high, it may be best to apply the avoidance approach in Step 3.

Advice from an ecologist and lighting professional will be essential in finding the right approach for your site according to their evaluation. The following are techniques which have been successfully used on projects and are often used in combination for best results.

Dark buffers, illuminance limits and zonation

Dark buffer zones can be used as a good way to separate habitats or features from lighting by forming a dark perimeter around them. Buffer zones rely on ensuring light levels (levels of illuminance measured in lux) within a certain distance of a feature do not exceed certain defined limits. The buffer zone can be further subdivided in to zones of increasing illuminance limit radiating away from the feature. Examples of this application are given in the figure above.

Your ecologist (in collaboration with a lighting professional) can help determine the most appropriate buffer widths and illuminance limits according to the value of that habitat to bats (as informed by species and numbers of bats, as well as the type of use).

Appropriate luminaire specifications

Luminaires come in a myriad of different styles, applications and specifications which a lighting professional can help to select. The following should be considered when choosing luminaires.

- All luminaires should lack UV elements when manufactured. Metal halide, fluorescent sources should not be used.
- LED luminaires should be used where possible due to their sharp cut-off, lower intensity, good colour rendition and dimming capability.
- A warm white spectrum (ideally <2700Kelvin) should be adopted to reduce blue light component.
- Luminaires should feature peak wavelengths higher than 550nm to avoid the component of light most disturbing to bats (Stone, 2012).
- Internal luminaires can be recessed where installed in proximity to windows to reduce glare and light spill. (See figure overleaf.)
- The use of specialist bollard or low-level downward directional luminaires to

retain darkness above can be considered. However, this often comes at a cost of unacceptable glare, poor illumination efficiency, a high upward light component and poor facial recognition, and their use should only be as directed by the lighting professional.

- Column heights should be carefully considered to minimise light spill.
- Only luminaires with an upward light ratio of 0% and with good optical control should be used – See ILP Guidance for the Reduction of Obtrusive Light.
- Luminaires should always be mounted on the horizontal, ie no upward tilt.
- Any external security lighting should be set on motion-sensors and short (1min) timers.
- As a last resort, accessories such as baffles, hoods or louvres can be used to reduce light spill and direct it only to where it is needed.

Sensitive site configuration

The location, orientation and height of newly built structures and hard standing can have a considerable impact on light spill (see figure above for examples of good internal lighting design). Small changes in terms of the placement of footpaths, open space and the number and size of windows can all achieve a good outcome in terms of minimising light spill on to key habitats and features.

- It may be possible to include key habitats and features into unlit public open space such as parks and gardens.
- Buildings, walls and hard landscaping may be sited and designed so as to block light spill from reaching habitats and features.

Internal lighting mitigation options

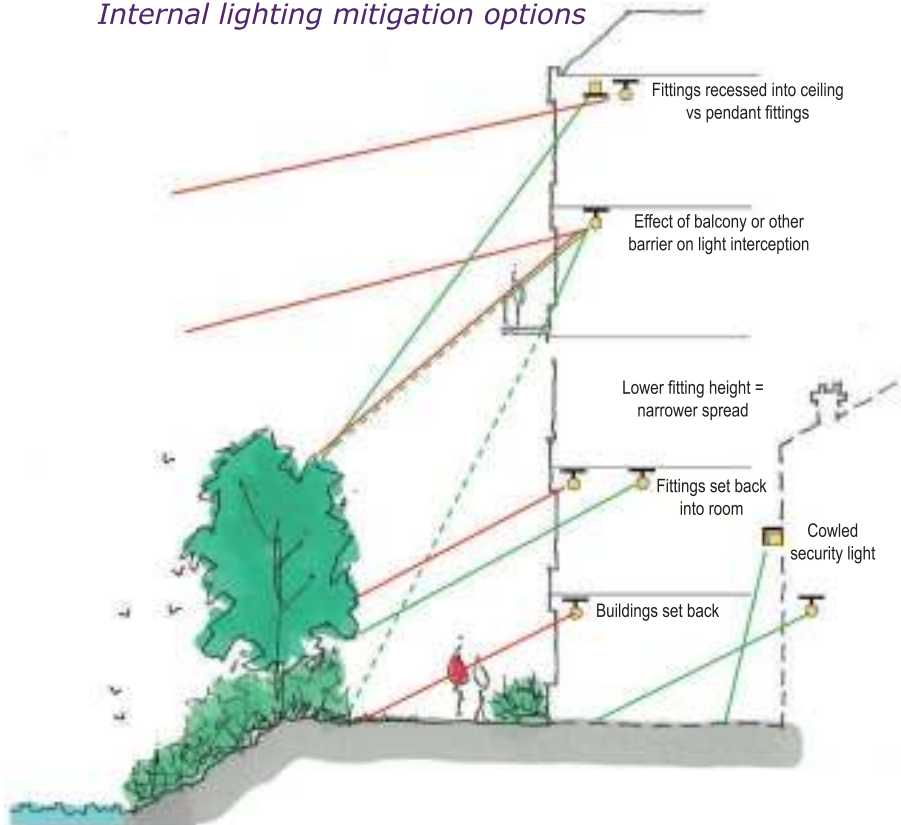

- Taller buildings may be best located toward the centre of the site or sufficiently set back from key habitats to minimise light spill.
- Street lights can be located so that the rear shields are adjacent to habitats or optics selected that stop back light thereby directing light into the task area where needed.

Screening

Light spill can be successfully screened through soft landscaping and the installation of walls, fences and bunding (see figure overleaf for example of physical light-screening options). In order to ensure that fencing makes a long-term contribution, it is recommended that it is supported on concrete or metal posts. Fencing can also be over planted with hedgerow species or climbing plants to soften its appearance and provide a vegetated feature which bats can use for navigation or foraging.

The planting of substantial landscape features integrated to the wider network of green corridors such as hedgerows, woodland and scrub is encouraged by

Examples of physical light screening options

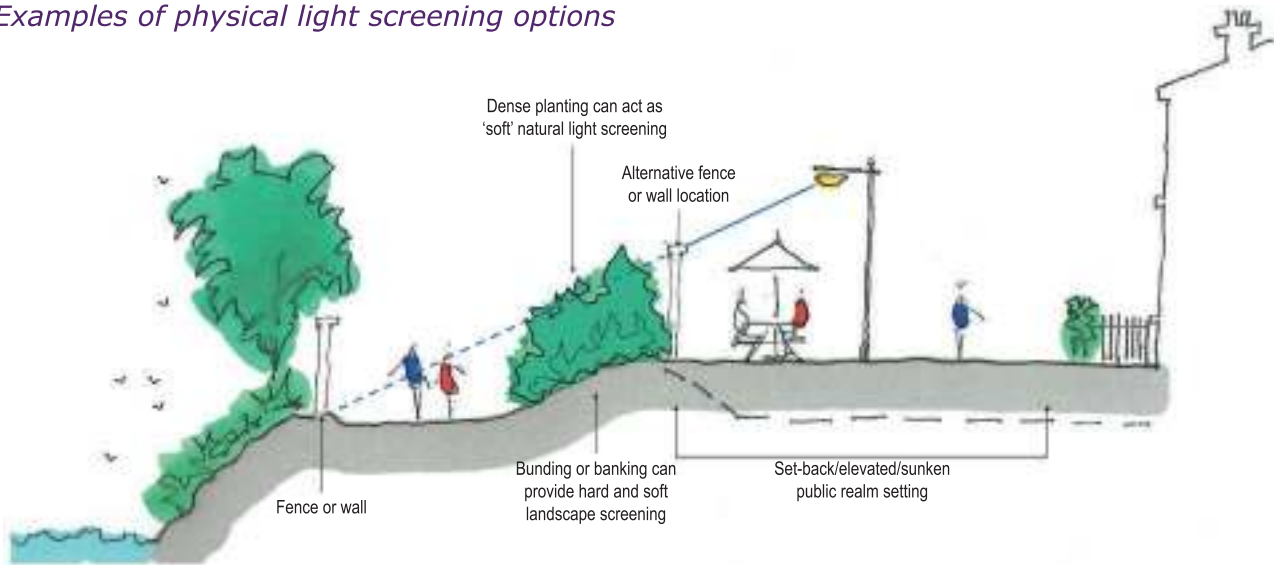

planning policy and would make a long-term positive contribution to the overall bat habitat connectivity and light attenuation. A landscape architect can be appointed to collaborate with your ecologist on maximising these natural light screening opportunities.

It should be noted that newly planted vegetation (trees, shrubs and scrub) is unlikely to adequately contribute to light attenuation on key habitats for a number of years until it is well established. Sufficient maintenance to achieve this is also likely to be required. Consequently, this approach is best suited to the planting of 'instant hedgerows' or other similarly dense or mature planting, including translocated vegetation. In some cases, it is appropriate to install temporary fencing or other barrier to provide the desired physical screening effects until the vegetation is determined to be sufficiently established.

Given the fact that planting may be removed, die back, or be inadequately replaced over time it should never be relied on as the sole means of attenuating light spill.

Glazing treatments

Glazing should be restricted or redesigned wherever the ecologist and lighting professional determine there is a likely significant effect upon key bat habitat and features. Where windows and glass

facades etc cannot be avoided, low transmission glazing treatments may be a suitable option in achieving reduced illuminance targets.

Products available include retrofit window films and factory-tinted glazing. 'Smart glass', which can be set to automatically obscure on a timer during the hours of darkness, and automatic blinds can also be used but their longevity depends on regular maintenance and successful routine operation by the occupant, and should not be solely relied upon.

Depending on the height of the building and windows, and therefore predicted light spill, such glazing treatments may not be required on all storeys. This effect can be more accurately determined by a lighting professional.

Creation of alternative valuable bat habitat on site

The provision of new, additional or alternative bat flightpaths, commuting habitat or foraging habitat could result in appropriate compensation for any such habitat being lost to the development. Your ecologist will be able to suggest and design such alternative habitats although particular consideration as to its connectivity to other features, the species to be used, the lag time required for a habitat to sufficiently establish, and the provision for its ongoing protection and maintenance should be given.

Dimming and part-night lighting

Depending on the pattern of bat activity across the key features identified on site by your ecologist, it may be appropriate for an element of on-site lighting to be controlled either diurnally, seasonally or according to human activity. A control management system can be used to dim (typically to 25% or less) or turn off groups of lights when not in use.

It should be noted that these systems depend on regular maintenance and a long-term commitment for them to be successful. Additionally, part-night lighting should be designed with input from an ecologist as they may still produce unacceptably high light levels when active or dimmed. Part-night lighting is not usually appropriate where lights are undimmed during key bat activity times as derived from bat survey data. Research has indicated that impacts upon commuting bats are still prevalent where lighting is dimmed during the middle of the night at a time when illumination for human use is less necessary (Azam et al, 2015). Thus this approach should not always be seen as a solution unless backed up by robust ecological survey and assessment of nightly bat activity.

Step 5: Demonstrate compliance with illuminance limits and buffers

Design and pre-planning phase

It may be necessary to demonstrate that the proposed lighting will comply with any agreed light-limitation or screening measures set as a result of your ecologist's recommendations and evaluation. This is especially likely to be requested if planning permission is required.

A horizontal illuminance contour plan can be prepared by a suitably experienced and competent lighting professional (member of the Chartered Institution of Building Services Engineers (CIBSE), Society of Light and Lighting (SLL), Institution of

Lighting Professionals (ILP) or similar to ensure competency) using an appropriate software package to model the extent of light spill from the proposed and, possibly, existing luminaires. The various buffer zone widths and illuminance limits which may have been agreed can then be overlaid to determine if any further mitigation is necessary. In some circumstances, a vertical illuminance contour plot may be necessary to demonstrate the light in sensitive areas such as entrances to roosts.

Such calculations and documentation would need to be prepared in advance of submission for planning permission to enable the LPA ecologist to fully assess impacts and compliance.

Because illuminance contour plots and plans may need to be understood and examined by non-lighting professionals such as architects and local planning authority ecologists, the following should be observed when producing or assessing illuminance contour plans to ensure the correct information is displayed.

- A horizontal calculation plane representing ground level should always be used.
- Vertical calculation planes should be used wherever appropriate, for example along the site-facing aspects of a hedgerow or façade of buildings containing roosts to show the illumination directly upon the vertical faces of the feature. Vertical planes can also show a cross-sectional view within open space. Vertical planes will enable a visualisation of the effects of illumination at the various heights at which different bat species fly.
- Models should include light from all luminaires and each should be set to the maximum output anticipated to be used in normal operation on site (ie no dimming where dimming is not anticipated during normal operation).
- A calculation showing output of luminaires to be expected at 'day 1' of operation should be included, where the luminaire and/or scheme Maintenance Factor is set to zero.

- Where dimming, PIR or variable illuminance states are to be used, an individual set of calculation results should accompany each of these states.
- The contours (and/or coloured numbers) for 0.2, 0.5, 1, 5, and 10 lux must be clearly shown as well as appropriate contours for values above these.
- Each contour plan should be accompanied by a table showing their minimum and maximum lux values.
- Where buildings are proposed in proximity to key features or habitats, plots should also model the contribution of light spill through nearby windows, making assumptions as to internal luminaire specification and transmissivity of windows. It should be assumed that blinds or curtains are absent or fully open although low-transmittance glazing treatments may be appropriate. Assumptions will need to be made as to the internal luminaire specification and levels of illuminance likely to occur on 'day 1' of operation. These assumptions should be clearly stated and guided by the building/room type and discussions between architect, client and lighting professional. It is acknowledged that in many circumstances, only a 'best effort' can be made in terms of accuracy of these calculations.
- Modelled plots should not include any light attenuation factor from new or existing planting due to the lag time between planting and establishment and the risk of damage, removal or failure of vegetation. This may result in difficulties in the long term achievement of the screening effect and hamper any post-construction compliance surveys.
- The illuminance contour plots should be accompanied by an explanatory note from the lighting professional to list where, in their opinion, sources of glare acting upon the key habitats and features may occur and what has been done/can be done to reduce their impacts.

N.B. It is acknowledged that, especially for vertical calculation planes, very low

levels of light (<0.5 lux) may occur even at considerable distances from the source if there is little intervening attenuation. It is therefore very difficult to demonstrate 'complete darkness' or a 'complete absence of illumination' on vertical planes where some form of lighting is proposed on site despite efforts to reduce them as far as possible and where horizontal plane illuminance levels are zero. Consequently, where 'complete darkness' on a feature or buffer is required, it may be appropriate to consider this to be where illuminance is below 0.2 lux on the horizontal plane and below 0.4 lux on the vertical plane. These figures are still lower than what may be expected on a moonlit night and are in line with research findings for the illuminance found at hedgerows used by lesser horseshoe bats, a species well known for its light averse behaviour (Stone, 2012).

Baseline and post-completion light monitoring surveys

Baseline, pre-development lighting surveys may be useful where existing on- or off-site lighting is suspected to be acting on key habitats and features and so may prevent the agreed or modelled illuminance limits being achieved. This data can then be used to help isolate which luminaires might need to be removed, where screening should be implemented or establish a new illuminance limit reduced below existing levels. For example, where baseline surveys establish that on- and off-site lighting illuminates potential key habitat, improvements could be made by installing a tall perimeter fence adjacent to the habitat and alterations to the siting and specification of new lighting to avoid further illumination. Further information and techniques to deal with modeling pre-development lighting can be found in ILP publication PLG04 *Lighting Impact Assessments* due to be published late 2018.

Baseline lighting surveys must be carried out by a suitably qualified competent person. As a minimum, readings should be

taken at ground level on the horizontal plane (to give illuminance hitting the ground), and in at least one direction on the vertical plane at, for example, 1.5m or 2m above ground (to replicate the likely location of bats using the feature or site). The orientation should be perpendicular to the dominant light sources or perpendicular to the surface/edge of the feature in question (such as a wall or hedgerow) in order to produce a 'worst case' reading. Further measurements at other orientations may prove beneficial in capturing influence of all luminaires in proximity to the feature or principal directions of flight used by bats. This should be discussed with the ecologist.

Baseline measurements should be taken systematically across the site or features in question. That is, they will need to be repeated at intervals to sample across the site or feature, either in a grid or linear transect as appropriate. The lighting professional will be able to recommend the most appropriate grid spacing.

Measurements should always be taken in the absence of moonlight, either on nights of a new moon or heavy cloud to avoid artificially raising the baseline. As an alternative, moonlight can be measured at a place where no artificial light is likely to affect the reading.

As all proposed illuminance level contours will be produced from modelled luminaires at 100% output, baseline measurements need to be taken with all lights on and undimmed, with blinds or screens over windows removed. Cowls and other fittings on luminaires can remain in place.

Where possible, measurements should be taken during the spring and summer when vegetation is mostly in leaf, in order to accurately represent the baseline during

the principal active season for bats and to avoid artificially raising the baseline.

The topography of the immediate surrounding landscape should be considered in order to determine the potential for increased or decreased light spill beyond the site.

Post-construction/operational phase compliance-checking

Post-completion lighting surveys are often required where planning permission has been obtained on the condition that the proposed lighting levels are checked to confirm they are in fact achieved on site and that the lighting specification (including luminaire heights, design and presence of shielding etc) is as proposed.

All lighting surveys should be conducted by a suitably qualified competent person and should be conducted using the same measurement criteria and lighting states used in the preparation of the illuminance contour plots and/or baseline surveys as discussed above. It may be necessary to conduct multiple repeats over different illumination states or other conditions specific to the project.

Results should always be reported to the LPA as per any such planning condition. A report should be prepared in order to provide an assessment of compliance by the lighting professional and a discussion of any remedial measures which are likely to be required in order to achieve compliance. Any limitations or notable conditions such as deviation from the desired lighting state or use of blinds/barriers should be clearly reported. Ongoing monitoring schedules can also be set, especially where compliance is contingent on automated lighting and dimming systems or on physical screening solutions.

4. References

- Azam, C., Kerbiriou, C., Vernet, A., Julien, J.F., Bas, Y., Plichard, L., Maratrat, J., Le Viol, I. (2015). Is part-night lighting an effective measure to limit the impacts of artificial lighting on bats? *Global Change Biology* 21:4333–4341.
- Bat Conservation Trust. (2009). Bats and lighting in the UK- bats and the built environment series www.bats.org.uk
- Blake, D., Hutson, A.M., Racey, P.A., Rydell, J., Speakman, J.R. (1994). Use of lamplit roads by foraging bats in southern England. *J. Zool.* 234, 453–462.
- Bruce-White, C. and Shardlow, M. (2011). A Review of the Impact of Artificial Light on Invertebrates. Buglife.
- Boldogh, S., D. Dobrosi & P. Samu 2007. The effects of the illumination of buildings on house-dwelling bats and its conservation consequences. *Acta Chiropterologica* 9, 527–534.
- Campaign to Protect Rural England. (2016). Night Blight: Mapping England's light pollution and dark skies.
- Cinzano, P., Falchi, F. and Elvidge, C. D. (2001). The first World Atlas of the artificial night sky brightness. *Monthly notices of the Royal astronomical society.* 328, pp. 689-707.
- Downs, N. C. et al (2003) The effects of illuminating the roost entrance on the emergence behaviour of *Pipistrellus pygmaeus*. *Biological Conservation* 111, 247-252
- Duvergé, P. L., G. Jones, J. Rydell & R. D. Ransome (2000). The functional significance of emergence timing in bats. *Ecography* 23, 32-40.
- Fabio Falchi, Pierantonio Cinzano, Dan Duriscoe, Christopher C. M. Kyba, Christopher D. Elvidge, Kimberly Baugh, Boris A. Portnov, Nataliya A. Rybnikova and Riccardo Furgoni. (2016). The new world atlas of artificial night sky brightness. *Sci. Adv.* 2016; 2 : e1600377
- Fure, A (2012) Bats and Lighting – six years on. *The London Naturalist* No. 85
- Garland L & Markham, S. (2007) Is important bat foraging and commuting habitat legally protected? (self published)
- Gaston KJ, Visser ME, Hölker F. (2015) The biological impacts of artificial light at night: the research challenge. *Philosophical Transactions of the Royal Society B: Biological Sciences.* 2015;370(1667):20140133. doi:10.1098/rstb.2014.0133.
- Institution of Lighting Engineers (2011) Guidance Notes for the Reduction of Obstructive Light
- James D. Hale, Alison J. Fairbrass, Thomas J. Matthews, Gemma Davies, Jon P. Sadler. (2015) The ecological impact of city lighting scenarios: exploring gap crossing thresholds for urban bats. *Global Change Biology*, 2015; DOI: 10.1111/gcb.12884
- Jones, G., Rydell, J. (1994). Foraging strategy and predation risk as factors influencing emergence time in echolocating bats. *Philos. T. R. Soc. B.* 346, 445–455.
- Frank van Langevelde, Marijke Braamburg-Annegarn, Martinus E. Huigens, Rob Groendijk, Olivier Poitevin, Jurriën R. van Deijk, Willem N. Ellis, Roy H.A. van Grunsven, Rob de Vos, Rutger A. Vos, Markus Franzén and Michiel F. WallisDeVries (2017) Declines in moth populations stress the need for conserving dark nights. *Global Change Biology* DOI: 10.1111/gcb.14008
- Mitchell-Jones, A. J. (2004) Bat Mitigation Guidelines. *English Nature*
- Packman, C., Zeale, M., Harris, S. & Jones, G. (2015). Management of bats in churches – a pilot. *English Heritage Research Project*: 6199.
- Rich, C., Longcore, T. (2006). *Ecological consequences of artificial night lighting.* Washington, DC, USA. Island Press.

- Rowse, E. G., D. Lewanzik, E. L. Stone, S. Harris, and G. Jones (2016). Dark Matters : The Effects of Artificial Lighting on Bats. In: *Bats in the Anthropocene: conservation of bats in a changing world* (C. C. Voigt and T. Kingston, Eds.).
- Russo, D., Cistrone, L., Libralato, N., Korine, C., Jones, G. and Ancillotto, L. (2017), Adverse effects of artificial illumination on bat drinking activity. *Anim Conserv.* doi:10.1111/acv.12340
- Rydell J & Racey, P A (1993) Street lamps and the feeding ecology of insectivorous bats. *Recent Advances in Bat Biology Zool Soc Lond Symposium abstracts.*
- Speakman, J. R. (1991). Why do insectivorous bats in Britain not fly in daylight more frequently? *Funct. Ecol.* 5, 518-524.
- Spoelstra, K., van Grunsven, R.H.A., Donners, M., et al (2015). Experimental illumination of natural habitat—an experimental set-up to assess the direct and indirect ecological consequences of artificial light of different spectral composition. *Philos. T. R. Soc. B.* 370, 20140129.
<http://dx.doi.org/10.1098/rstb.2014.0129>.
- Spoelstra K, van Grunsven RHA, Ramakers JJC, Ferguson KB, Raap T, Donners M, Veenendaal M, Visser ME. (2017) Response of bats to light with different spectra: light-shy and agile bat presence is affected by white and green, but not red light. *Proc. R. Soc. B* 284: 20170075.
<http://dx.doi.org/10.1098/rspb.2017.0075>
- Stone, E.L., Jones, G., Harris, S. (2009). Street lighting disturbs commuting bats. *Curr. Biol.* 19, 1123–1127.
- Stone, E.L., Jones, G., Harris, S. (2012). Conserving energy at a cost to biodiversity? Impacts of LED lighting on bats. *Glob. Change Biol.* 18, 2458–2465.
- Stone, E.L., Harris, S., Jones, G. (2015a). Impacts of artificial lighting on bats: A review of challenges and solutions. *Mammal. Biol.* 80, 213-219.
- Stone, E.L., Wakefield, A., Harris, S., Jones, G. (2015b). The impacts of new street light technologies: experimentally testing the effects on bats of changing from low-pressure sodium to white metal halide. *Philos. T. R. Soc. B.* 370, 20140127.
- Voigt CC, Roeleke M, Marggraf L, Pētersons G, Voigt-Heucke SL (2017) Migratory bats respond to artificial green light with positive phototaxis. *PLoS ONE* 12(5): e0177748.
- Voigt CC, Rehnig K, Lindecke O, Pētersons G. (2018) Migratory bats are attracted by red light but not by warm-white light: Implications for the protection of nocturnal migrants. *Ecology and Evolution.*
- Wakefield, A., Stone, E.L., Jones, G., Harris, S. (2015). Light-emitting diode street lights reduce last-ditch evasive manoeuvres by moths to bat echolocation calls. *R. Soc. Open Sci.* 2, 150291.
<http://dx.doi.org/10.1098/rsos.150291>.