

### Existing Workshop

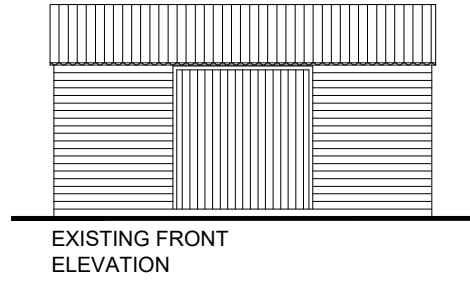

EXISTING FRONT ELEVATION

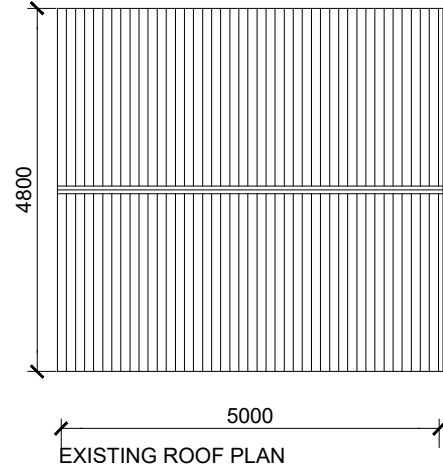
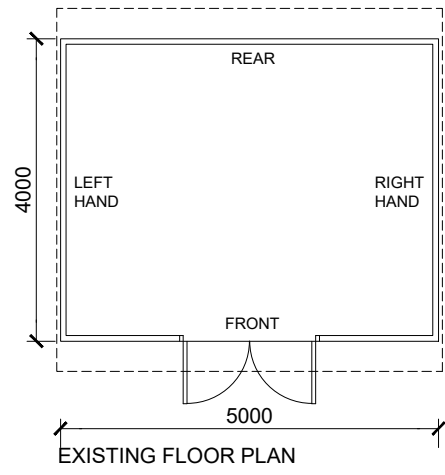
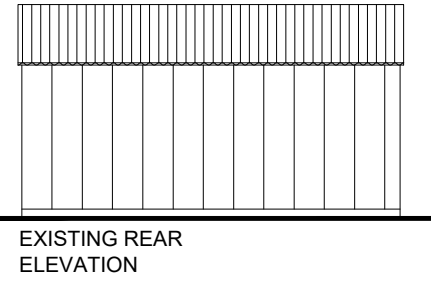

EXISTING REAR ELEVATION

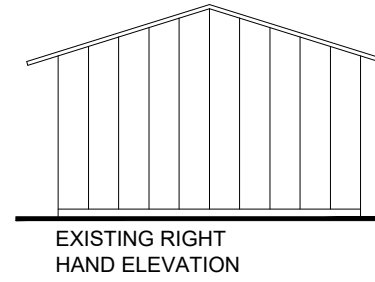

EXISTING RIGHT HAND ELEVATION

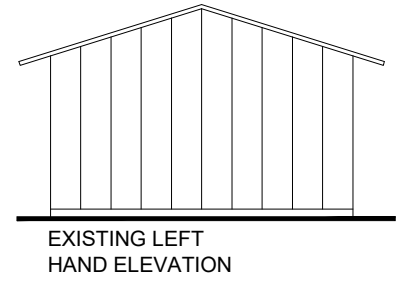

EXISTING LEFT HAND ELEVATION

### Proposed Workshop

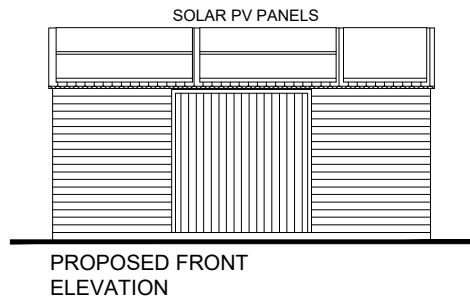
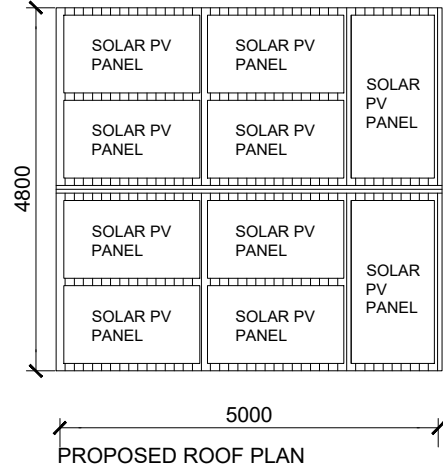
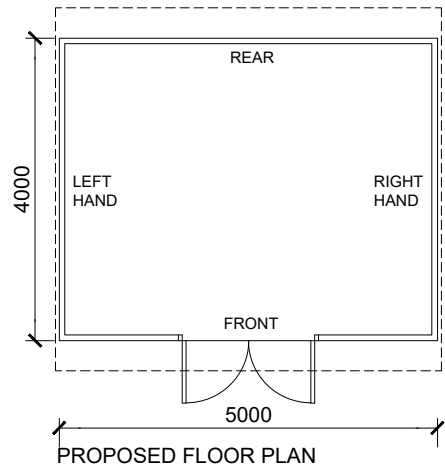

PROPOSED FRONT ELEVATION

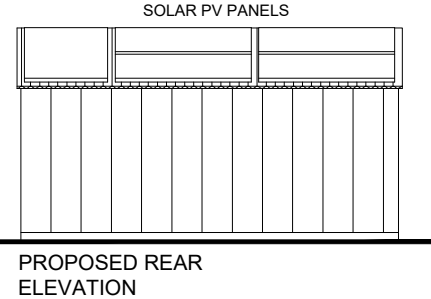

PROPOSED REAR ELEVATION

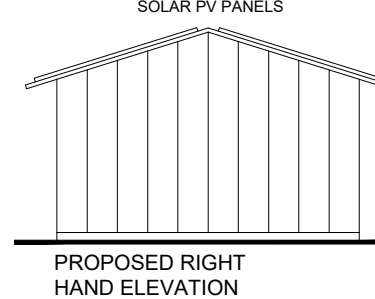

PROPOSED RIGHT HAND ELEVATION

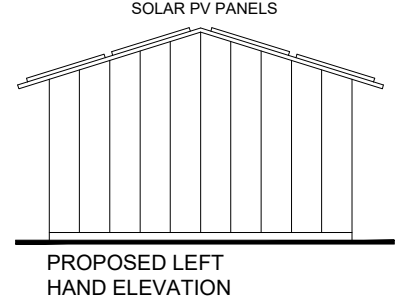

PROPOSED LEFT HAND ELEVATION

### Existing Sun House

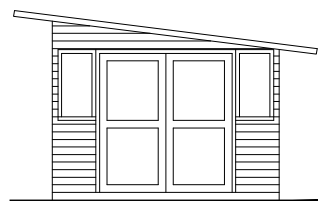
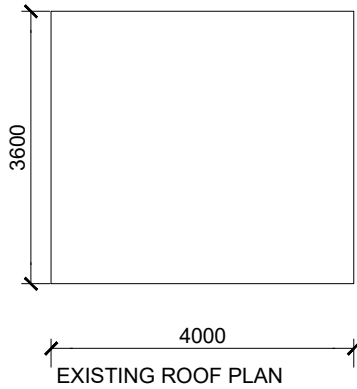
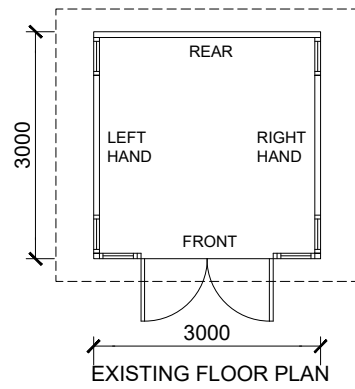

EXISTING FRONT ELEVATION

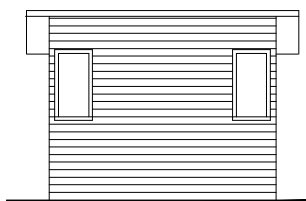

EXISTING LEFT HAND ELEVATION

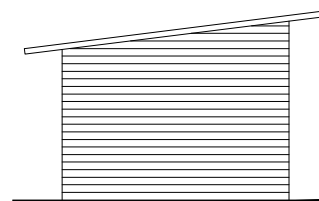

EXISTING REAR ELEVATION

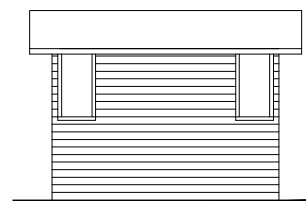

EXISTING RIGHT HAND ELEVATION

### Proposed Sun House

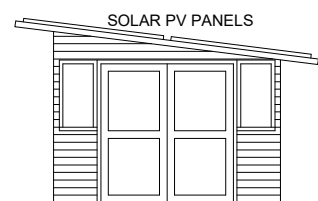
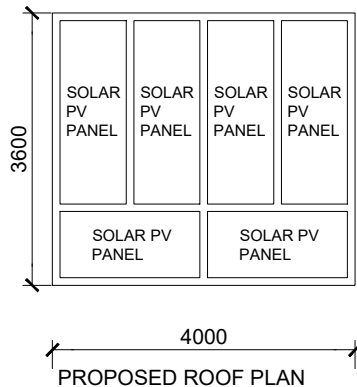
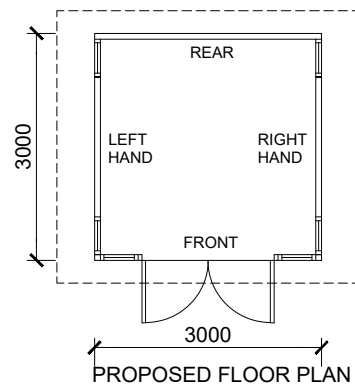

PROPOSED FRONT ELEVATION

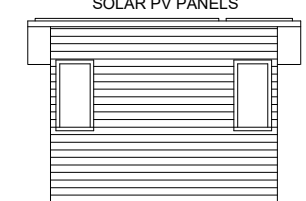

PROPOSED LEFT HAND ELEVATION

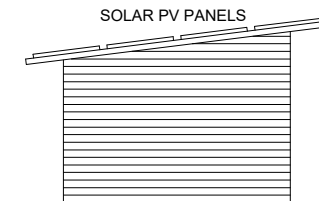

PROPOSED REAR ELEVATION

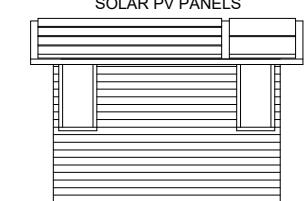

PROPOSED RIGHT HAND ELEVATION

#### Revisions:



Title: Existing & Porposed Solar Panel Positions On Workshop & Sun House

1 The Bank  
Stoneleigh  
CV8 3DA

Drg No: 121/01

Scale: 1:100 @ A3 Date: July '22

Drawn By: CAG

Kenilworth Architectural & CAD Services  
27 Queens Road, Kenilworth, Warwickshire, CV8 1JQ  
Tel: 07549 193130  
e-mail: enquires@kacad.co.uk  
web: www.kacad.co.uk