

SUNHOUSE

EXISTING ROOF
PLN

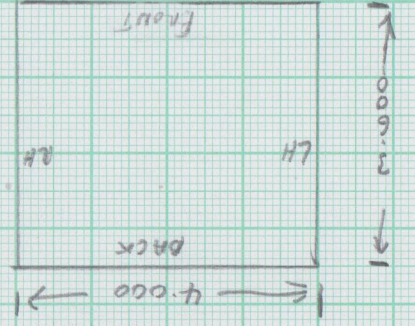

PROPOSED ROOF
PLN WITH SOLAR PV PANELS

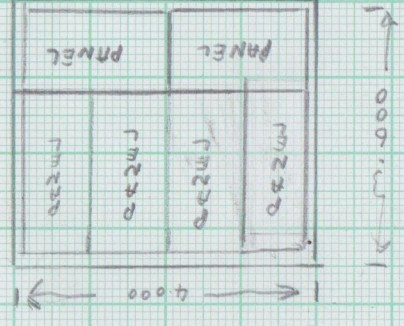

PROPOSED FRONT
ELEVATION

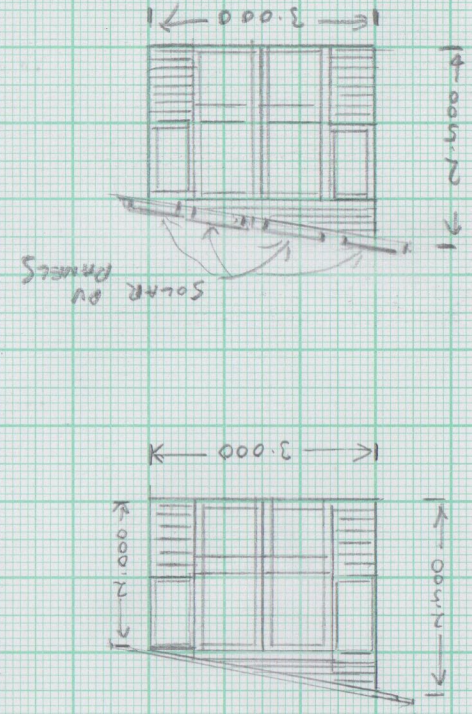

EXISTING FRONT
ELEVATION

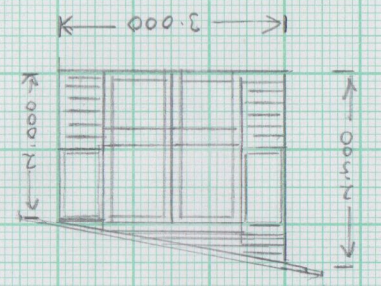

PROPOSED RH
ELEVATION

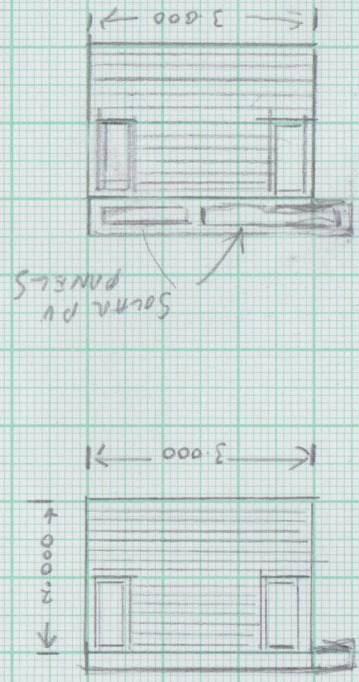

RH EXISTING
ELEVATION

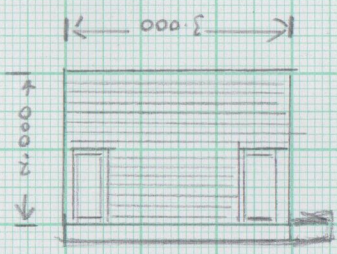

PROPOSED BACK
ELEVATION

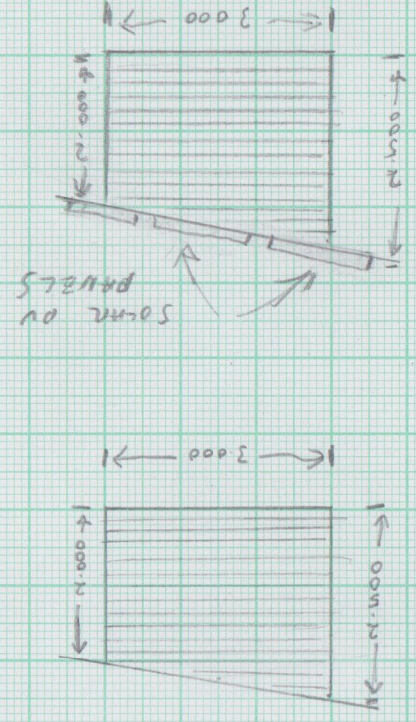

BACK EXISTING
ELEVATION

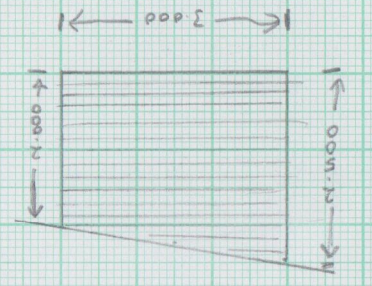

PROPOSED LH
ELEVATION

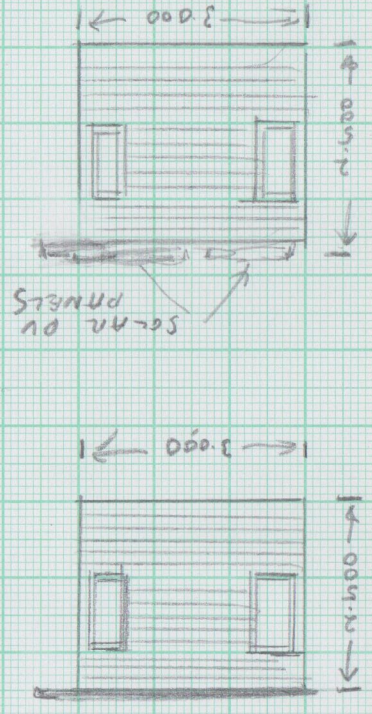

LH EXISTING
ELEVATION

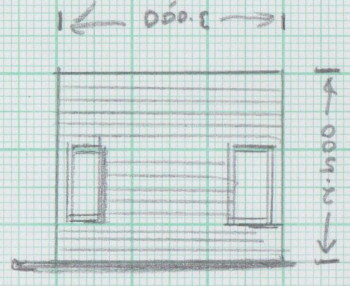

1:100 (A) A4
SCALE

MR. P. BOJHA
THE BANK
STUNTEIGH
CV 30A

WORKSHOP 5 METRES X 4 METRES

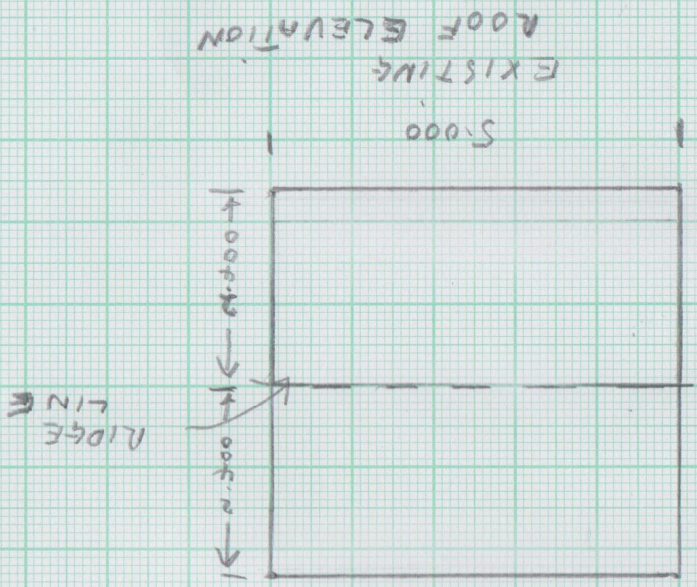
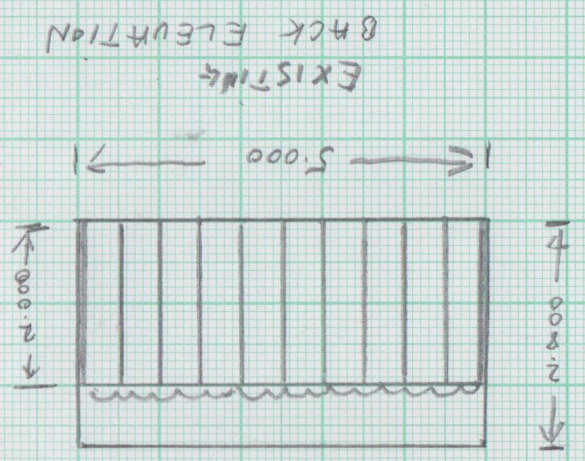
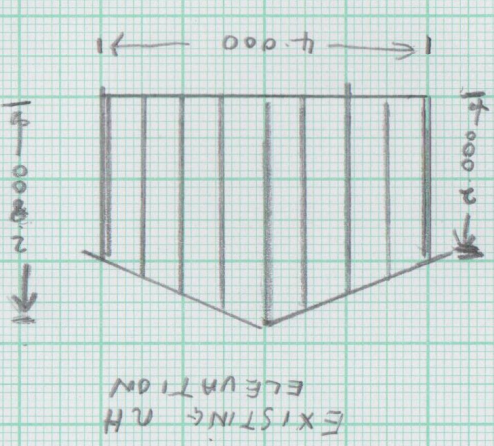
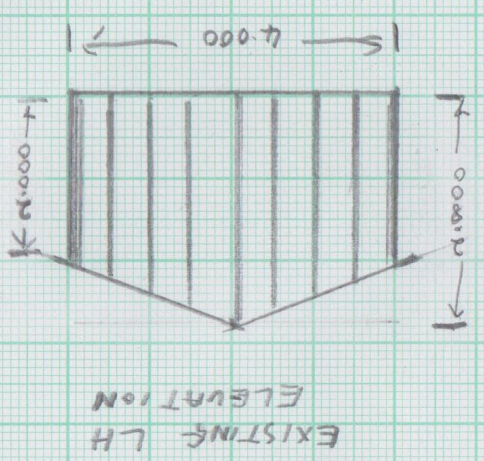
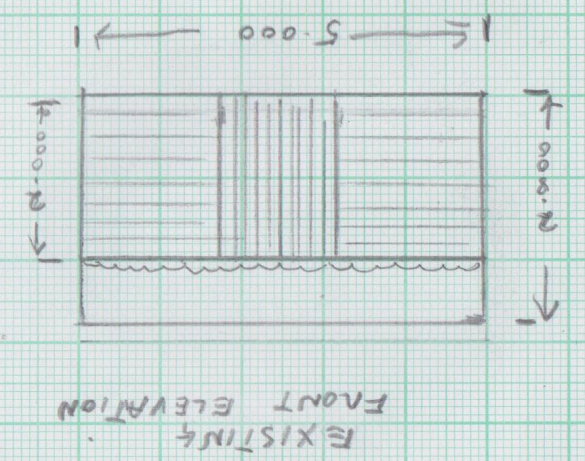

MR. P. BOJAN
 1 THE BRUK
 STONELIGHT CV8304
 SCALE
 1:100 @ A4

WORKSHOP 5 METRES X 4 METRES

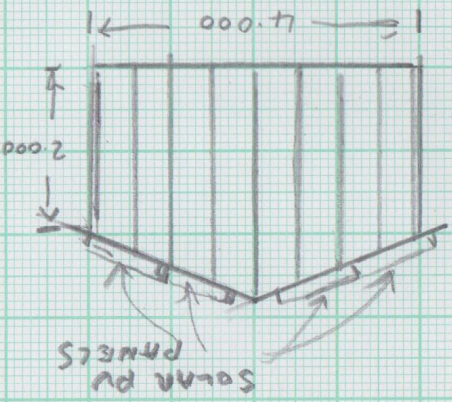
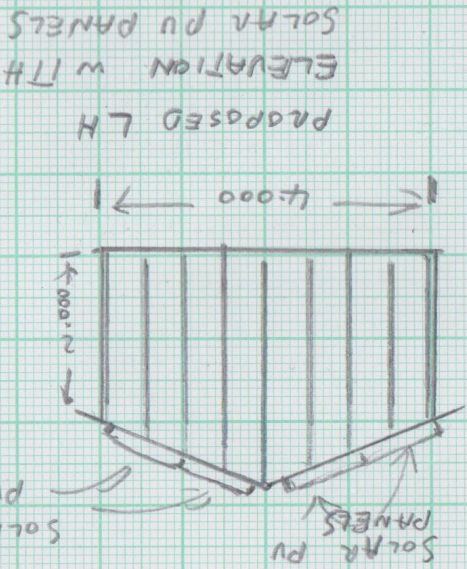
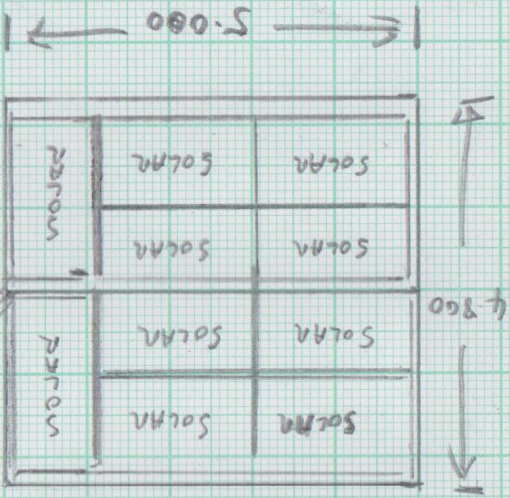
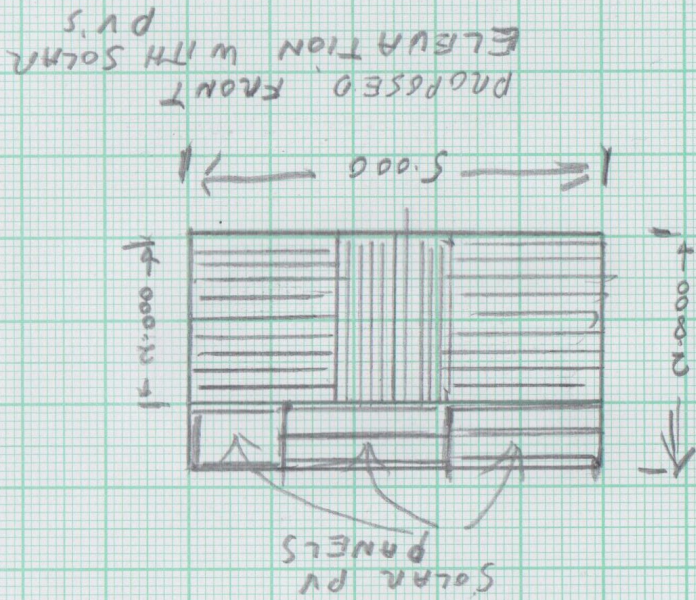
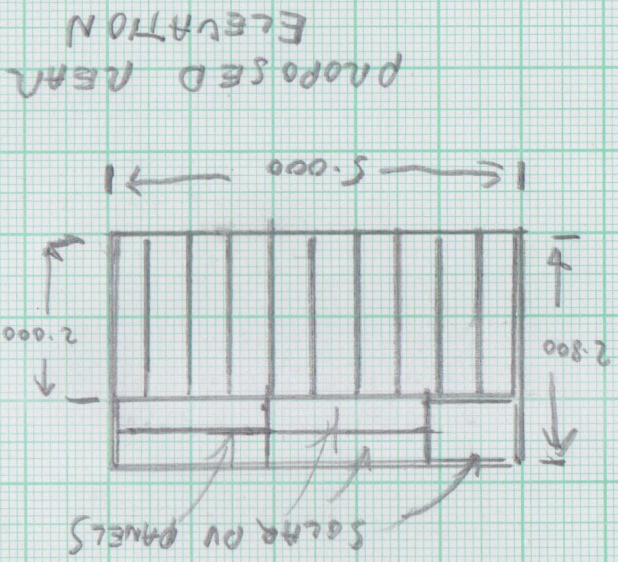

1:100 @ A4
SCALE

MR. P. BOJAN

THE BANK STONELINE

CUR 304