

# System Datasheet

## FS10-S, FS10-S XL , FS18-S XL

### General

System	Ballasted PV-mounting system
Content	Ground rails, rail connector, building protection mat, low post, high post, wind deflector, clamps
System warranty	10 years
Application area	Flat roof on industrial, agricultural (except hydrogen sulfide exposition ) and residential buildings
Roof covering	Bitumen, concrete, foil, gravel
Roof slope	max. 5° without additional measures

### System properties

System orientation	South
Module tilt	Roof paralell
System weight approx.	2.2 kg/m <sup>2</sup> (FS10-S) / 2.3 kg/m <sup>2</sup> (FS18-S) plus ballast (project specific)
Weight PV-module included approx.:	9.3 kg/m <sup>2</sup> (FS10-S) / 8.1 kg/m <sup>2</sup> (FS18-S) plus ballast (project specific)
Friction coefficient	$\mu = 0,5$ is to be determined and ensured upon installation surface.
Material	Aluminum, stainless steel , strip-galvanized steel metal sheet, rubber granulate
Minimum edge distance	0,6 m
Shading angle	12° to 17.5°

### Modules

Type	Approval for panel corner clamping is to be obtained.
Module size (max)	FS10-S: 950-1.052 mm / FS10-S XL: 1.053-1.168 mm / FS18S XL: 990-1.065 mm
Module guidance	Horizontal/Landscape

### Certifications

Wind loads	Determined in wind tunnel tests by Ruscheweyh Consult GmbH
------------	--

### Services

PV layout	Provided by Renusol ( <a href="http://www.pv-configurator.com">www.pv-configurator.com</a> )
-----------	--

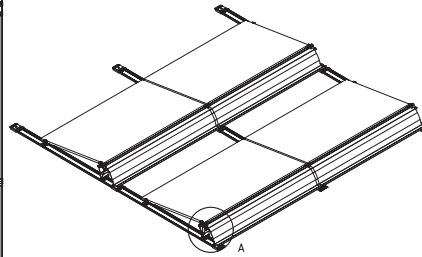
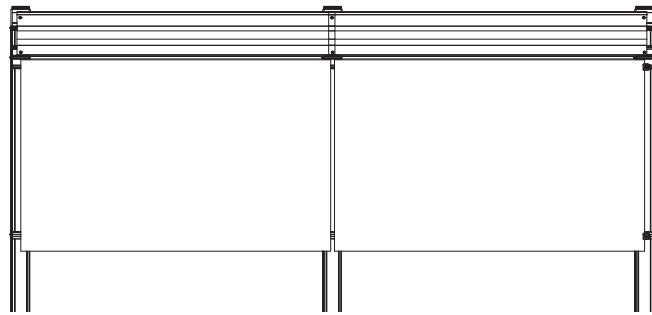
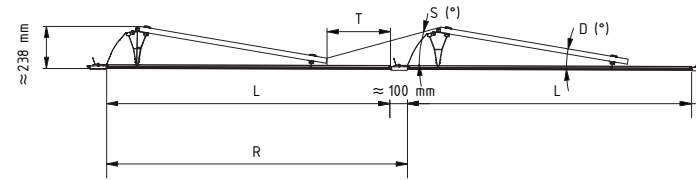
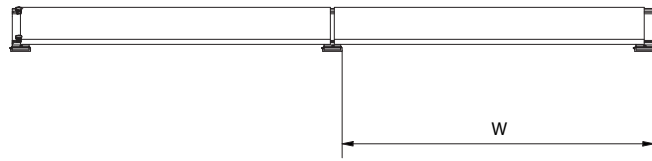

A ( 1 : 10 )  
FS10-S

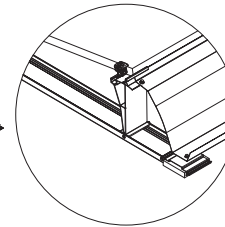

A ( 1 : 10 )  
FS10-S XL

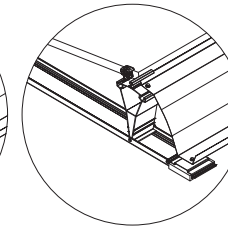

A ( 1 : 10 )  
FS18-S XL

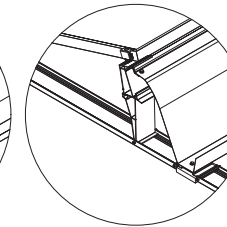

System		FS10-S	FS10-S	FS10-S XL
Bottom rail		R500400	R500402	R500409
Rail length	L:	1389 mm	1639 mm	1639 mm
Row spacing	R:	1490 mm	1740 mm	1740 mm
Module width	X:	Min: 950 mm	Min: 950 mm	Min: 1053 mm
		Max: 1052 mm	Max: 1052 mm	Max: 1168 mm
Throughway without Streamliner	T(X):	Min: 466 mm	Min: 716 mm	Min: 618 mm
		Max: 404 mm	Max: 654 mm	Max: 505 mm
Throughway with Streamliner	T(X):	Min: 281 mm	Min: 531 mm	Min: 433 mm
		Max: 219 mm	Max: 469 mm	Max: 320 mm
System width	W:	Modullänge + 24 mm	Modullänge + 24 mm	Modullänge + 24 mm
Module inclination	D:	10°	10°	10°
Shading angle	S:	18,2° - 21,7°	11,0° - 13,8°	13,8° - 18,2°

System		FS18-S XL	FS18-S XL
Bottom rail		R500505	R500506
Rail length	L:	1739 mm	1989 mm
Row spacing	R:	1840 mm	2090 mm
Module width	X:	Min: 990 mm	Min: 990 mm
		Max: 1065 mm	Max: 1065 mm
Throughway without Streamliner	T(X):	Min: 818 mm	Min: 1068 mm
		Max: 742 mm	Max: 1318 mm
Throughway with Streamliner	T(X):	Min: 532 mm	Min: 782 mm
		Max: 456 mm	Min: 706 mm
System width	W:	Modullänge + 24 mm	Modullänge + 24 mm
Module inclination	D:	17°	17°
Shading angle	S:	17,4° - 20,3°	13,7°-15,8°