

SCALE 1-50

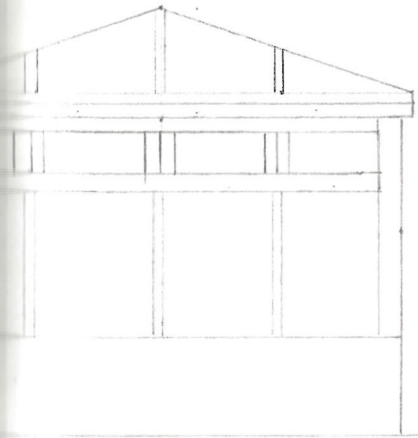

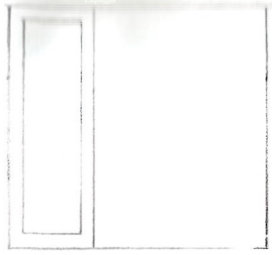

REAR

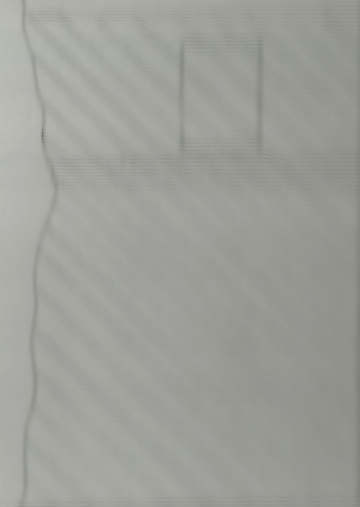
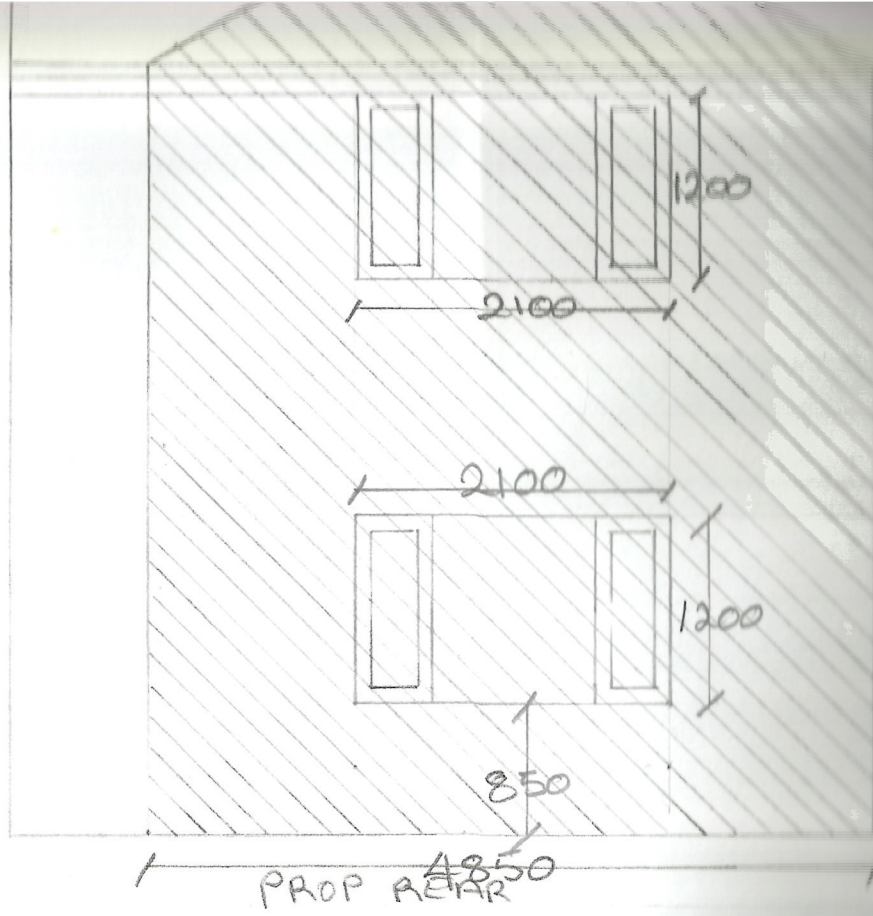

SCALE



EX PLAN

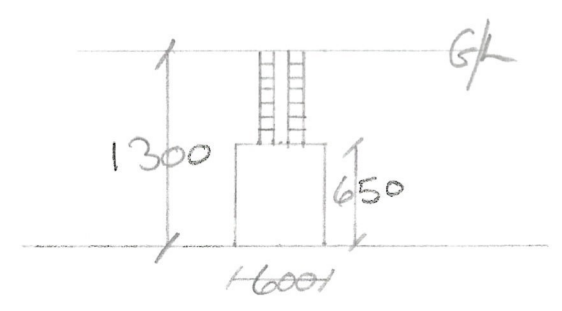

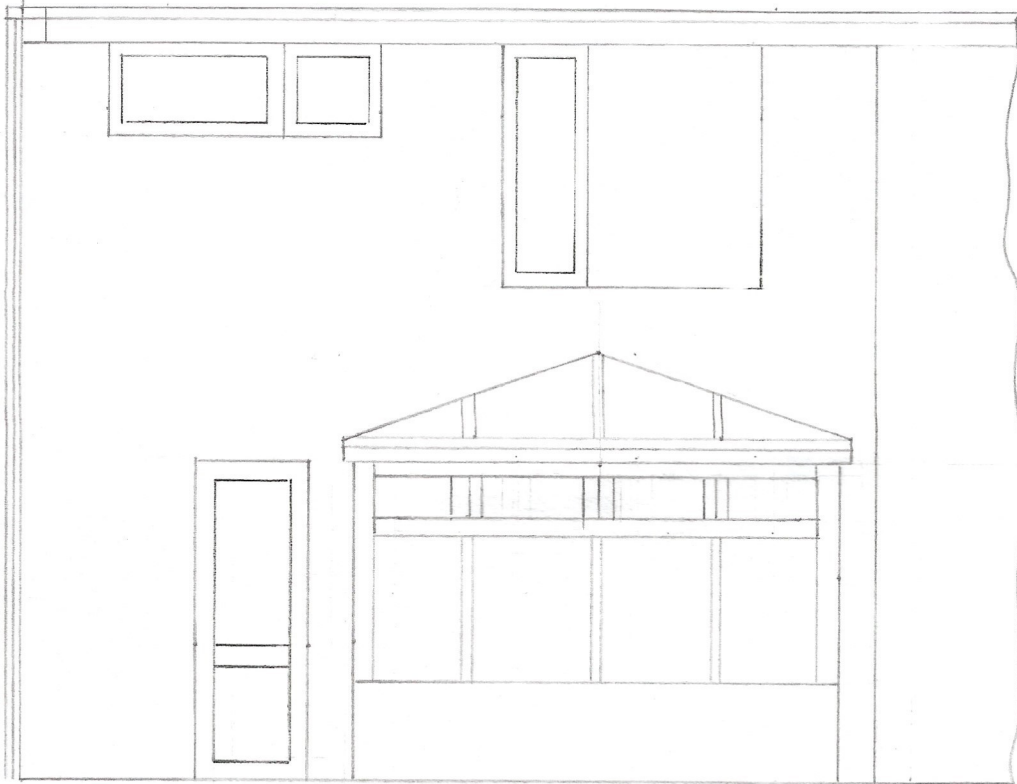

EX REAR

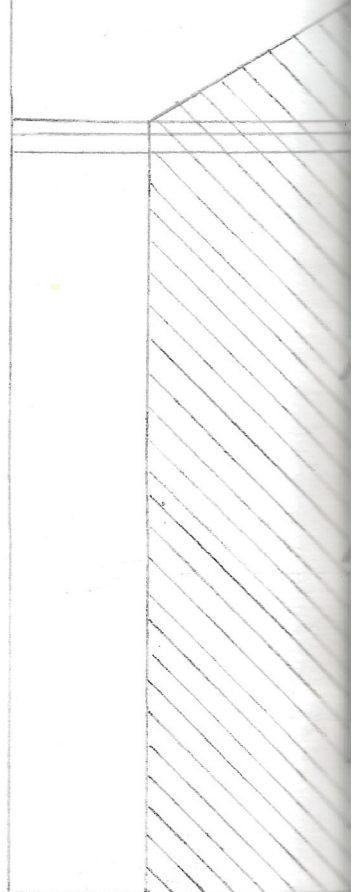

PROF

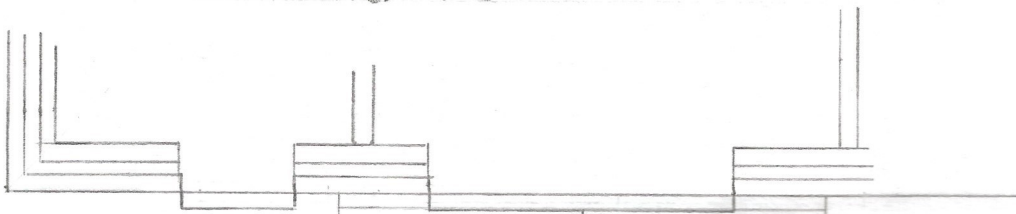

EX PLAN

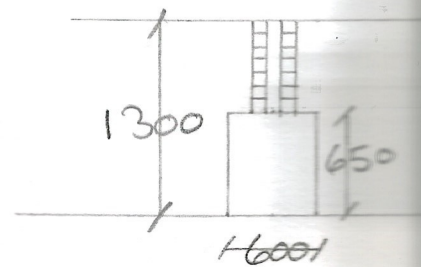
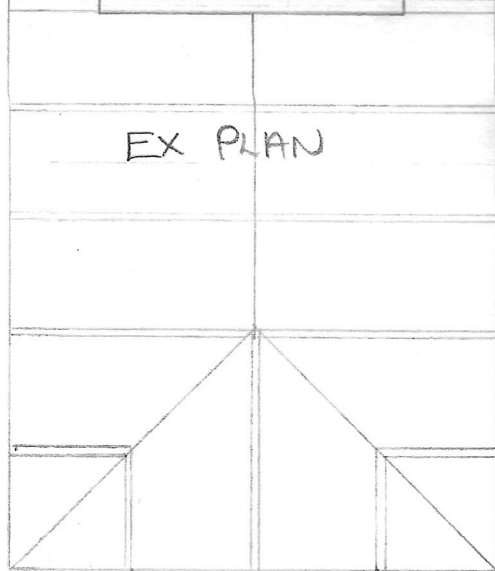

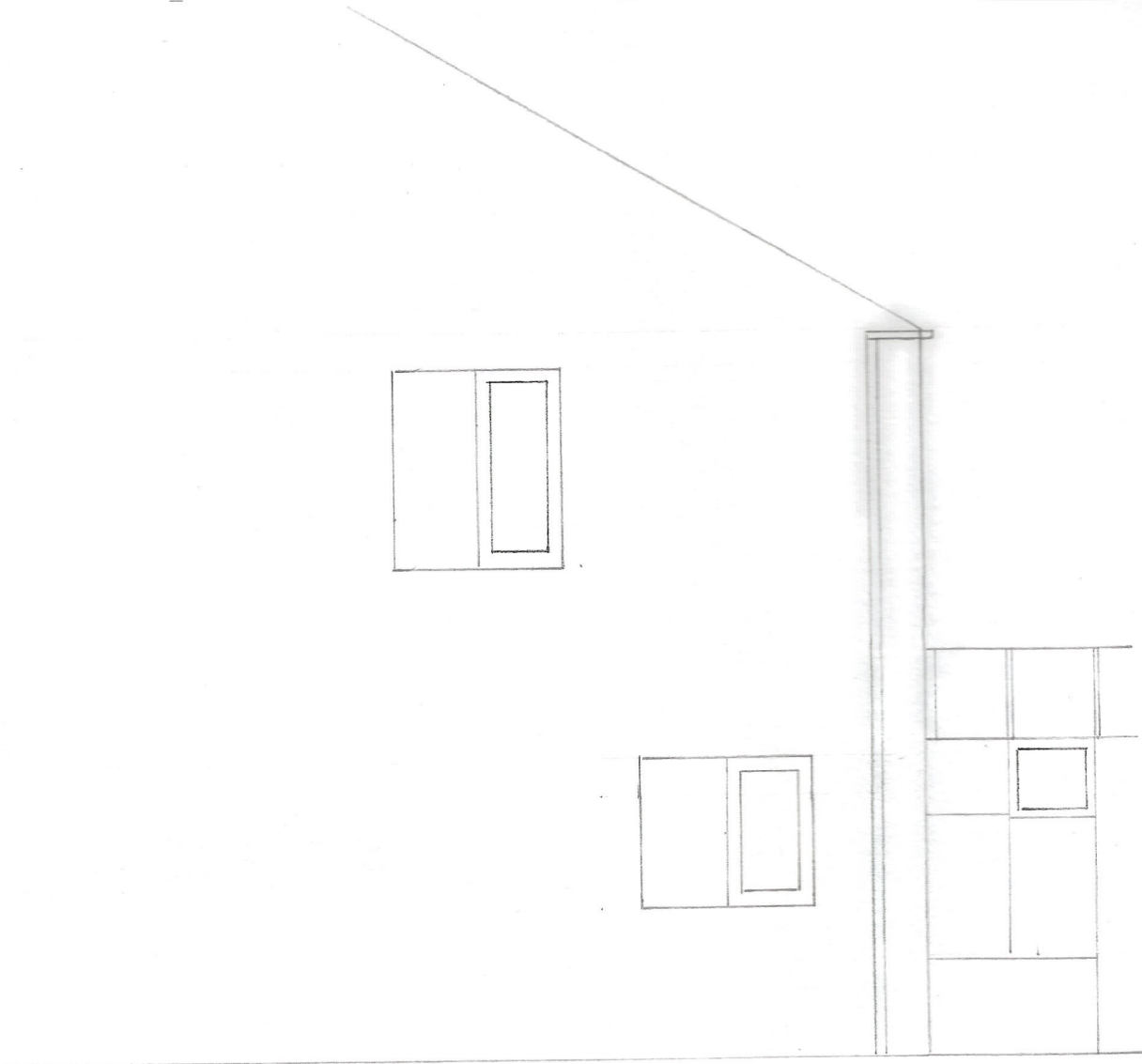

EX SIDE

