

PLAN DETAILS 1:2 Scale
HALF GLAZED DOOR

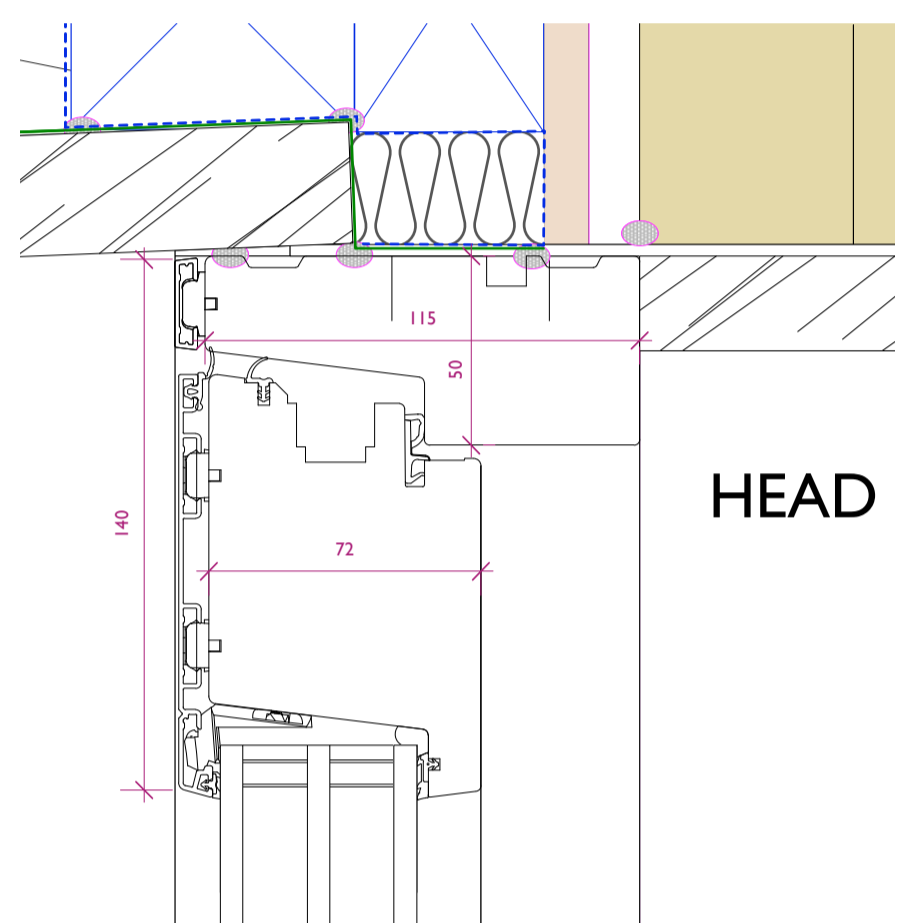

HEAD

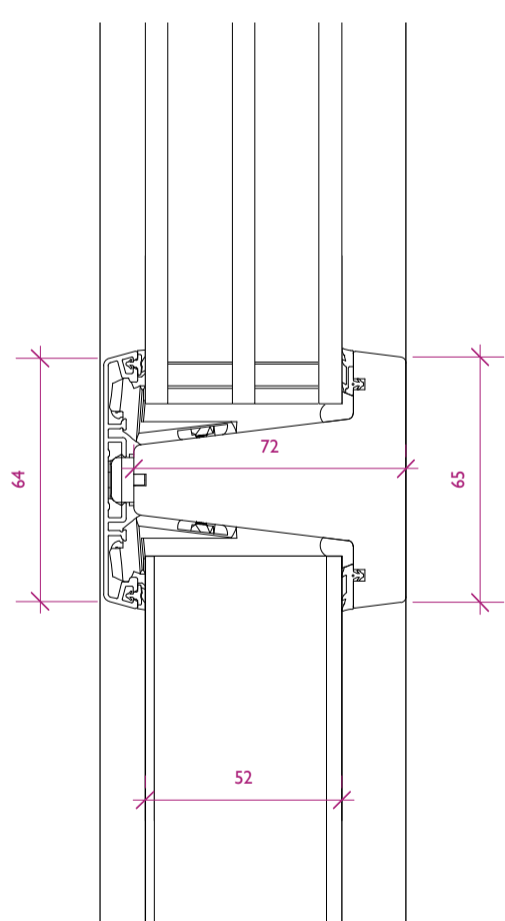

MID RAIL

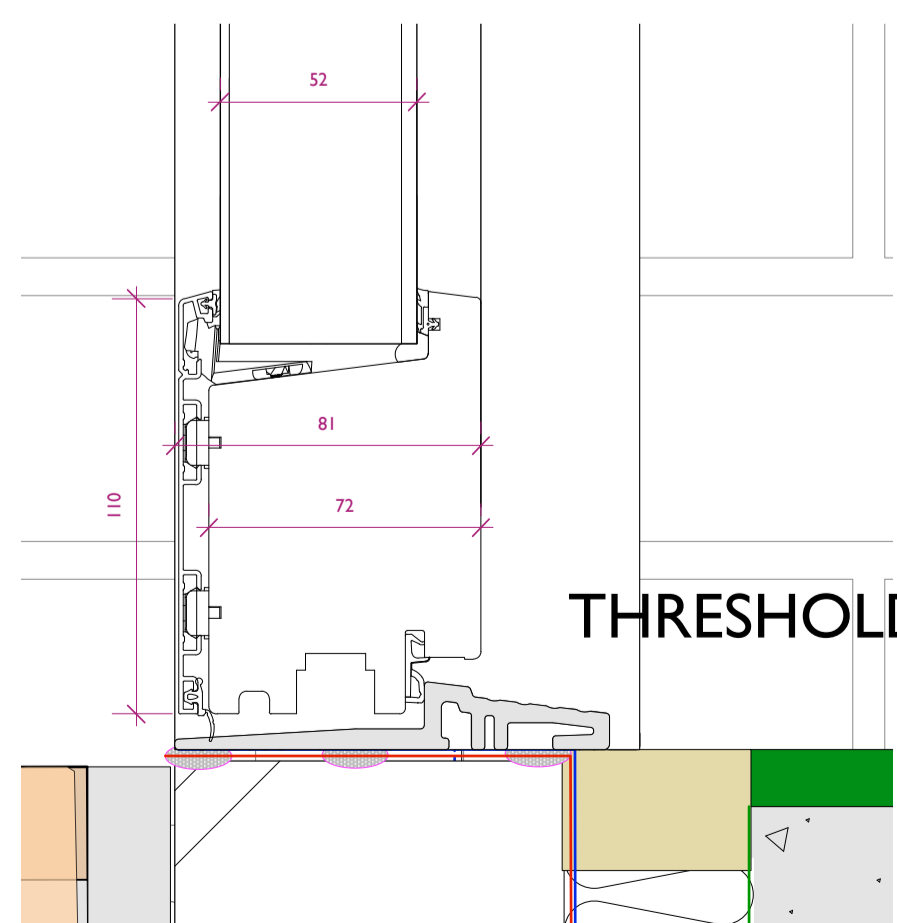

THRESHOLD

DOOR SECTION DETAILS 1:2 Scale

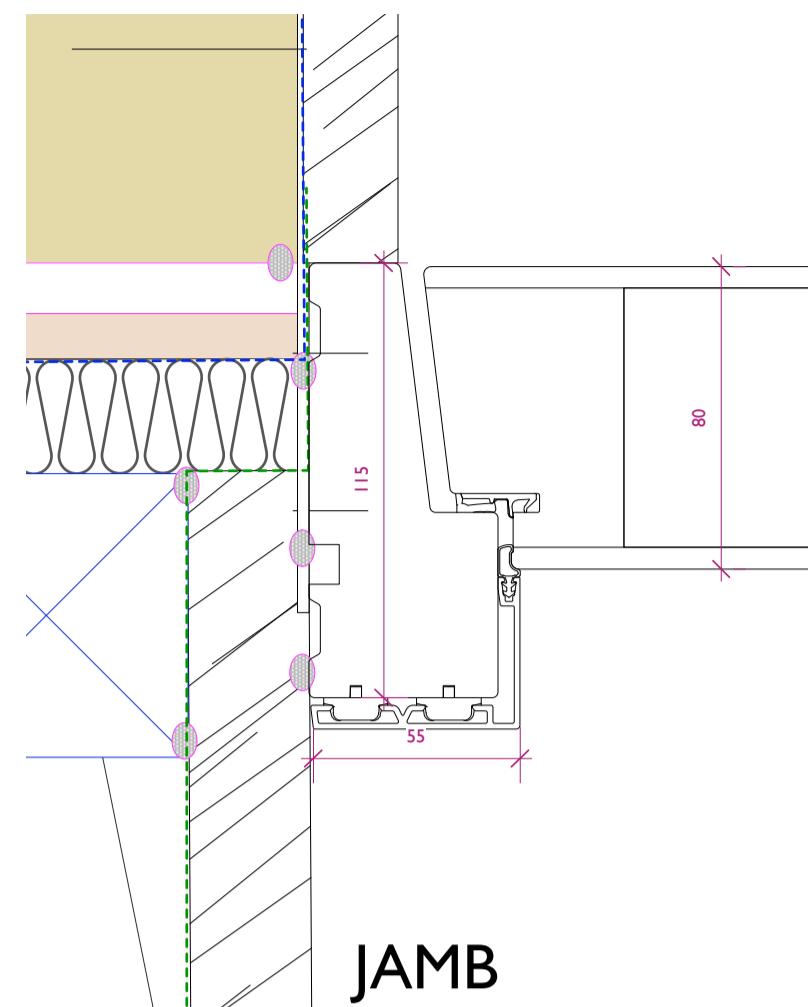

JAMB

PLAN DETAILS 1:2 Scale
SOLID DOOR

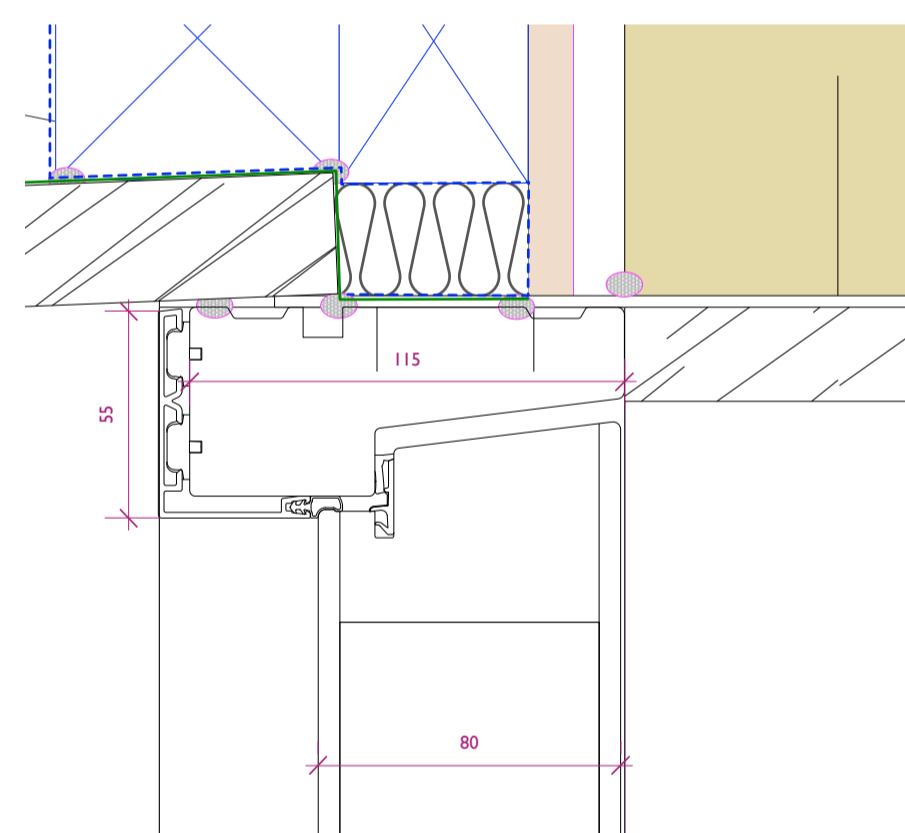

HEAD

SOLID DOOR

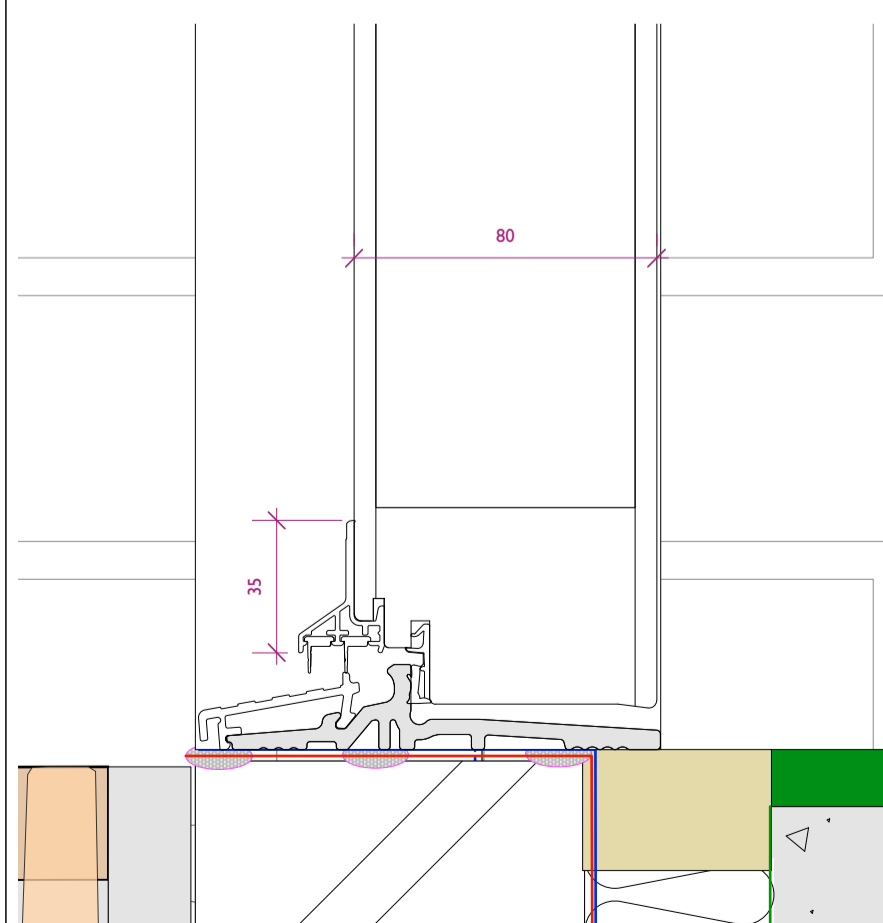

THRESHOLD

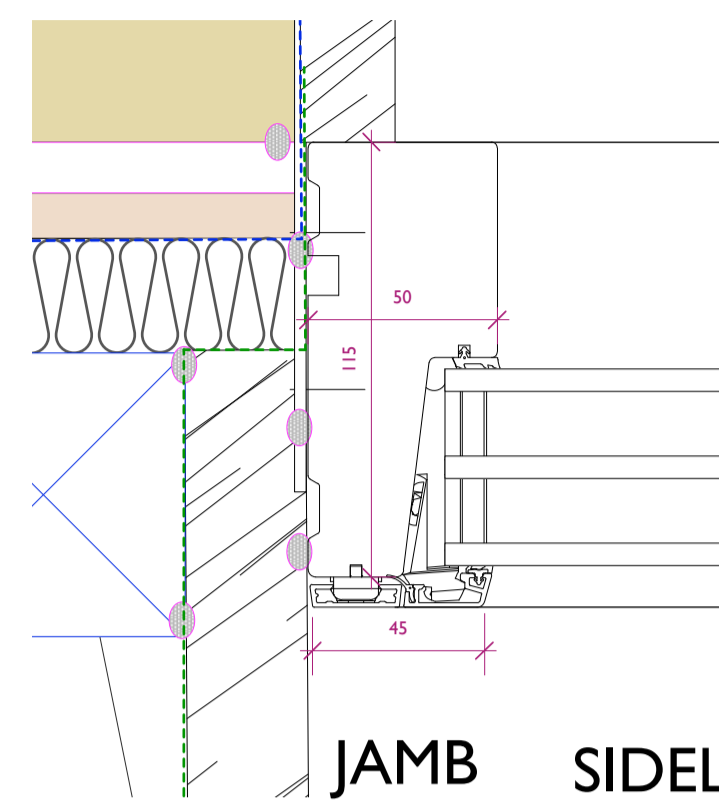

JAMB

SIDELIGHT

DOOR / SIDELIGHT
JUNCTION

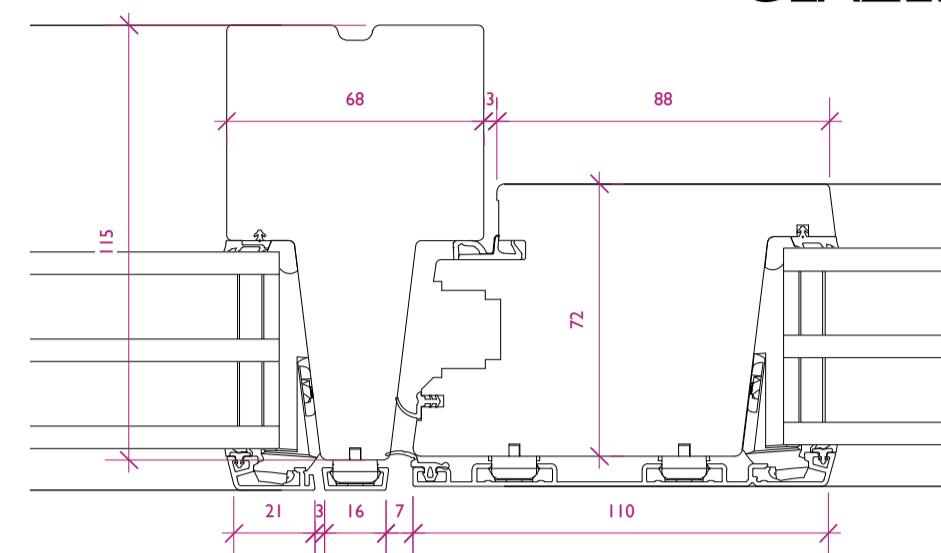

GLAZED DOOR

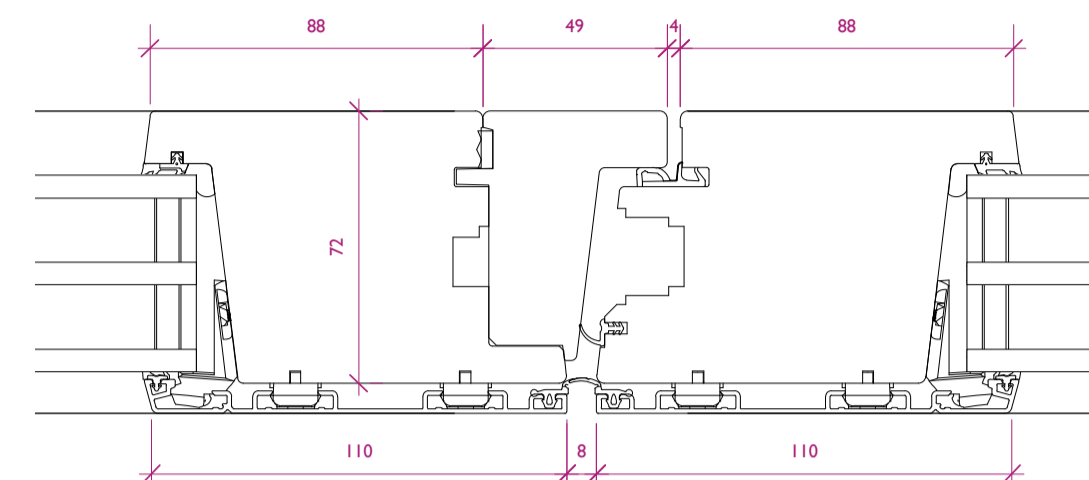

MEETING STILES

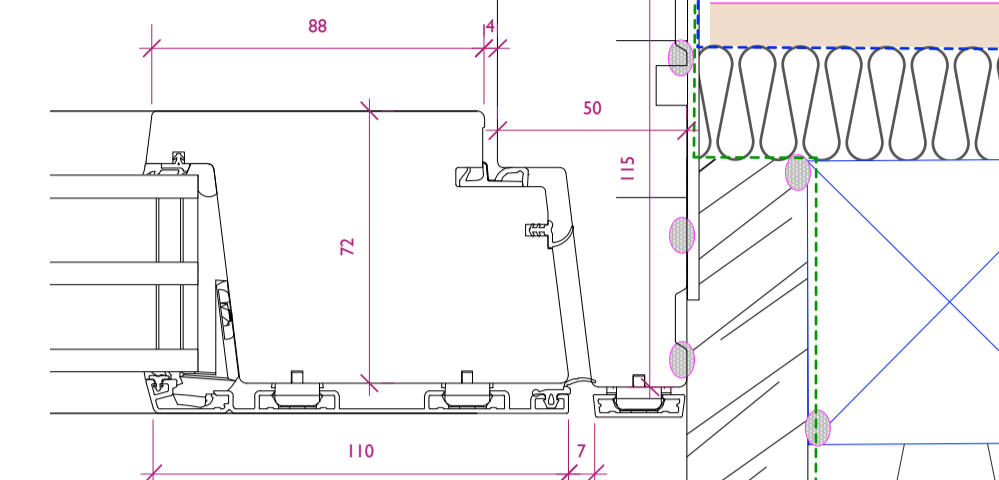

JAMB

PLAN DETAILS 1:2 Scale

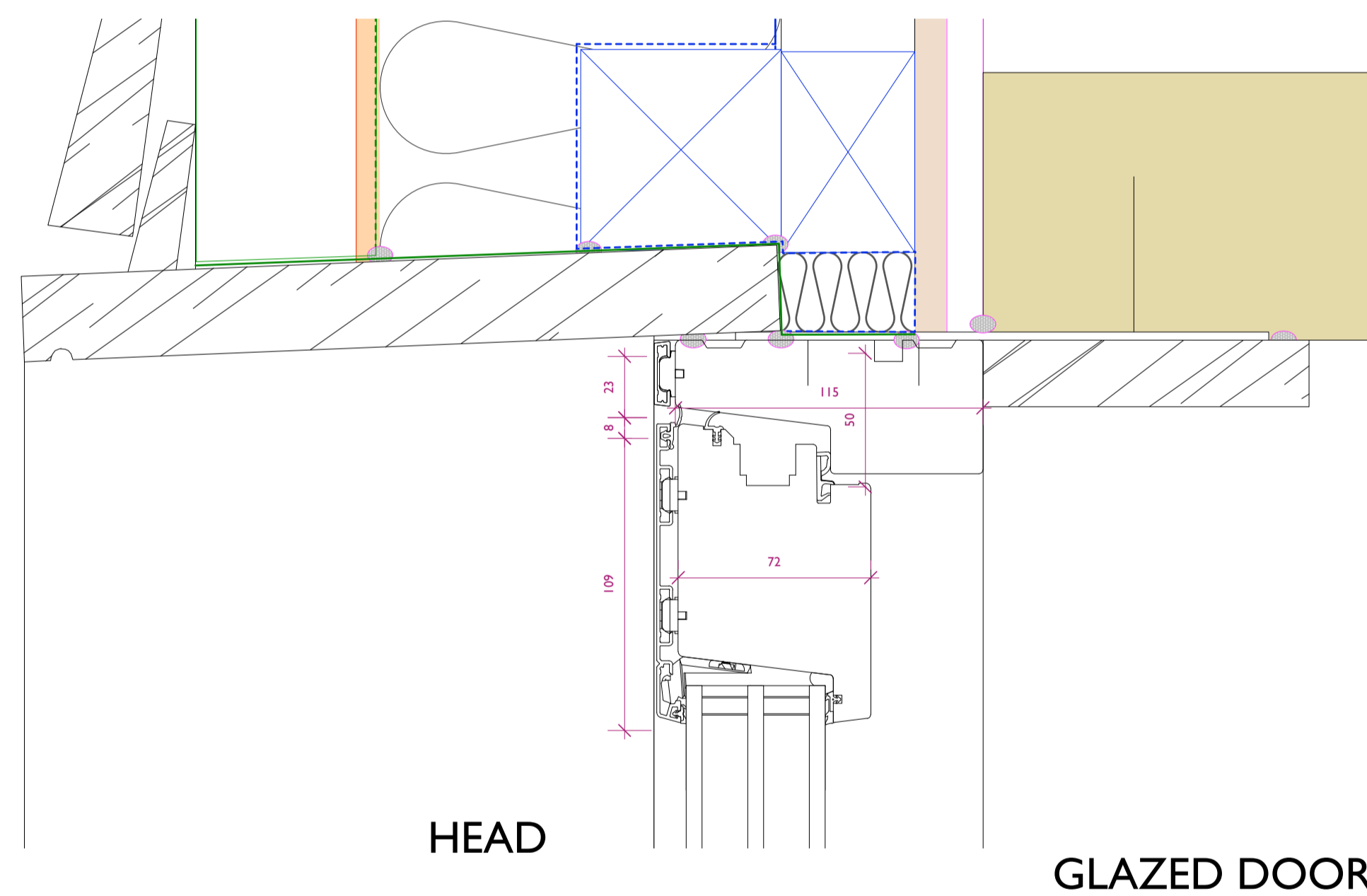

HEAD

GLAZED DOOR

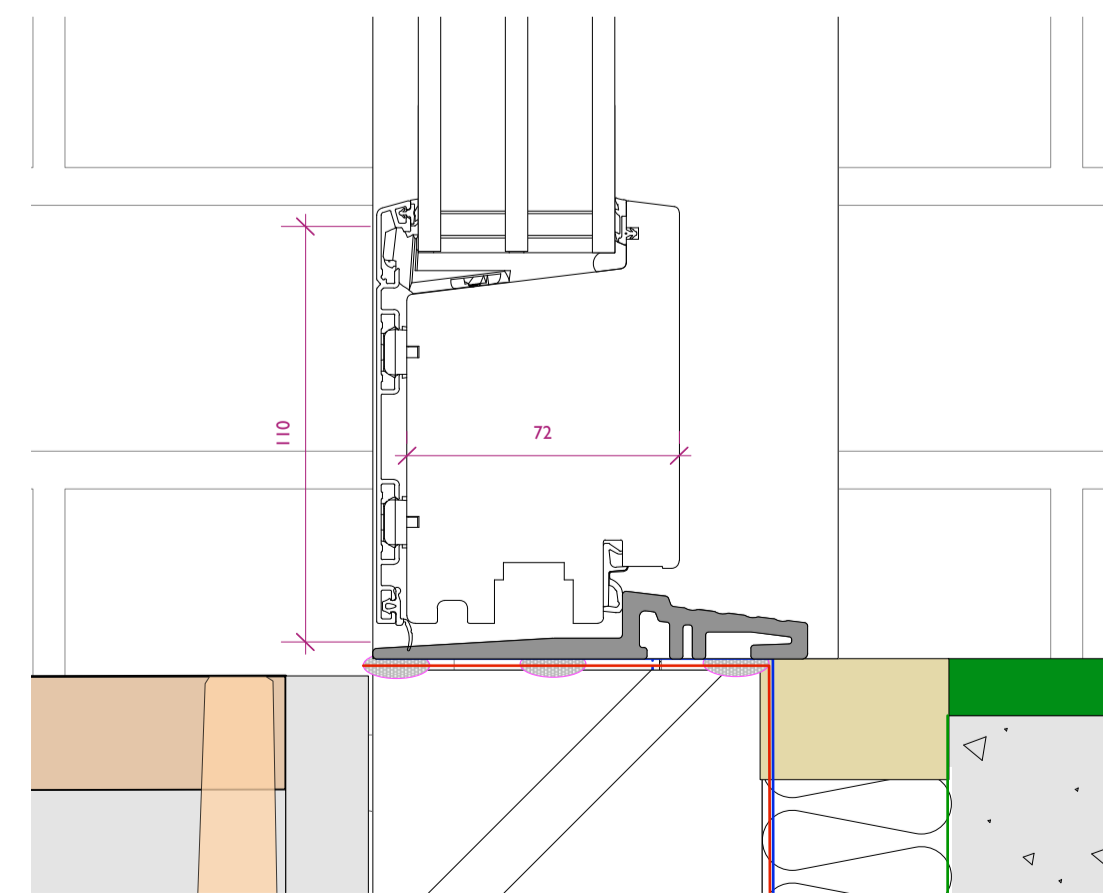

THRESHOLD

DOOR SECTION DETAILS 1:2 Scale

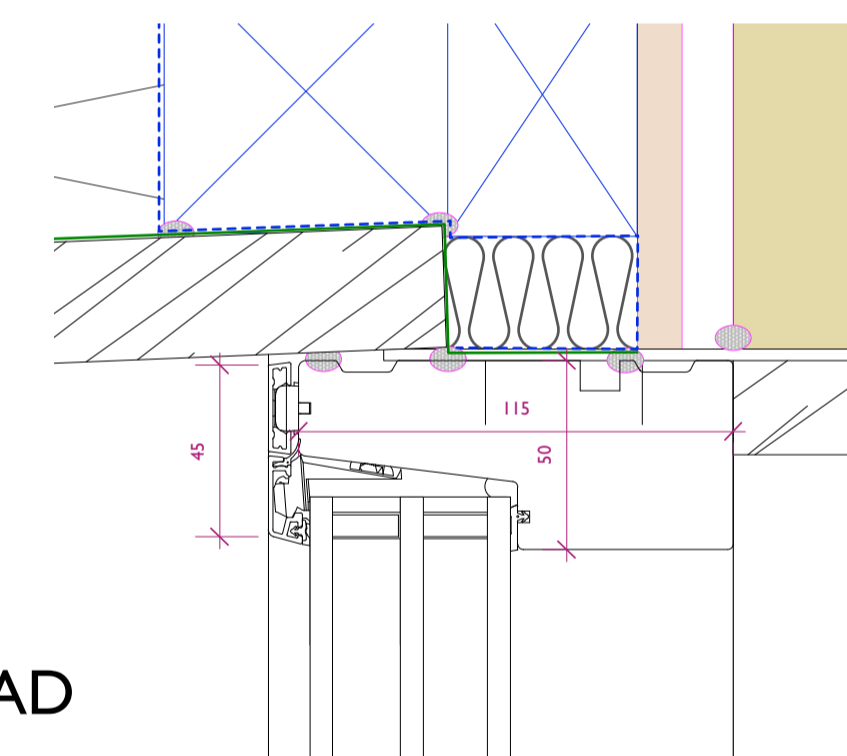

HEAD

WINDOW
ABOVE DOOR

TRANSOM

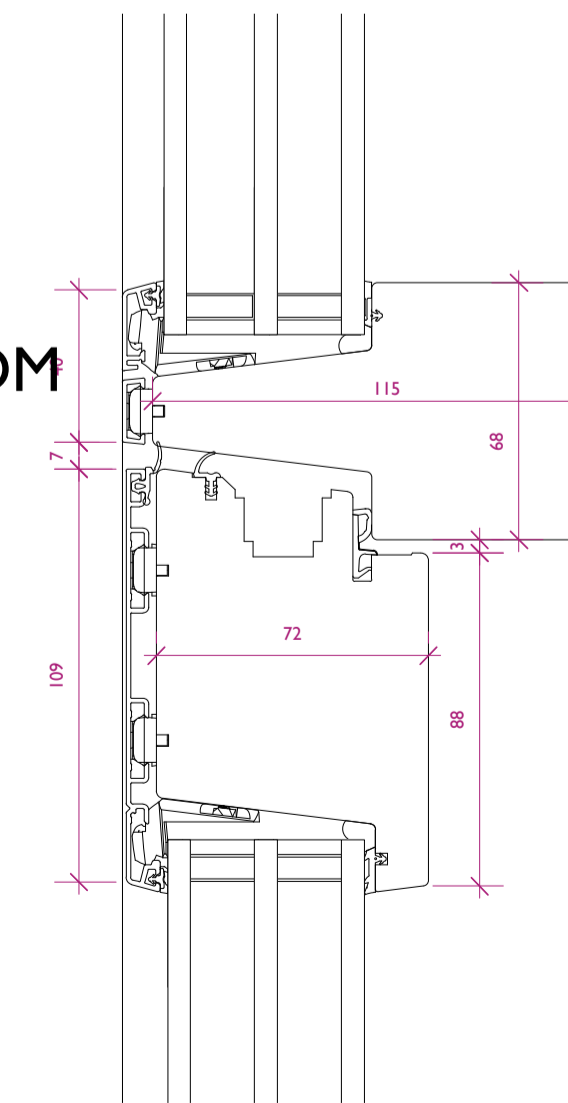

SECTION DETAILS 1:2 Scale

General Notes

1. Do not scale this drawing. All dimensions to be as noted. Contractor to check all dimensions on site before carry out work.
2. This drawing is for the private and confidential use of the client for whom it was undertaken and it should not be reproduced in whole or in part or relied upon by third parties for any use without the express written authority of Beech Architects Limited.

Rev

	Church Farm Barn The Street Thornodon Suffolk IP23 7JR
	enquiries@beecharchitects.com t 01379 678442

CLIENT

Mr & Mrs Macklin

PROJECT

Peacocks Barn
 Farley Green
 Suffolk
 CB8 8PX

DRAWING

Door Details

SCALE	DATE	DRAWN BY	CHECKED
1:2 @ A1	MAR 2021		
DRAWING NUMBER	JOB NUMBER	STATUS	REV
57	564	Not For Construction	

This drawing is copyright and remains the property of Beech Architects Ltd. Original size: A1. Scale shown will be incorrect if reproduced in any other format. All dimensions to be checked on site.