

**Tank Farm
Storage / Balancing Tanks**

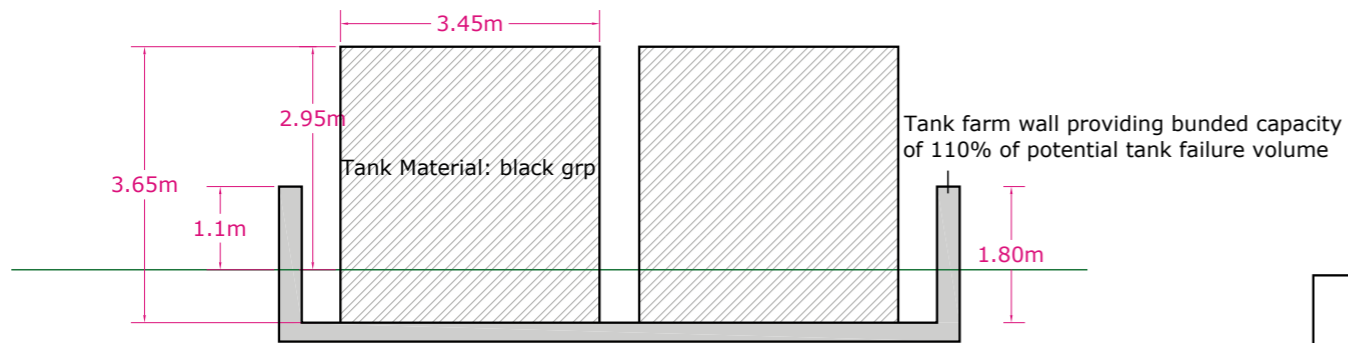

Control Cabin

Plan



Elevations

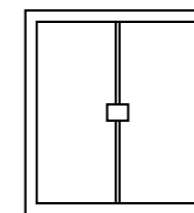
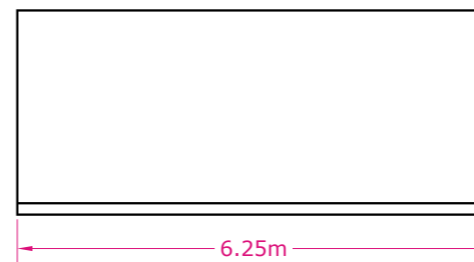
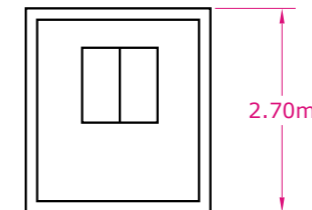
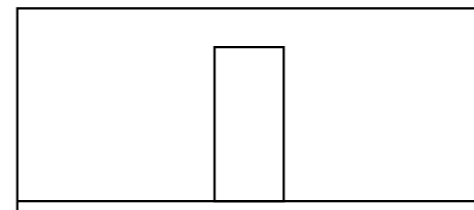

6.25m by 2.44m by 2.7m corrugated steel container painted green (RAL6002)

Self Bunded Caustic Tank

Elevation

Plan

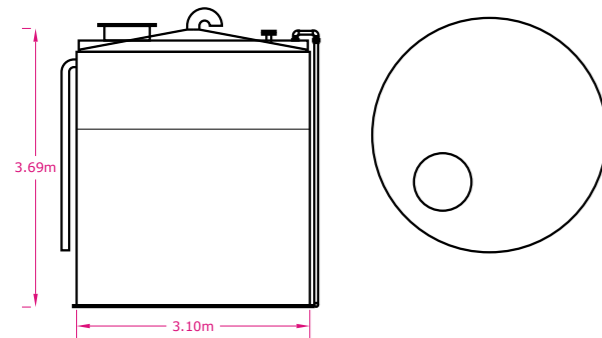

**Clean Water Tank
glass reinforced plastic IBC
finished in white**

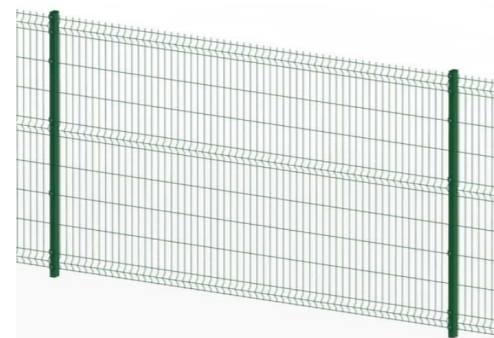
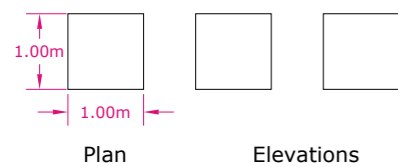

Proposed Fence Height 1.8m
Proposed Panel length 3.0m
(not to scale)



Proposed Gate Height 1.8m
(not to scale)



Units 3-5 Greystriars Business Park,
Frank Foley Way, Stafford, ST16 2ST
Tel: 01785 251555

Contains Ordnance Survey Data
(c) Crown copyright and database right 2022.
All rights reserved.
Licence number AL100004923

Revision:	Details:

Site: **SHORTWOOD
PROPOSED LTP**

Title: **Tanks, Cabin & Fencing Details**

Drawn: TJG	Date: 17-1-23	Scale @A3: 1:100
---------------	------------------	---------------------

Drawing number **Plan 4**