

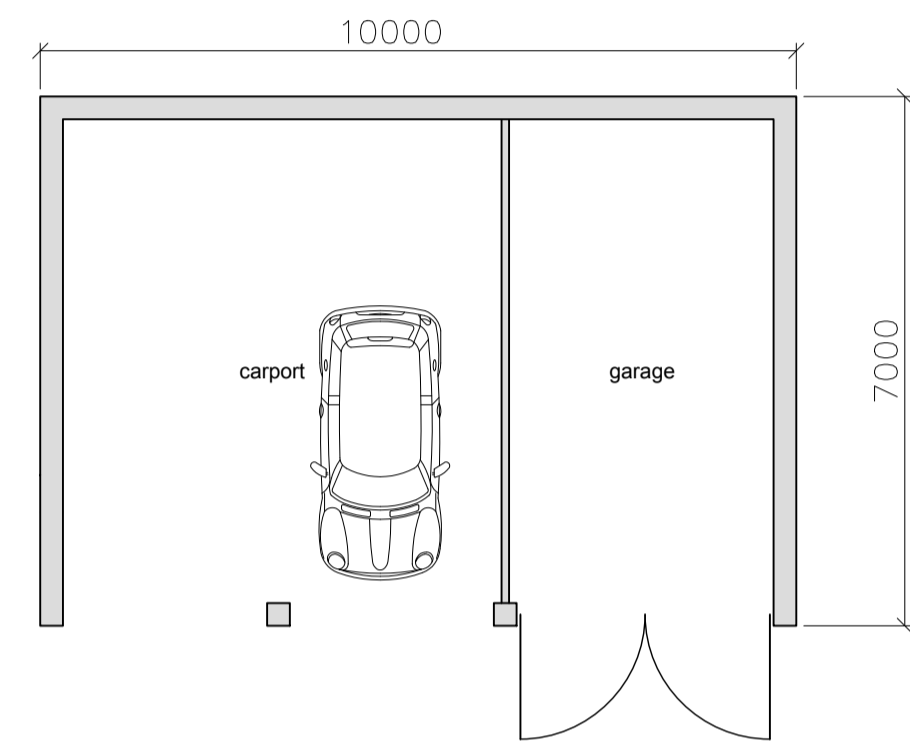

**MATERIALS:**

ROOF: Clay pantiles. Colour: Terracotta.  
WALLS: Horizontal Softwood Boards, Stained Black.  
DOORS: Softwood, Stained Black.  
RAINWATER GOODS: uPVC. Colour: Black.



Proposed ground floor plan

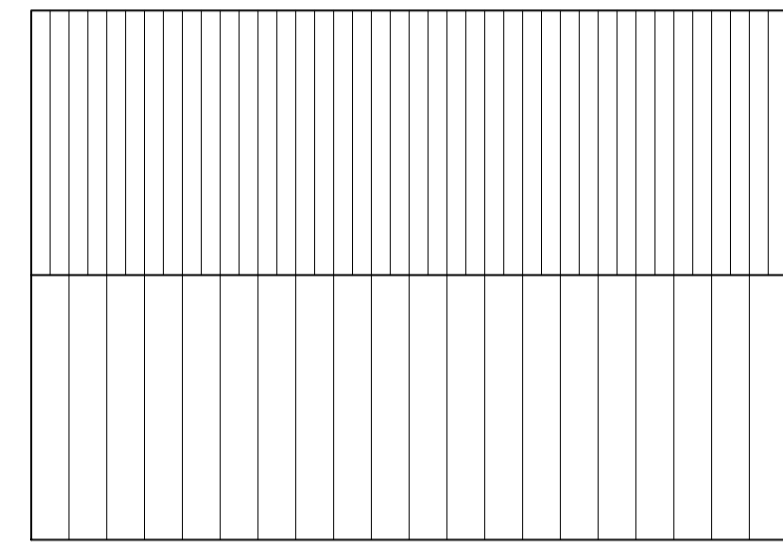

Proposed roof plan

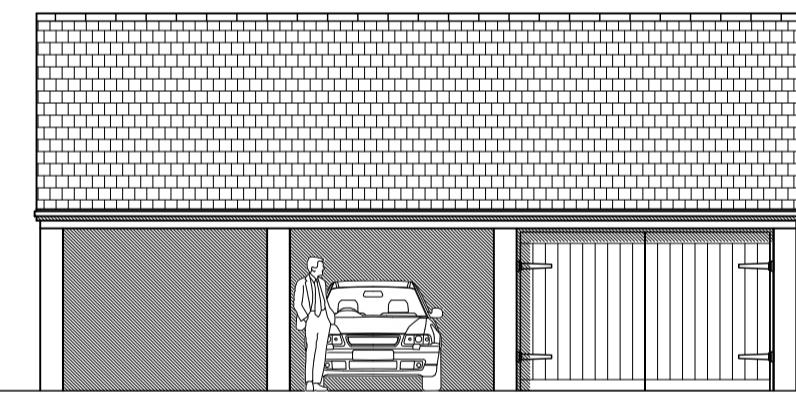

South-East Elevation

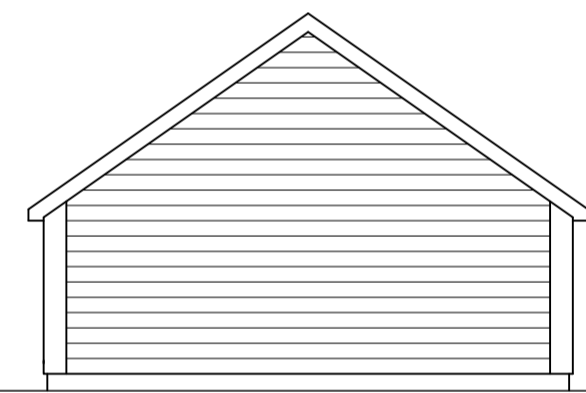

North-East Elevation

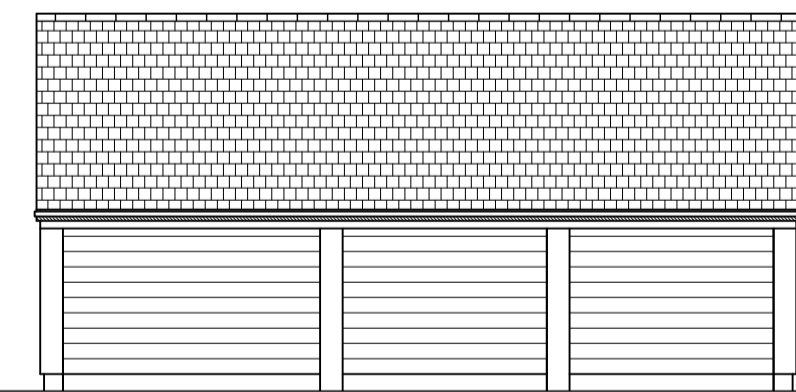

North-West Elevation

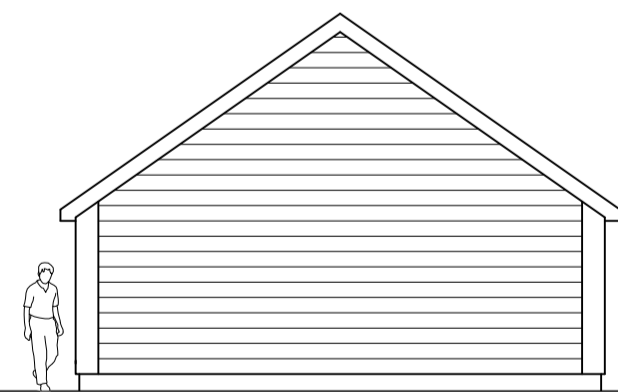

South-West Elevation

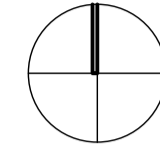
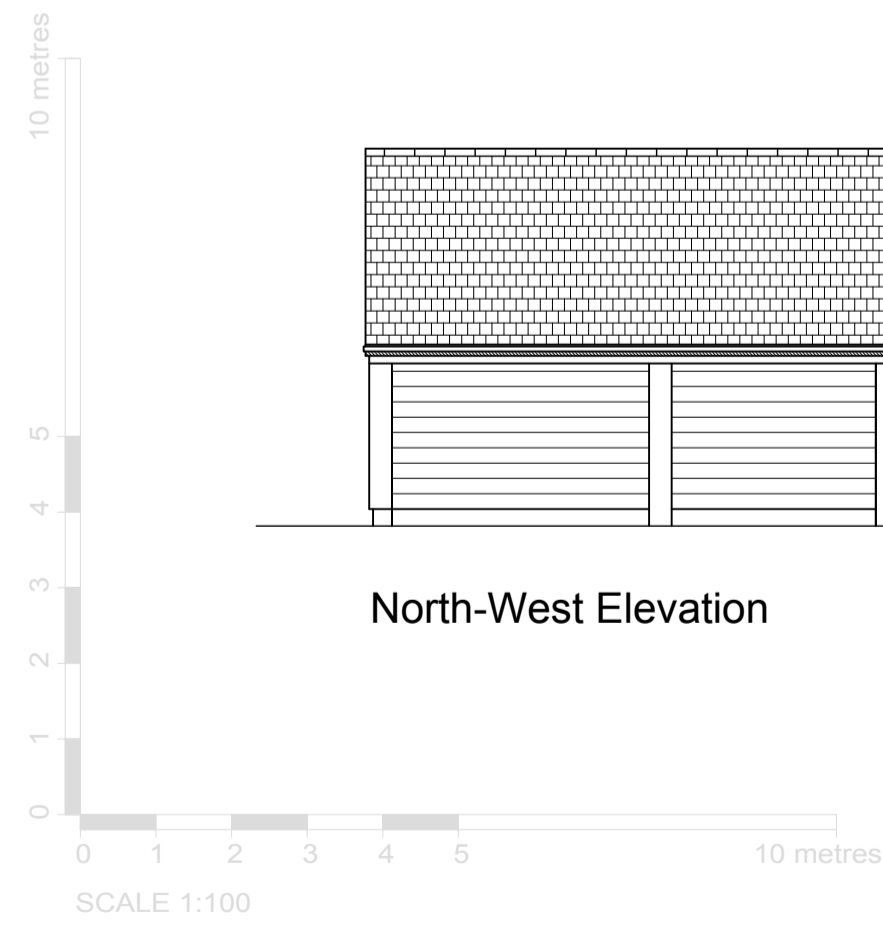

Proposed Site Plan

Date	Revision	Description	MDW	PW
			Drawn	Checked
<b>peterwellsarchitects</b>				
ferry quay house, ferry quay, woodbridge, suffolk, IP12 1BW - 01394 799299 - info@peterwellsarchitects.co.uk				
Project:	Extension to Cider Shed, Grassy Lane Farm, Woolpit			
Client:	Mr. M Peart			
Dwg Title:	Proposed Site Plan & Cartlodge Plans	Dwg Status:	Planning	
Date:	January 2023	Scale:	1:100 & 1:200 @ A1	Dwg No.: PW788 PL803
<small>DISCLAIMER: This drawing was prepared for the Client, Project &amp; Site related below and for the purposes set out in the Project Particulars. Peter Wells Architects accepts no responsibility whatsoever should the drawing be used by any other person, on any other site or for any other purpose than those stated. This drawing is to be read in conjunction with all relevant drawings and specifications. ALL MEASUREMENTS ARE TO BE CHECKED ON SITE AND ANY DISCREPANCIES REPORTED TO PETER WELLS ARCHITECTS</small>				