

Tank Farm Storage / Balancing Tanks

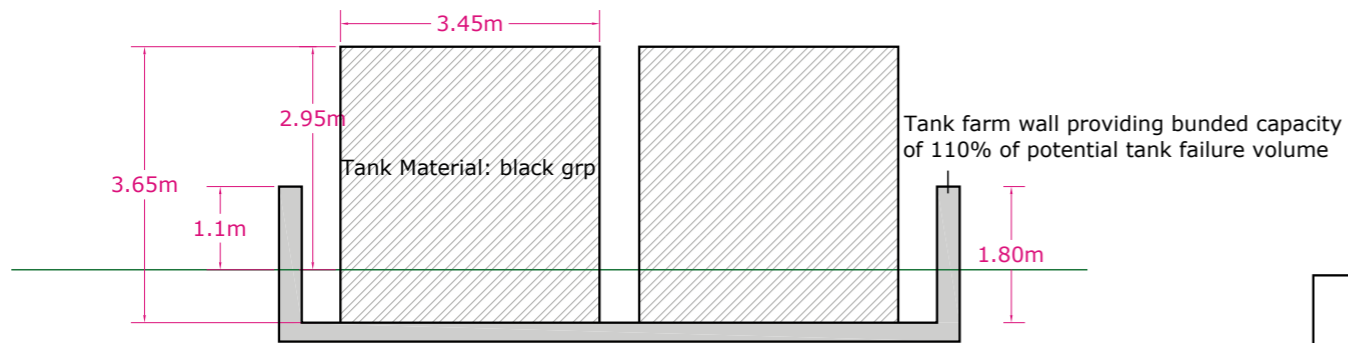

Control Cabin

Plan



Elevations

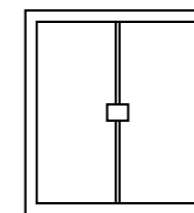
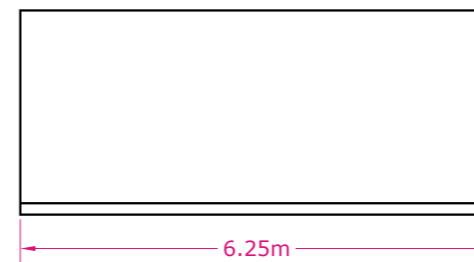
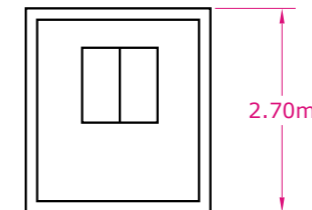
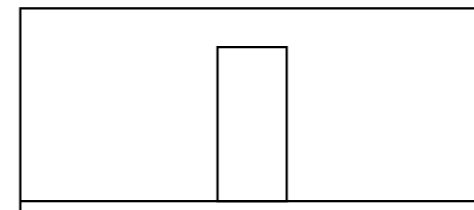

6.25m by 2.44m by 2.7m corrugated steel container painted green (RAL6002)

Self Bunded Caustic Tank

Elevation

Plan

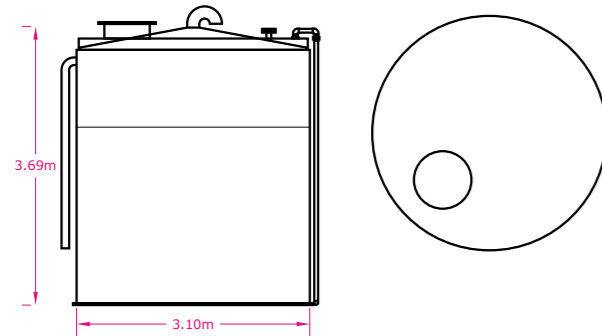

Clean Water Tank glass reinforced plastic IBC finished in white

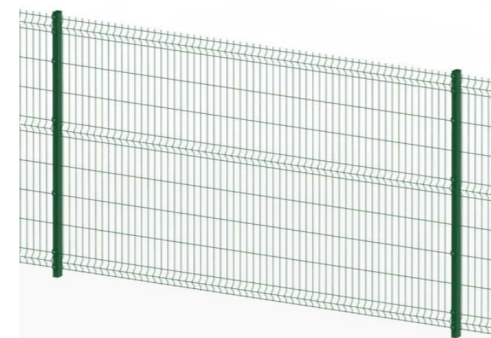
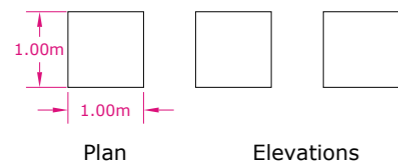

Proposed Fence Height 1.8m
Proposed Panel length 3.0m
(not to scale)

Proposed Gate Height 1.8m
(not to scale)



Units 3-5 Greystriars Business Park,
Frank Foley Way, Stafford, ST16 2ST
Tel: 01785 251555

Contains Ordnance Survey Data
(c) Crown copyright and database right 2022.
All rights reserved.
Licence number AL100004923

Revision:	Details:

Site: **SHORTWOOD PROPOSED LTP**

Title: **Tanks, Cabin & Fencing Details**

Drawn: TJG	Date: 6-7-23	Scale @A3: 1:100
---------------	-----------------	---------------------

Drawing number **Plan 4**