

M M
MOTT MACDONALD
Ordnance Survey Plan
Published 1971
Source map scale - 1:10,000

The historical maps shown were reproduced from maps predominantly held at the scale adopted for England, Wales and Scotland in the 1840's. In 1854 the 1:2,500 scale was adopted for mapping urban areas; these maps were used to update the 1:10,560 maps. The published date given therefore is often some years later than the surveyed date. Before 1938, all OS maps were based on the Cassini Projection, with independent surveys of a single county or group of counties, giving rise to significant inaccuracies in outlying areas. In the late 1940's, a Provisional Edition was produced, which updated the 1:10,560 mapping from a number of sources. The maps appear unfinished - with all military camps and other strategic sites removed. These maps were initially overprinted with the National Grid. In 1970, the first 1:10,000 maps were produced using the Transverse Mercator Projection. The revision process continued until recently, with new editions appearing every 10 years or so for urban areas.

Map Name(s) and Date(s)

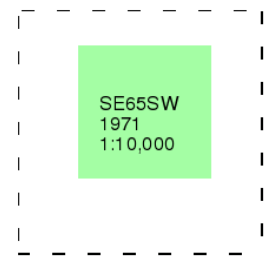

Historical Map - Slice A

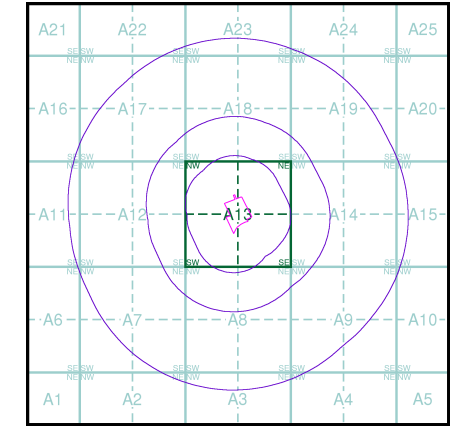

Order Details

Order Number: 285631777_1_1
 Customer Ref: 100418273 (note: to transfer to Hempland)
 National Grid Reference: 462570, 452930
 Slice: A
 Site Area (Ha): 2.22
 Search Buffer (m): 1000

Site Details

Hempland Primary ACADemy, Whitby Avenue, YORK, YO31 1ET

Landmark
 INFORMATION GROUP

Tel: 0844 844 9952
 Fax: 0844 844 9951
 Web: www.envirocheck.co.uk



M M
MOTT MACDONALD
York
Published 1980
Source map scale - 1:10,000

These maps were produced by the Russian military during the Cold War between 1950 and 1997, and cover 103 towns and cities throughout the U.K. The maps are produced at 1:25,000, 1:10,000 and 1:5,000 scale, and show detailed land use, with colour-coded areas for development, green areas, and non-developed areas. Buildings are coloured black and important building uses (such as hospitals, post offices, factories etc.) are numbered, with a numbered key describing their use. They were produced by the Russians for the benefit of navigation, as well as strategic military sites and transport hubs, for use if they were to have invaded the U.K. The detailed information provided indicates that the areas were surveyed using land-based personnel, on the ground, in the cities that are mapped.

Map Name(s) and Date(s)

SE65SW
 1980
 1:10,000

Russian Map - Slice A

Order Details
 Order Number: 285631777_1_1
 Customer Ref: 100418273 (note: to transfer to Hempland)
 National Grid Reference: 462570, 452930
 Slice: A
 Site Area (Ha): 2.22
 Search Buffer (m): 1000

Site Details
 Hempland Primary ACADemy, Whitby Avenue, YORK, YO31 1ET

Landmark
 INFORMATION GROUP

Tel: 0844 844 9952
 Fax: 0844 844 9951
 Web: www.envirocheck.co.uk

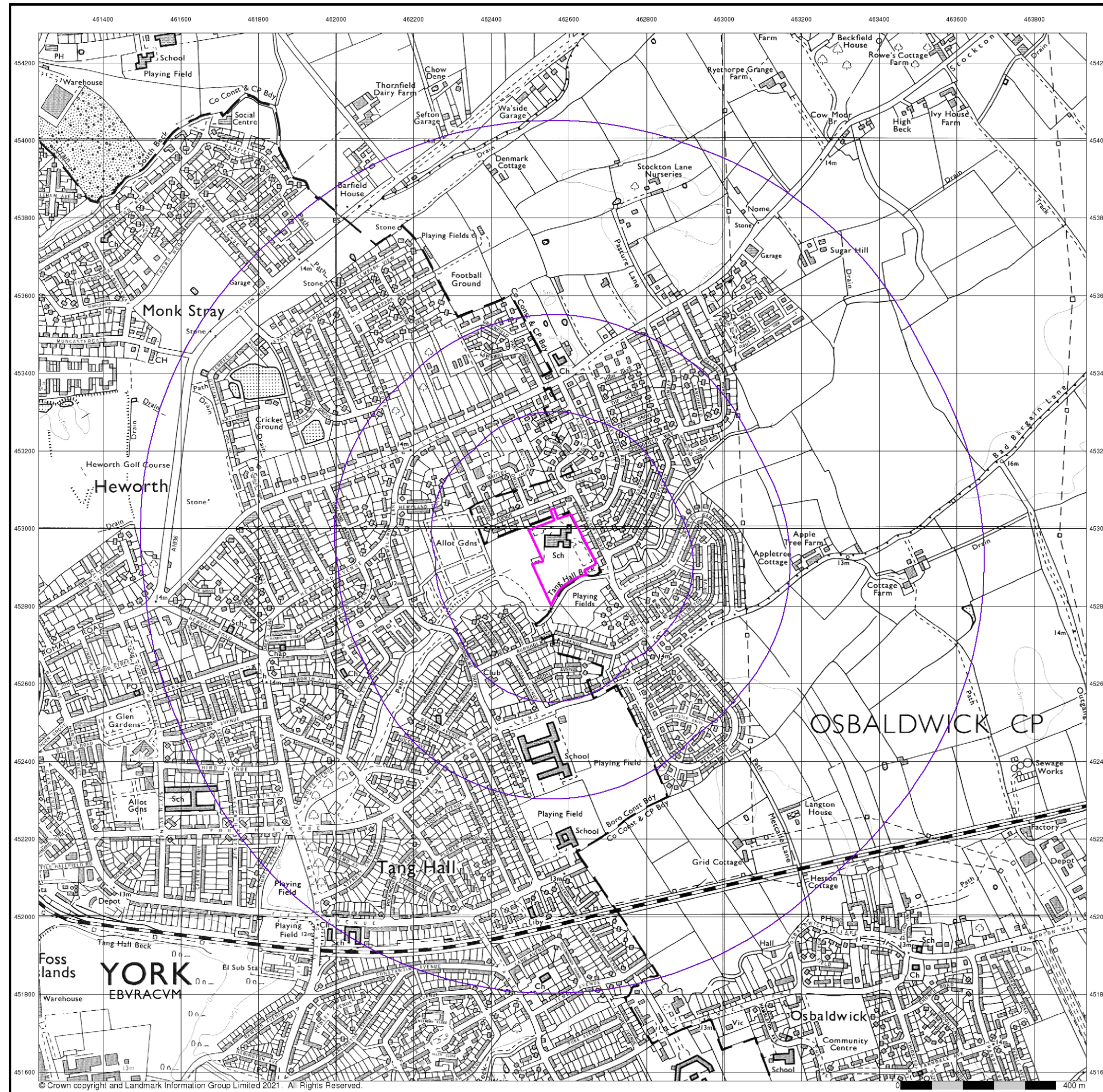

M M
MOTT MACDONALD
Ordnance Survey Plan
Published 1982
Source map scale - 1:10,000

The historical maps shown were reproduced from maps predominantly held at the scale adopted for England, Wales and Scotland in the 1840's. In 1854 the 1:2,500 scale was adopted for mapping urban areas; these maps were used to update the 1:10,560 maps. The published date given therefore is often some years later than the surveyed date. Before 1938, all OS maps were based on the Cassini Projection, with independent surveys of a single county or group of counties, giving rise to significant inaccuracies in outlying areas. In the late 1940's, a Provisional Edition was produced, which updated the 1:10,560 mapping from a number of sources. The maps appear unfinished - with all military camps and other strategic sites removed. These maps were initially overprinted with the National Grid. In 1970, the first 1:10,000 maps were produced using the Transverse Mercator Projection. The revision process continued until recently, with new editions appearing every 10 years or so for urban areas.

Map Name(s) and Date(s)

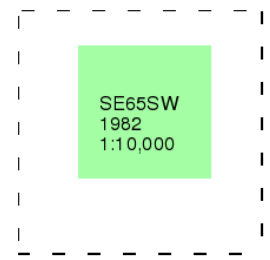

Historical Map - Slice A

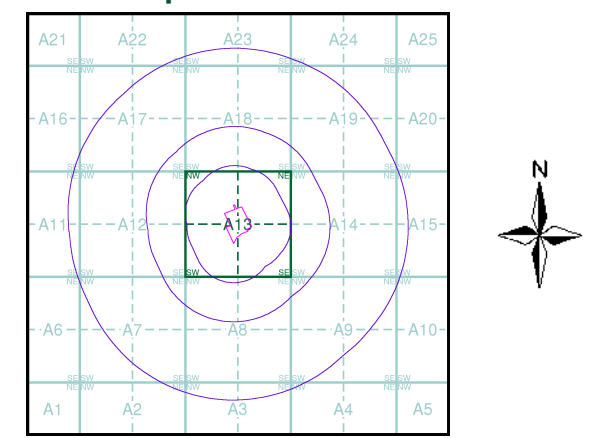

Order Details

Order Number: 285631777_1_1
 Customer Ref: 100418273 (note: to transfer to Hempland)
 National Grid Reference: 462570, 452930
 Slice: A
 Site Area (Ha): 2.22
 Search Buffer (m): 1000

Site Details
 Hempland Primary ACADemy, Whitby Avenue, YORK, YO31 1ET

Landmark
 INFORMATION GROUP

Tel: 0844 844 9952
 Fax: 0844 844 9951
 Web: www.envirocheck.co.uk



M M
MOTT MACDONALD
Ordnance Survey Plan
Published 1992
Source map scale - 1:10,000

The historical maps shown were reproduced from maps predominantly held at the scale adopted for England, Wales and Scotland in the 1840's. In 1854 the 1:2,500 scale was adopted for mapping urban areas; these maps were used to update the 1:10,560 maps. The published date given therefore is often some years later than the surveyed date. Before 1938, all OS maps were based on the Cassini Projection, with independent surveys of a single county or group of counties, giving rise to significant inaccuracies in outlying areas. In the late 1940's, a Provisional Edition was produced, which updated the 1:10,560 mapping from a number of sources. The maps appear unfinished - with all military camps and other strategic sites removed. These maps were initially overprinted with the National Grid. In 1970, the first 1:10,000 maps were produced using the Transverse Mercator Projection. The revision process continued until recently, with new editions appearing every 10 years or so for urban areas.

Map Name(s) and Date(s)

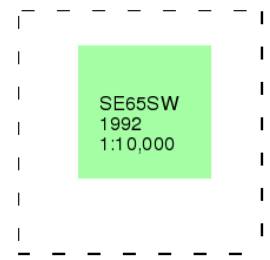

Historical Map - Slice A

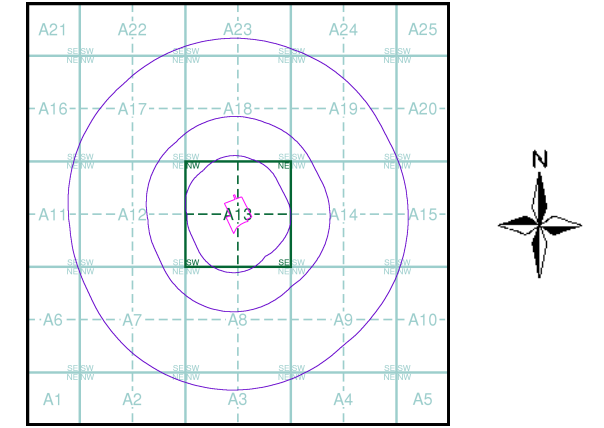

Order Details

Order Number: 285631777_1_1
 Customer Ref: 100418273 (note: to transfer to Hempland)
 National Grid Reference: 462570, 452930
 Slice: A
 Site Area (Ha): 2.22
 Search Buffer (m): 1000

Site Details

Hempland Primary ACADemy, Whitby Avenue, YORK, YO31 1ET

Landmark
 INFORMATION GROUP

Tel: 0844 844 9952
 Fax: 0844 844 9951
 Web: www.envirocheck.co.uk

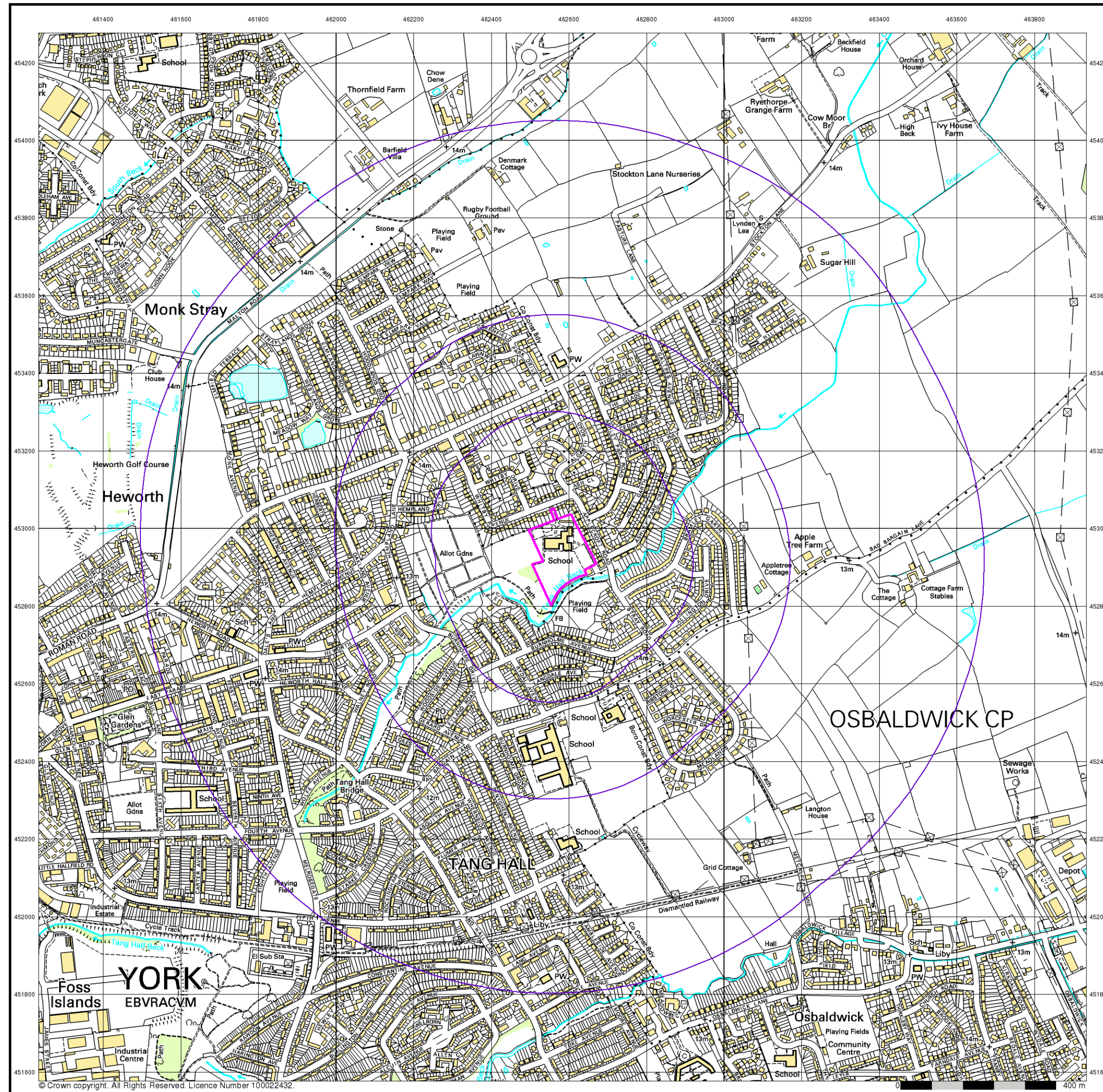

M M
MOTT MACDONALD
10k Raster Mapping
Published 1999
Source map scale - 1:10,000

The historical maps shown were produced from the Ordnance Survey's 1:10,000 colour raster mapping. These maps are derived from Landplan which replaced the old 1:10,000 maps originally published in 1970. The data is highly detailed showing buildings, fences and field boundaries as well as all roads, tracks and paths. Road names are also included together with the relevant road number and classification. Boundary information depiction includes county, unitary authority, district, civil parish and constituency.

Map Name(s) and Date(s)

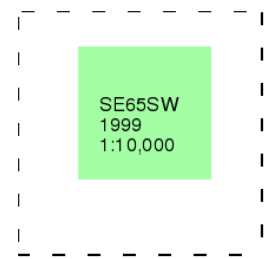

Historical Map - Slice A

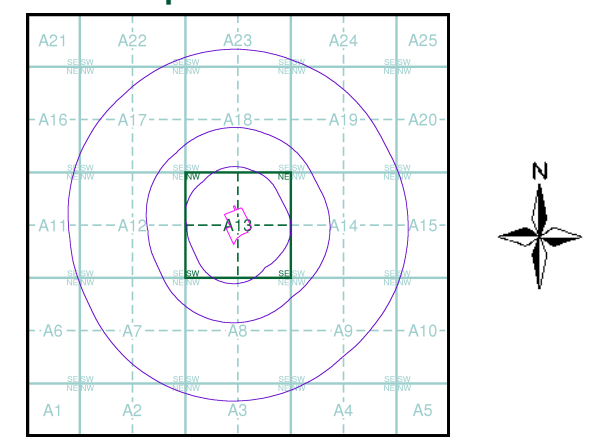

Order Details
 Order Number: 285631777_1_1
 Customer Ref: 100418273 (note: to transfer to Hempland)
 National Grid Reference: 462570, 452930
 Slice: A
 Site Area (Ha): 2.22
 Search Buffer (m): 1000

Site Details
 Hempland Primary ACADemy, Whitby Avenue, YORK, YO31 1ET

Landmark
 INFORMATION GROUP
 Tel: 0844 844 9952
 Fax: 0844 844 9951
 Web: www.envirocheck.co.uk

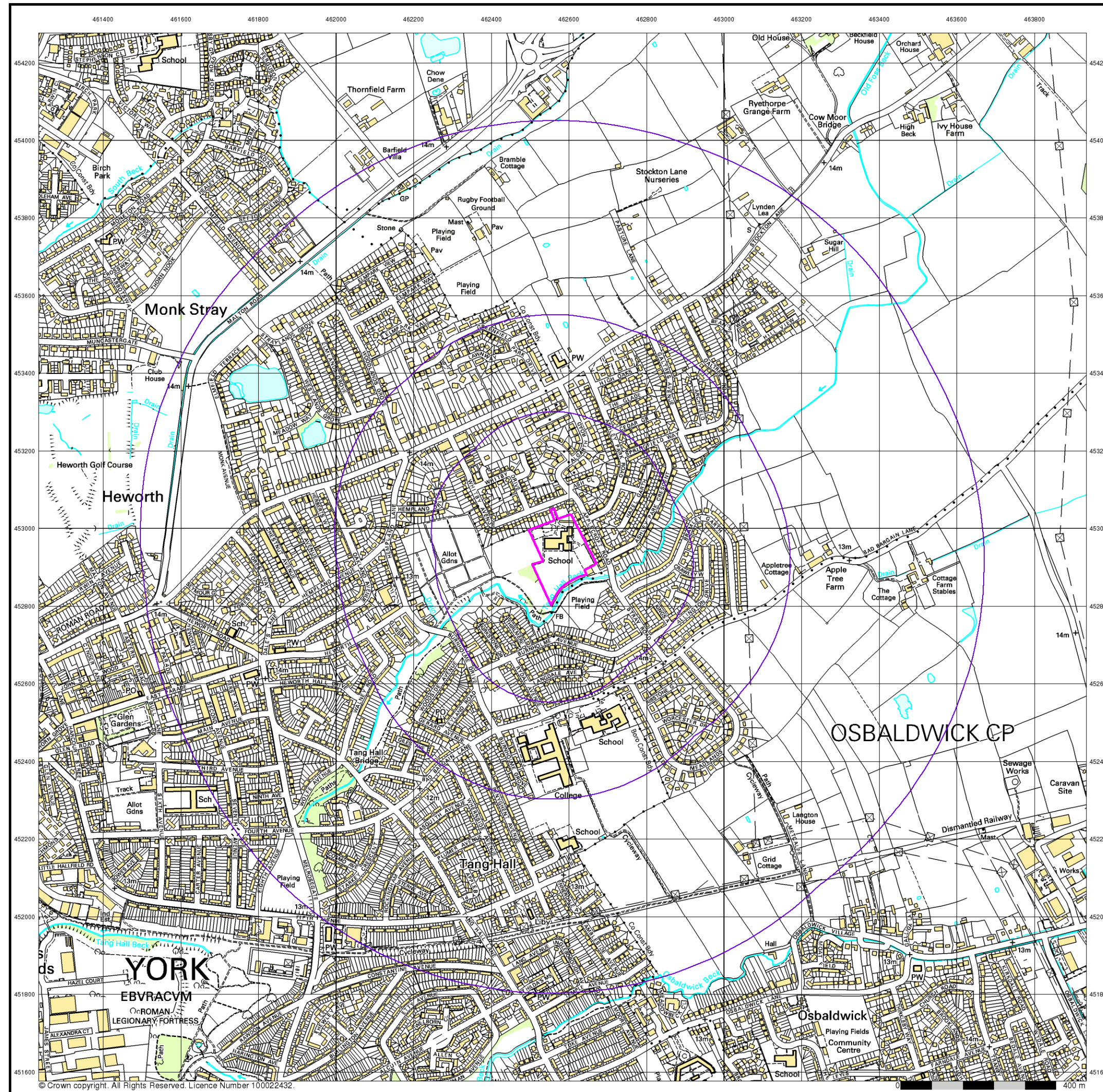

M M
MOTT MACDONALD
10k Raster Mapping
Published 2006
Source map scale - 1:10,000

The historical maps shown were produced from the Ordnance Survey's 1:10,000 colour raster mapping. These maps are derived from Landplan which replaced the old 1:10,000 maps originally published in 1970. The data is highly detailed showing buildings, fences and field boundaries as well as all roads, tracks and paths. Road names are also included together with the relevant road number and classification. Boundary information depiction includes county, unitary authority, district, civil parish and constituency.

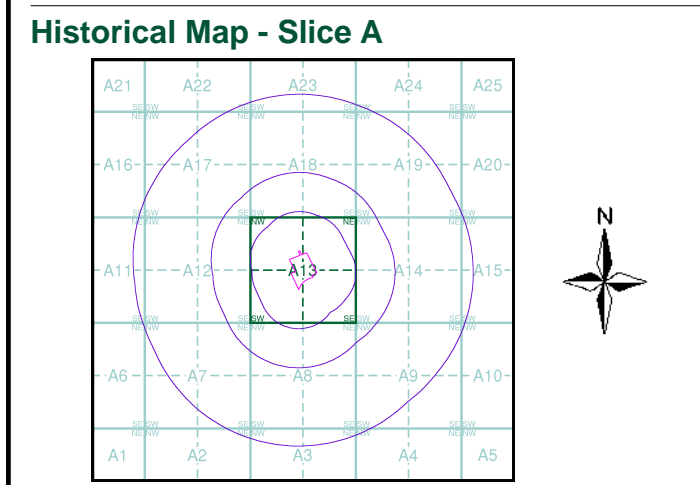
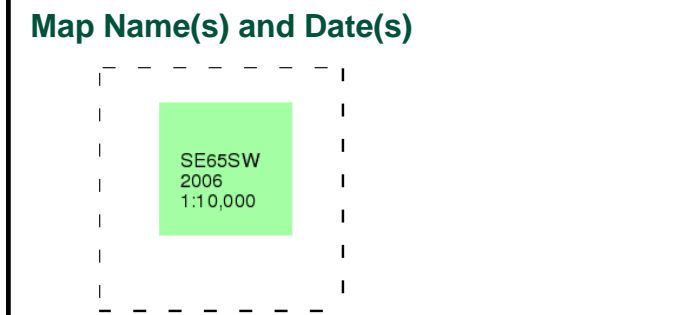

Order Details

Order Number: 285631777_1_1
 Customer Ref: 100418273 (note: to transfer to Hempland)
 National Grid Reference: 462570, 452930
 Slice: A
 Site Area (Ha): 2.22
 Search Buffer (m): 1000

Site Details

Hempland Primary ACADemy, Whitby Avenue, YORK, YO31 1ET

Landmark
 INFORMATION GROUP

Tel: 0844 844 9952
 Fax: 0844 844 9951
 Web: www.envirocheck.co.uk

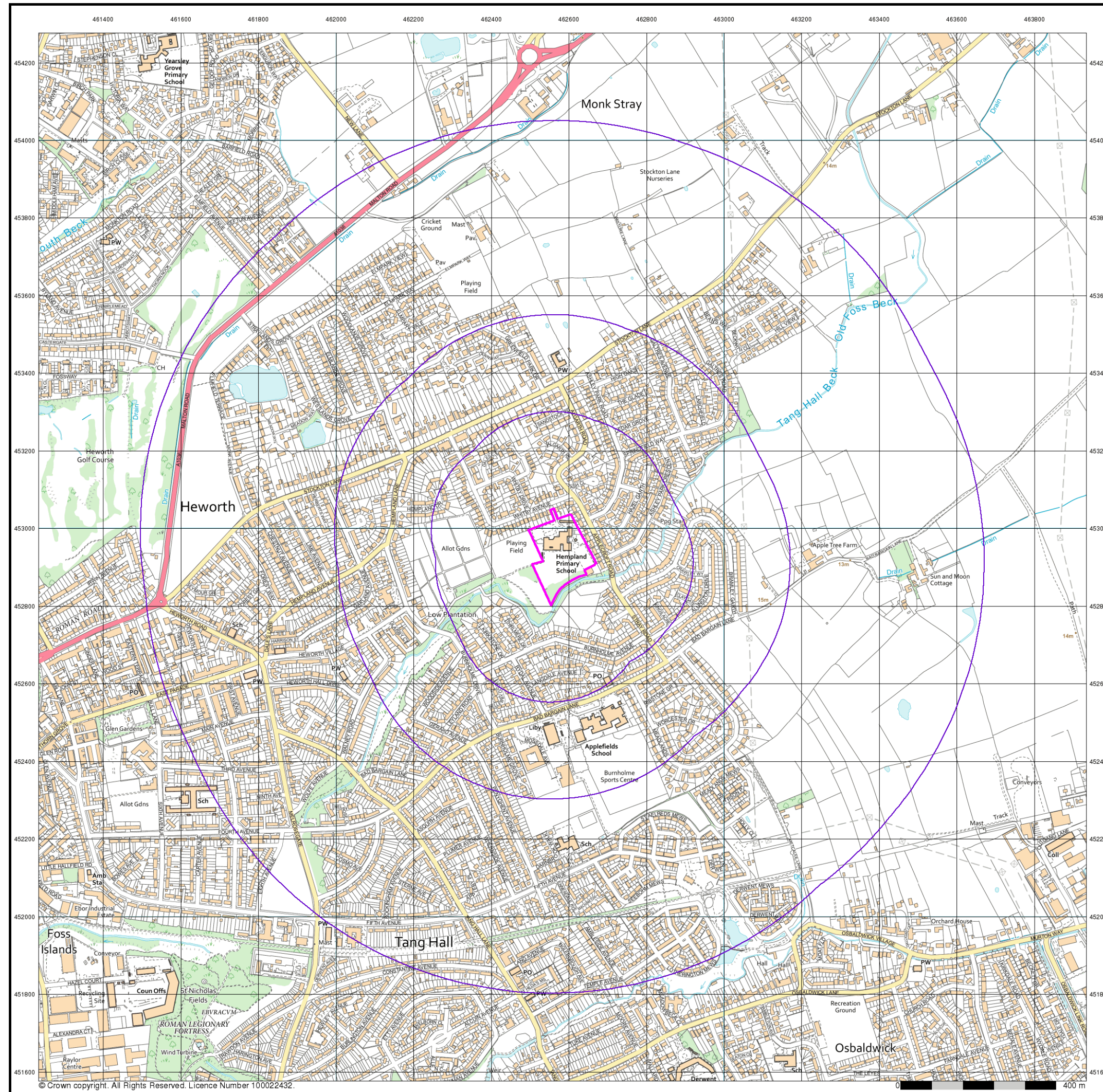

M M
MOTT MACDONALD
VectorMap Local
Published 2021
Source map scale - 1:10,000

VectorMap Local (Raster) is Ordnance Survey's highest detailed 'backdrop' mapping product. These maps are produced from OS's VectorMap Local, a simple vector dataset at a nominal scale of 1:10,000, covering the whole of Great Britain, that has been designed for creating graphical mapping. OS VectorMap Local is derived from large-scale information surveyed at 1:1250 scale (covering major towns and cities), 1:2500 scale (smaller towns, villages and developed rural areas), and 1:10 000 scale (mountain, moorland and river estuary areas).

Map Name(s) and Date(s)

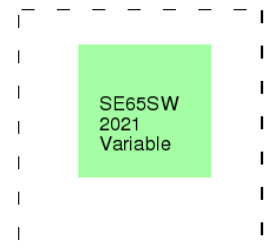

Historical Map - Slice A

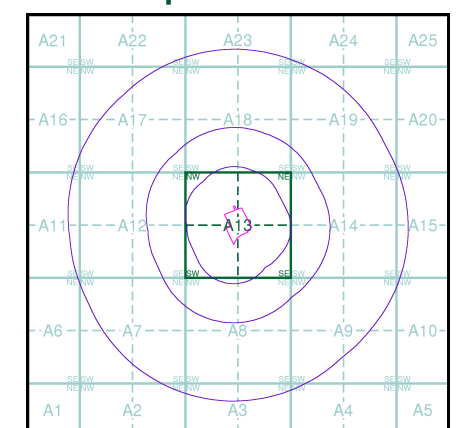

Order Details

Order Number: 285631777_1_1
 Customer Ref: 100418273 (note: to transfer to Hempland)
 National Grid Reference: 462570, 452930
 Slice: A
 Site Area (Ha): 2.22
 Search Buffer (m): 1000

Site Details

Hempland Primary ACADemy, Whitby Avenue, YORK, YO31 1ET

Landmark
 INFORMATION GROUP

Tel: 0844 844 9952
 Fax: 0844 844 9951
 Web: www.envirocheck.co.uk

Historical Mapping Legends

Ordnance Survey County Series and Ordnance Survey Plan 1:2,500

Quarry **Gravel Pit** **Sand Pit**
Clay Pit **Shingle** **Refuse Heap**
Sloping Masonry **Flat Rock**
Marsh **Reeds** **Osiers**
Rough Pasture **Furze** **Wood**
Mixed Wood **Brushwood** **Orchard**
Fir **Ford** **Stepping Stones**
Ferry **Waterfall** **Lock**
Trig. Station **Altitude at Trig. Station**
B.M. 325.9 **Bench Mark** **Surface Level**
Arrow denotes flow of water **Antiquities (site of)**
Cutting **Embankment**
Railway crossing Road **Level Crossing** **Road crossing Railway**
Railway crossing River or Canal **Road over single stream** **Road over River or Canal**
County Boundary (Geographical)
County & Civil Parish Boundary
Administrative County & Civil Parish Boundary
County Borough Boundary (England)
Co. Boro. Bdy.
County Burgh Boundary (Scotland)
Boundary Post or Stone **Police Call Box**
B.R. **Bridle Road** **P** **Pump**
E.P. **Electricity Pylon** **S.P.** **Signal Post**
F.B. **Foot Bridge** **Sl.** **Sluice**
F.P. **Foot Path** **Sp.** **Spring**
G.P. **Guide Post or Board** **T.C.B.** **Telephone Call Box**
M.S. **Mile Stone** **Tr.** **Trough**
M.P. M.R. **Mooring Post or Ring** **W** **Well**

Ordnance Survey Plan, Additional SIMs and Supply of Unpublished Survey Information 1:2,500 and 1:1,250

Inactive Quarry, Chalk Pit or Clay Pit **Active Quarry, Chalk Pit or Clay Pit**
Rock **Boulders**
Cliff **Slopes** **Top**
Roofed Building **Glazed Roof Building**
Sloping Masonry **Archway**
Non-Coniferous Tree (surveyed) **Coniferous Tree (surveyed)**
Non-Coniferous Trees (not surveyed) **Coniferous Trees (not surveyed)**
Orchard Tree **Scrub** **Bracken**
Coppice, Osier **Reeds** **Marsh, Saltings**
Rough Grassland **Heath** **Culvert**
Direction of water flow **Bench Mark** **Antiquity (site of)**
Cave Entrance **Triangulation Station** **Electricity Pylon**
Electricity Transmission Line
County Boundary (Geographical)
County & Civil Parish Boundary
Civil Parish Boundary
Admin. County or County Bor. Boundary
London Borough Boundary
Symbol marking point where boundary mereing changes
BH **Beer House** **P** **Pillar, Pole or Post**
BP, BS **Boundary Post or Stone** **PO** **Post Office**
Cn, C **Capstan, Crane** **PC** **Public Convenience**
Chy **Chimney** **PH** **Public House**
D Fn **Drinking Fountain** **Pp** **Pump**
EI P **Electricity Pillar or Post** **SB, S Br** **Signal Box or Bridge**
FAP **Fire Alarm Pillar** **SP, SL** **Signal Post or Light**
FB **Foot Bridge** **Spr** **Spring**
GP **Guide Post** **Tk** **Tank or Track**
H **Hydrant or Hydraulic** **TCB** **Telephone Call Box**
LC **Level Crossing** **TCP** **Telephone Call Post**
MH **Manhole** **Tr** **Trough**
MP **Mile Post or Mooring Post** **Wr Pt, Wr T** **Water Point, Water Tap**
MS **Mile Stone** **W** **Well**
NTL **Normal Tidal Limit** **Wd Pp** **Wind Pump**

Large-Scale National Grid Data 1:2,500 and 1:1,250

Cliff **Slopes** **Top**
Rock **Rock (scattered)**
Boulders **Boulders (scattered)**
Positioned Boulder **Scree**
Non-Coniferous Tree (surveyed) **Coniferous Tree (surveyed)**
Non-Coniferous Trees (not surveyed) **Coniferous Trees (not surveyed)**
Orchard Tree **Scrub** **Bracken**
Coppice, Osier **Reeds** **Marsh, Saltings**
Rough Grassland **Heath** **Culvert**
Direction of water flow **Triangulation Station** **Antiquity (site of)**
Electricity Transmission Line **Electricity Pylon**
B.M. 231.60m **Bench Mark** **Buildings with Building Seed**
Roofed Building **Glazed Roof Building**
Civil parish/community boundary
District boundary
County boundary
Boundary post/stone
Boundary mereing symbol (note: these always appear in opposed pairs or groups of three)
Bks **Barracks** **P** **Pillar, Pole or Post**
Bty **Battery** **PO** **Post Office**
Cemy **Cemetery** **PC** **Public Convenience**
Chy **Chimney** **Pp** **Pump**
Cis **Cistern** **Ppg Sta** **Pumping Station**
Dismtd Rly **Dismantled Railway** **PW** **Place of Worship**
EI Gen Sta **Electricity Generating Station** **Sewage Ppg Sta** **Sewage Pumping Station**
EI P **Electricity Pole, Pillar** **SB, S Br** **Signal Box or Bridge**
EI Sub Sta **Electricity Sub Station** **SP, SL** **Signal Post or Light**
FB **Filter Bed** **Spr** **Spring**
Fn / D Fn **Fountain / Drinking Ftn.** **Tk** **Tank or Track**
Gas Gov **Gas Valve Compound** **Tr** **Trough**
GVC **Gas Governor** **Wd Pp** **Wind Pump**
GP **Guide Post** **Wr Pt, Wr T** **Water Point, Water Tap**
MH **Manhole** **Wks** **Works (building or area)**
MP, MS **Mile Post or Mile Stone** **W** **Well**

M M MOTT MACDONALD Historical Mapping & Photography included:

Mapping Type	Scale	Date	Pg
Yorkshire	1:2,500	1890 - 1892	2
Yorkshire	1:2,500	1909	3
Yorkshire	1:2,500	1930 - 1931	4
Yorkshire	1:2,500	1937	5
Ordnance Survey Plan	1:1,250	1961	6
Ordnance Survey Plan	1:1,250	1966 - 1974	7
Additional SIMs	1:1,250	1966 - 1991	8
Ordnance Survey Plan	1:2,500	1967	9
Additional SIMs	1:1,250	1988 - 1992	10
Additional SIMs	1:1,250	1991	11
Large-Scale National Grid Data	1:1,250	1993	12
Historical Aerial Photography	1:2,500	1999	13

Historical Map - Segment A13

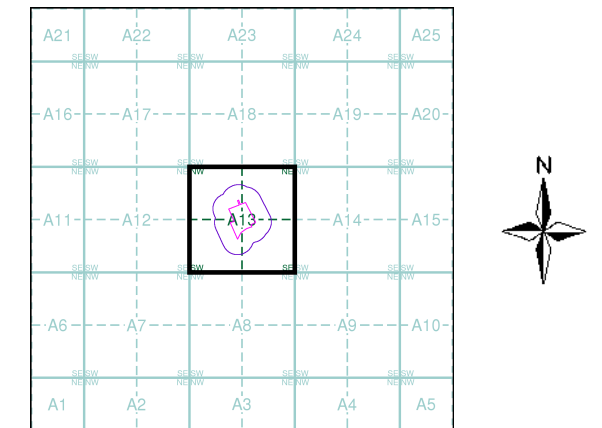

Order Details
 Order Number: 285631777_1_1
 Customer Ref: 100418273 (note: to transfer to Hempland)
 National Grid Reference: 462570, 452930
 Slice: A
 Site Area (Ha): 2.22
 Search Buffer (m): 100

Site Details
 Hempland Primary ACADemy, Whitby Avenue, YORK, YO31 1ET

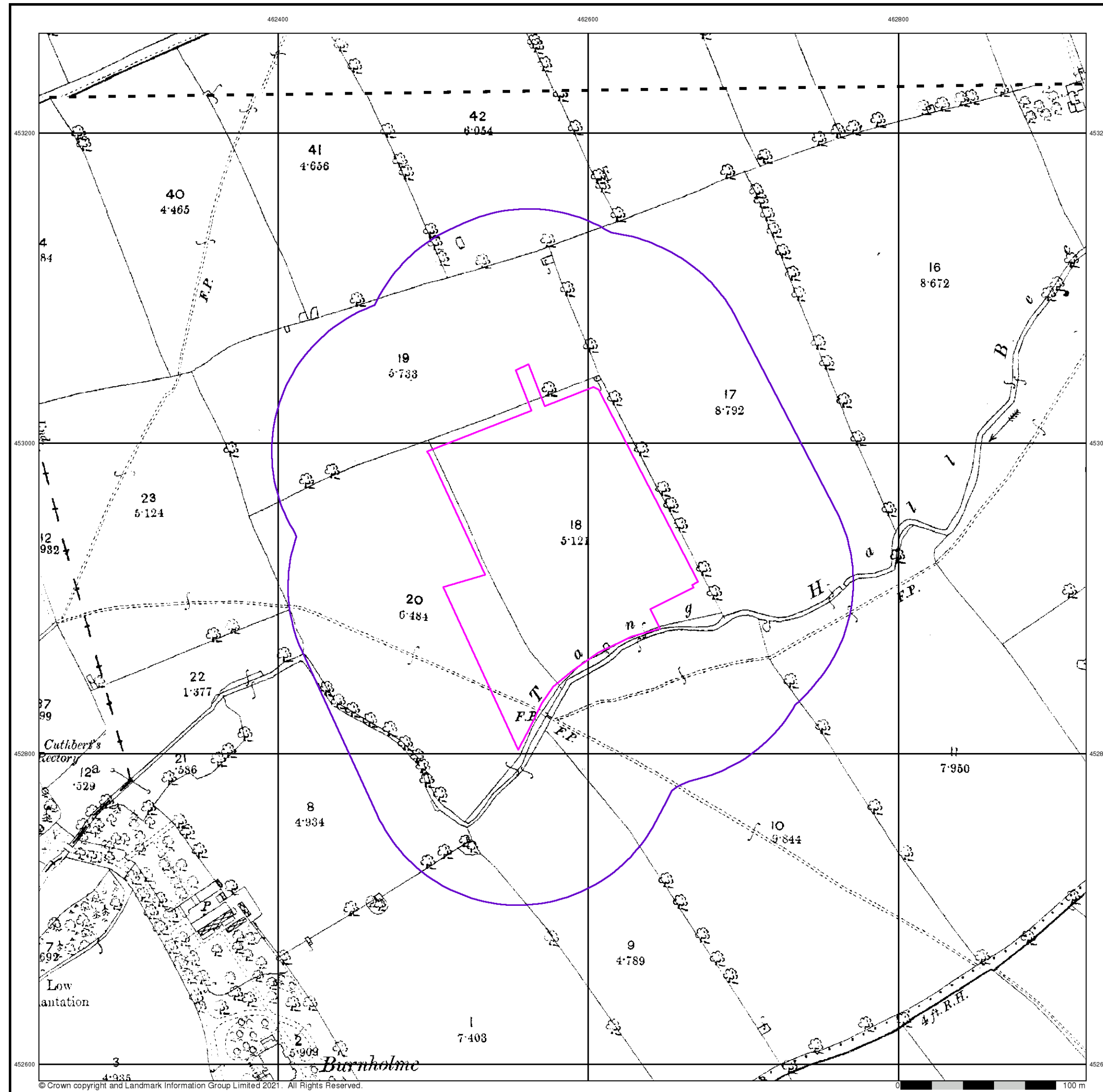

M M
MOTT MACDONALD
Yorkshire
Published 1890 - 1892
Source map scale - 1:2,500

The historical maps shown were reproduced from maps predominantly held at the scale adopted for England, Wales and Scotland in the 1840's. In 1854 the 1:2,500 scale was adopted for mapping urban areas and by 1896 it covered the whole of what were considered to be the cultivated parts of Great Britain. The published date given below is often some years later than the surveyed date. Before 1938, all OS maps were based on the Cassini Projection, with independent surveys of a single county or group of counties, giving rise to significant inaccuracies in outlying areas.

Map Name(s) and Date(s)

174_03	1890	1:2,500
174_07	1892	1:2,500

Historical Map - Segment A13

Order Details

Order Number: 285631777_1_1
 Customer Ref: 100418273 (note: to transfer to Hempland)
 National Grid Reference: 462570, 452930
 Slice: A
 Site Area (Ha): 2.22
 Search Buffer (m): 100

Site Details

Hempland Primary ACADemy, Whitby Avenue, YORK, YO31 1ET

Landmark
 INFORMATION GROUP

Tel: 0844 844 9952
 Fax: 0844 844 9951
 Web: www.envirocheck.co.uk

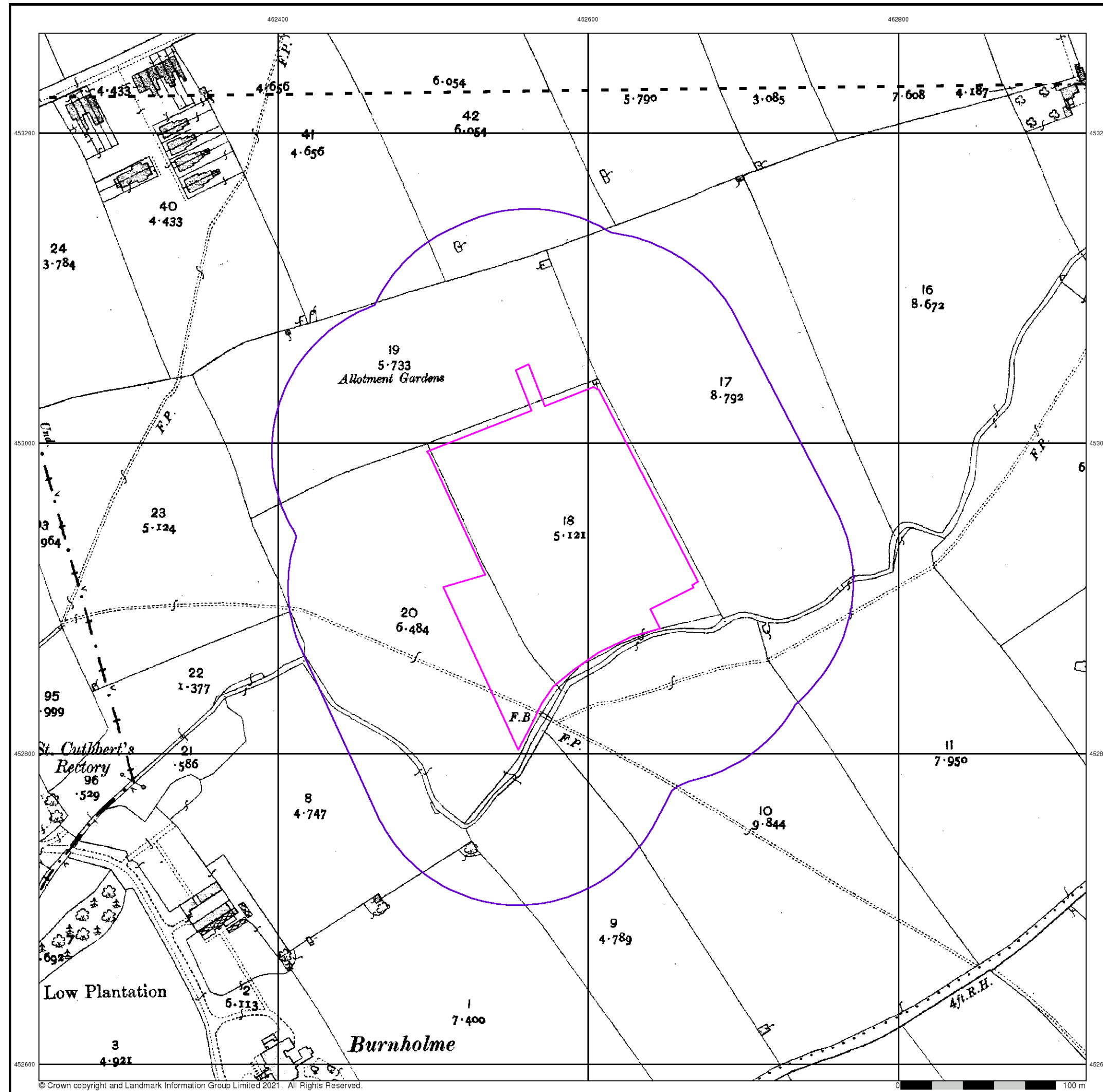

M M
MOTT MACDONALD
Yorkshire
Published 1909
Source map scale - 1:2,500

The historical maps shown were reproduced from maps predominantly held at the scale adopted for England, Wales and Scotland in the 1840's. In 1854 the 1:2,500 scale was adopted for mapping urban areas and by 1896 it covered the whole of what were considered to be the cultivated parts of Great Britain. The published date given below is often some years later than the surveyed date. Before 1938, all OS maps were based on the Cassini Projection, with independent surveys of a single county or group of counties, giving rise to significant inaccuracies in outlying areas.

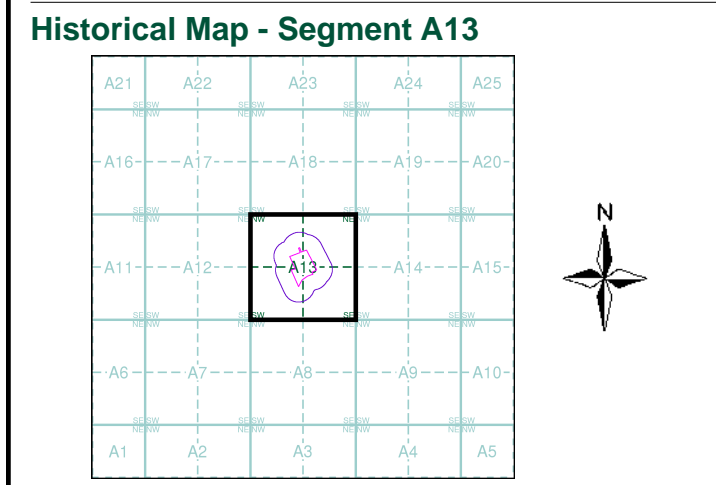
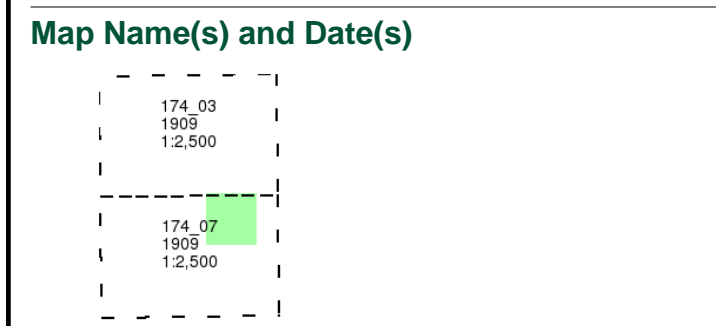

Order Details
Order Number: 285631777_1_1
Customer Ref: 100418273 (note: to transfer to Hempland)
National Grid Reference: 462570, 452930
Slice: A
Site Area (Ha): 2.22
Search Buffer (m): 100

Site Details
Hempland Primary ACADemy, Whitby Avenue, YORK, YO31 1ET

Landmark
INFORMATION GROUP

Tel: 0844 844 9952
Fax: 0844 844 9951
Web: www.envirocheck.co.uk

© Crown copyright and Landmark Information Group Limited 2021. All Rights Reserved.

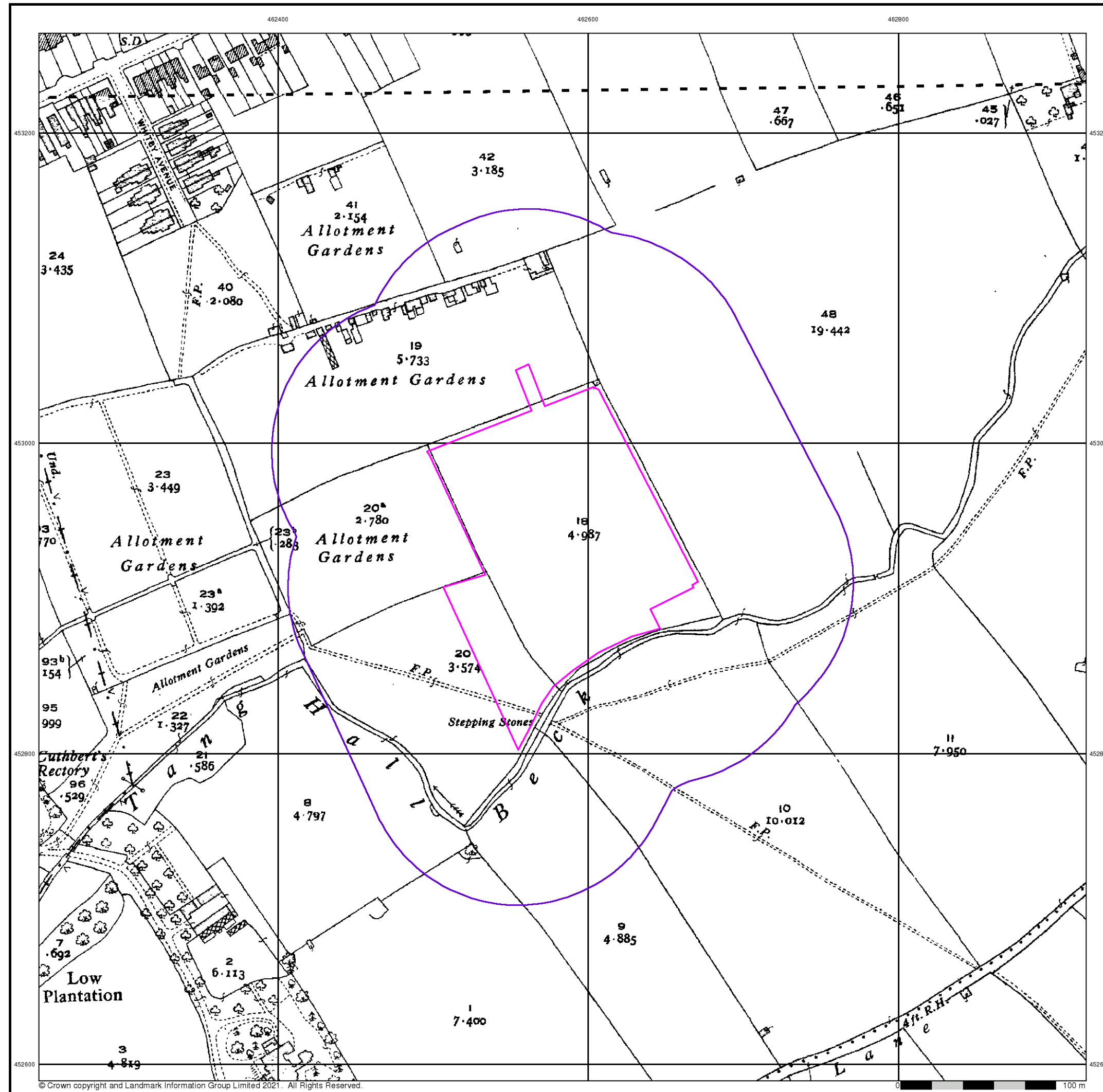

M M
MOTT MACDONALD
Yorkshire
Published 1930 - 1931
Source map scale - 1:2,500

The historical maps shown were reproduced from maps predominantly held at the scale adopted for England, Wales and Scotland in the 1840's. In 1854 the 1:2,500 scale was adopted for mapping urban areas and by 1896 it covered the whole of what were considered to be the cultivated parts of Great Britain. The published date given below is often some years later than the surveyed date. Before 1938, all OS maps were based on the Cassini Projection, with independent surveys of a single county or group of counties, giving rise to significant inaccuracies in outlying areas.

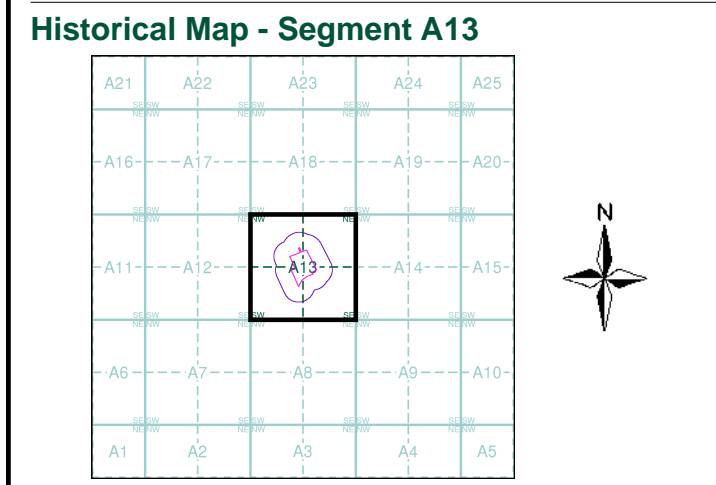
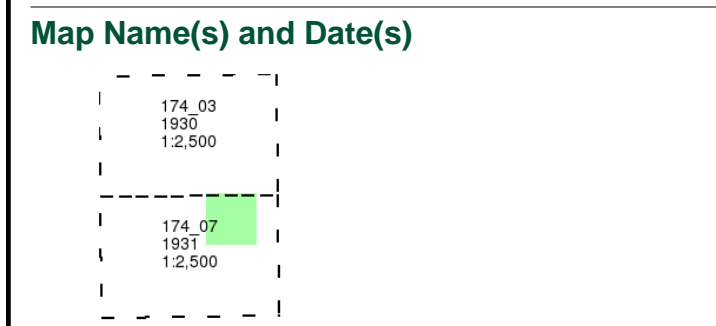

Order Details

Order Number: 285631777_1_1
 Customer Ref: 100418273 (note: to transfer to Hempland)
 National Grid Reference: 462570, 452930
 Slice: A
 Site Area (Ha): 2.22
 Search Buffer (m): 100

Site Details

Hempland Primary ACADemy, Whitby Avenue, YORK, YO31 1ET

Landmark
 INFORMATION GROUP

Tel: 0844 844 9952
 Fax: 0844 844 9951
 Web: www.envirocheck.co.uk

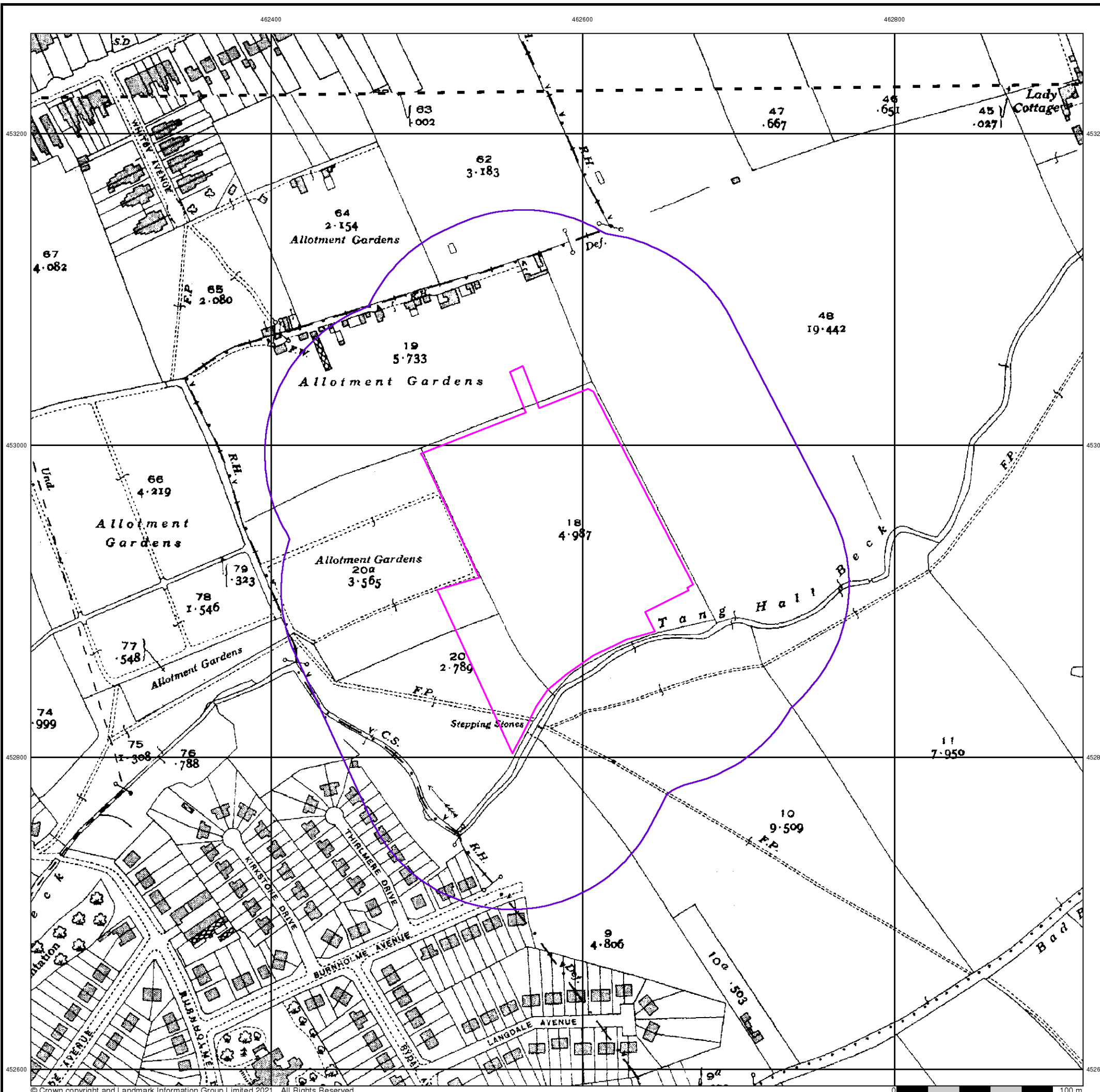

M M
MOTT MACDONALD
Yorkshire
Published 1937
Source map scale - 1:2,500

The historical maps shown were reproduced from maps predominantly held at the scale adopted for England, Wales and Scotland in the 1840's. In 1854 the 1:2,500 scale was adopted for mapping urban areas and by 1896 it covered the whole of what were considered to be the cultivated parts of Great Britain. The published date given below is often some years later than the surveyed date. Before 1938, all OS maps were based on the Cassini Projection, with independent surveys of a single county or group of counties, giving rise to significant inaccuracies in outlying areas.

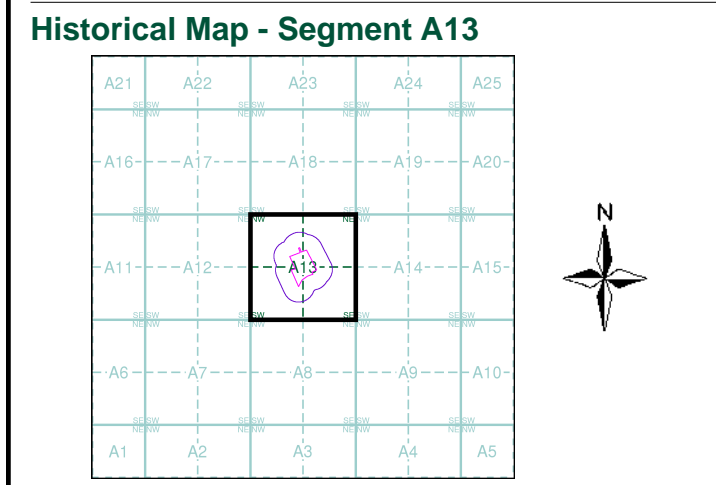
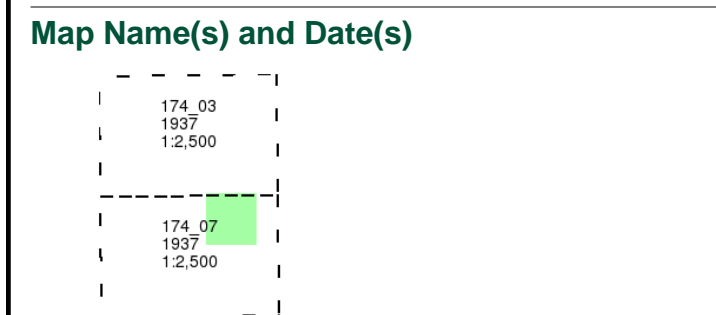

Order Details

Order Number: 285631777_1_1
 Customer Ref: 100418273 (note: to transfer to Hempland)
 National Grid Reference: 462570, 452930
 Slice: A
 Site Area (Ha): 2.22
 Search Buffer (m): 100

Site Details

Hempland Primary ACADemy, Whitby Avenue, YORK, YO31 1ET

Landmark
 INFORMATION GROUP

Tel: 0844 844 9952
 Fax: 0844 844 9951
 Web: www.envirocheck.co.uk

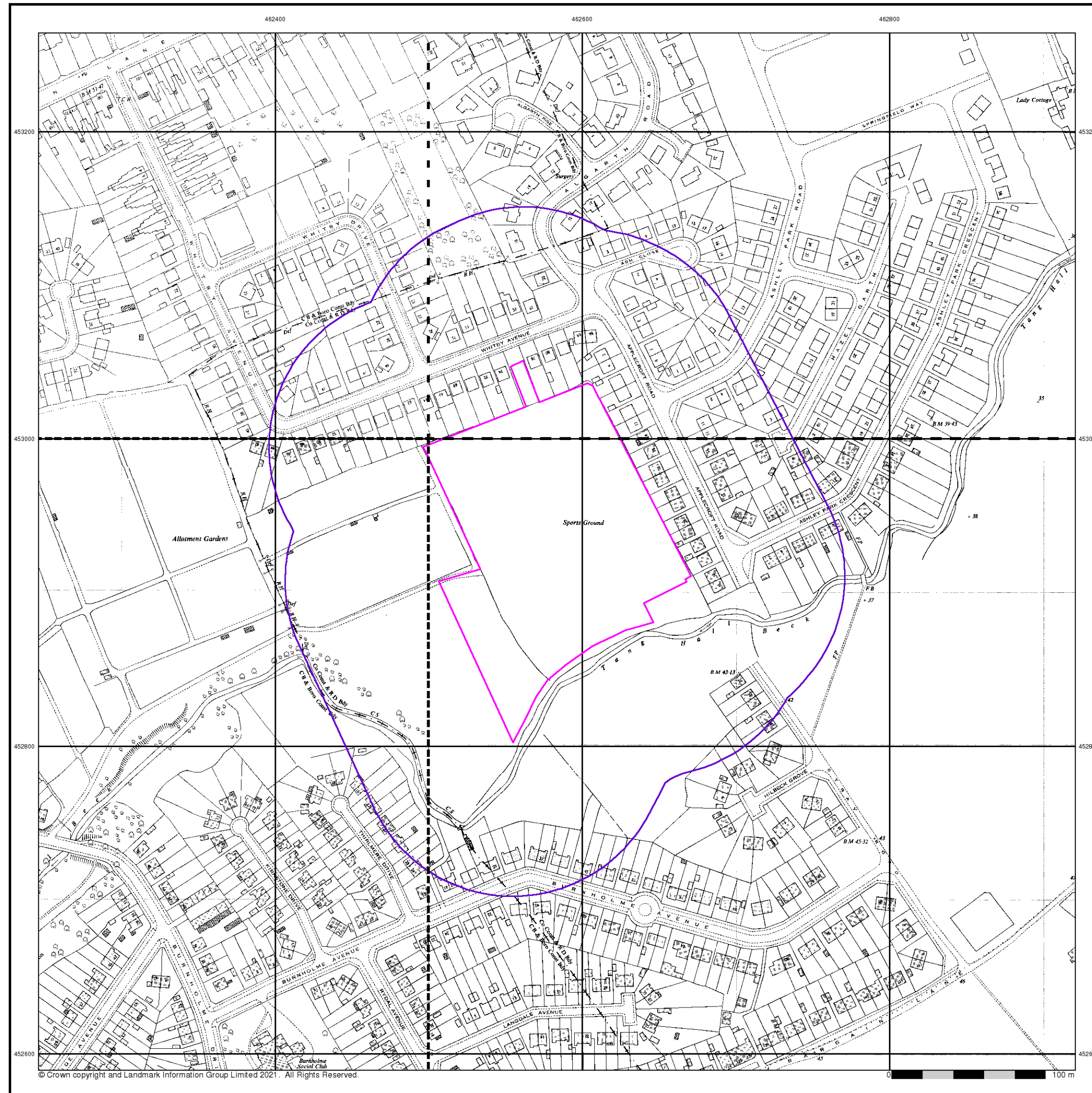

M M
MOTT MACDONALD
Ordnance Survey Plan
Published 1961
Source map scale - 1:1,250

The historical maps shown were reproduced from maps predominantly held at the scale adopted for England, Wales and Scotland in the 1840's. In 1854 the 1:2,500 scale was adopted for mapping urban areas and by 1896 it covered the whole of what were considered to be the cultivated parts of Great Britain. The published date given below is often some years later than the surveyed date. Before 1938, all OS maps were based on the Cassini Projection, with independent surveys of a single county or group of counties, giving rise to significant inaccuracies in outlying areas.

Map Name(s) and Date(s)

SE 6253SW 1961 1:1,250	SE 6253SE 1961 1:1,250
SE 6252NW 1961 1:1,250	SE 6252NE 1961 1:1,250

Historical Map - Segment A13

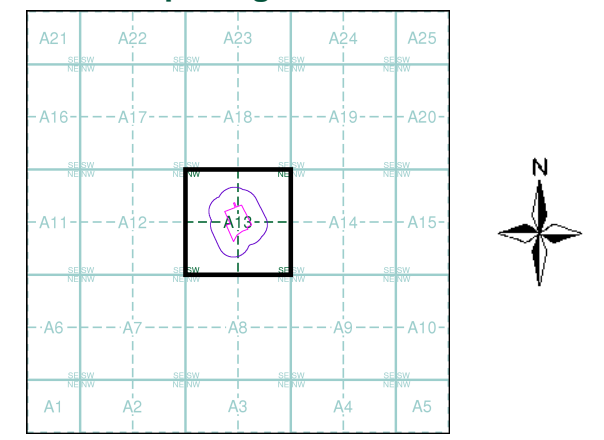

Order Details
Order Number: 285631777_1_1
Customer Ref: 100418273 (note: to transfer to Hempland)
National Grid Reference: 462570, 452930
Slice: A
Site Area (Ha): 2.22
Search Buffer (m): 100

Site Details
Hempland Primary ACADemy, Whitby Avenue, YORK, YO31 1ET

Landmark
INFORMATION GROUP
Tel: 0844 844 9952
Fax: 0844 844 9951
Web: www.envirocheck.co.uk

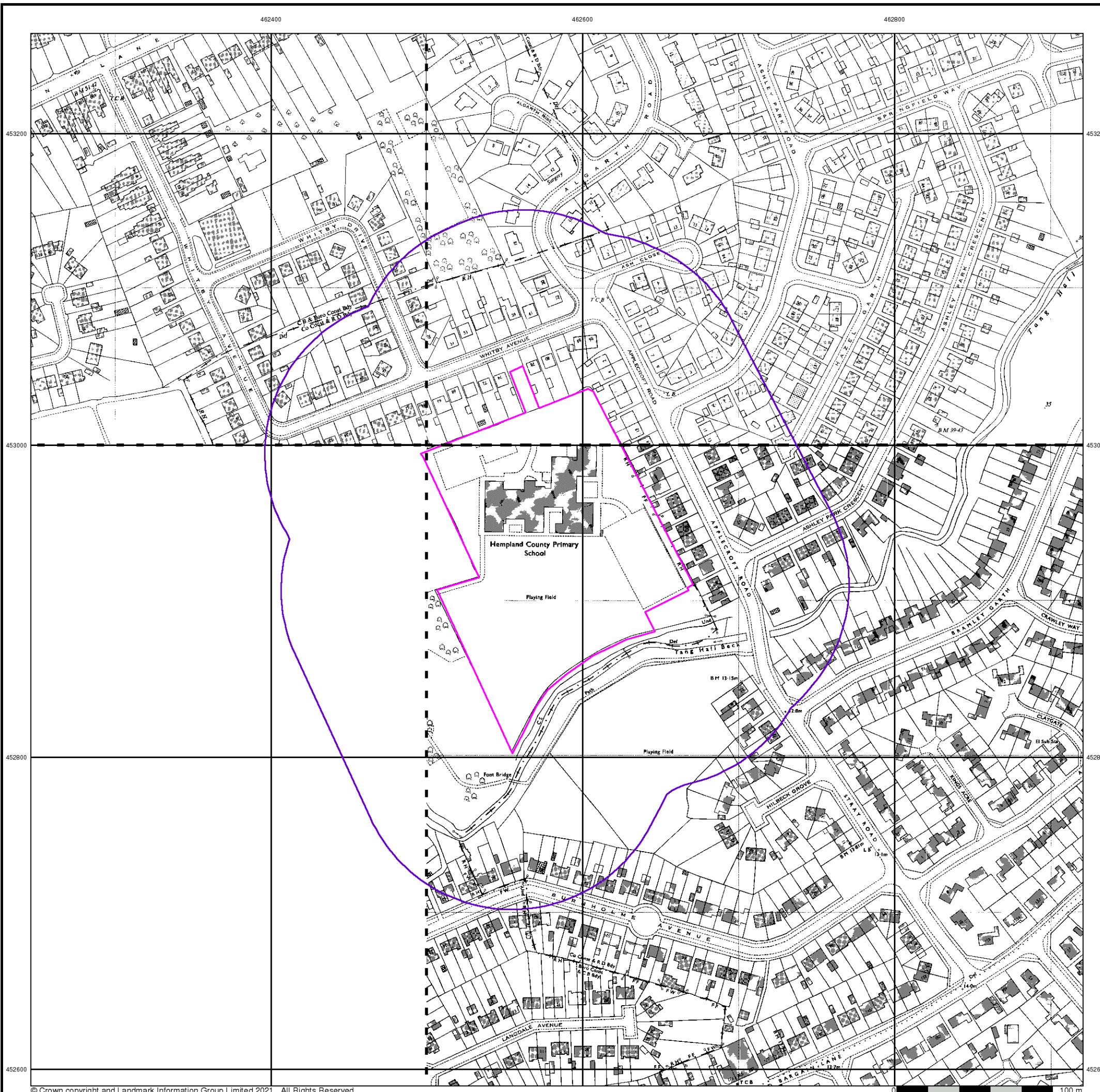

M M
MOTT MACDONALD
Ordnance Survey Plan
Published 1966 - 1974
Source map scale - 1:1,250

The historical maps shown were reproduced from maps predominantly held at the scale adopted for England, Wales and Scotland in the 1840's. In 1854 the 1:2,500 scale was adopted for mapping urban areas and by 1896 it covered the whole of what were considered to be the cultivated parts of Great Britain. The published date given below is often some years later than the surveyed date. Before 1938, all OS maps were based on the Cassini Projection, with independent surveys of a single county or group of counties, giving rise to significant inaccuracies in outlying areas.

Map Name(s) and Date(s)

SE 6253SW 1966 1:1,250	SE 6253SE 1966 1:1,250
SE 6252NE 1974 1:1,250	

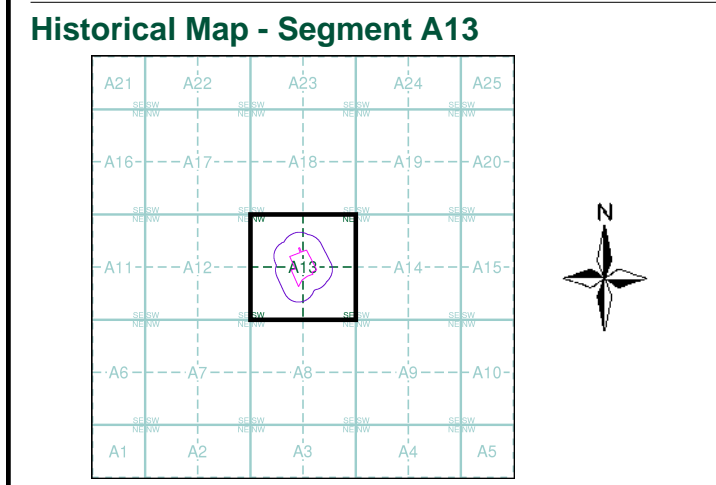

Order Details
Order Number: 285631777_1_1
Customer Ref: 100418273 (note: to transfer to Hempland)
National Grid Reference: 462570, 452930
Slice: A
Site Area (Ha): 2.22
Search Buffer (m): 100

Site Details
Hempland Primary ACADemy, Whitby Avenue, YORK, YO31 1ET

Landmark
INFORMATION GROUP

Tel: 0844 844 9952
Fax: 0844 844 9951
Web: www.envirocheck.co.uk

462400

462600

462800

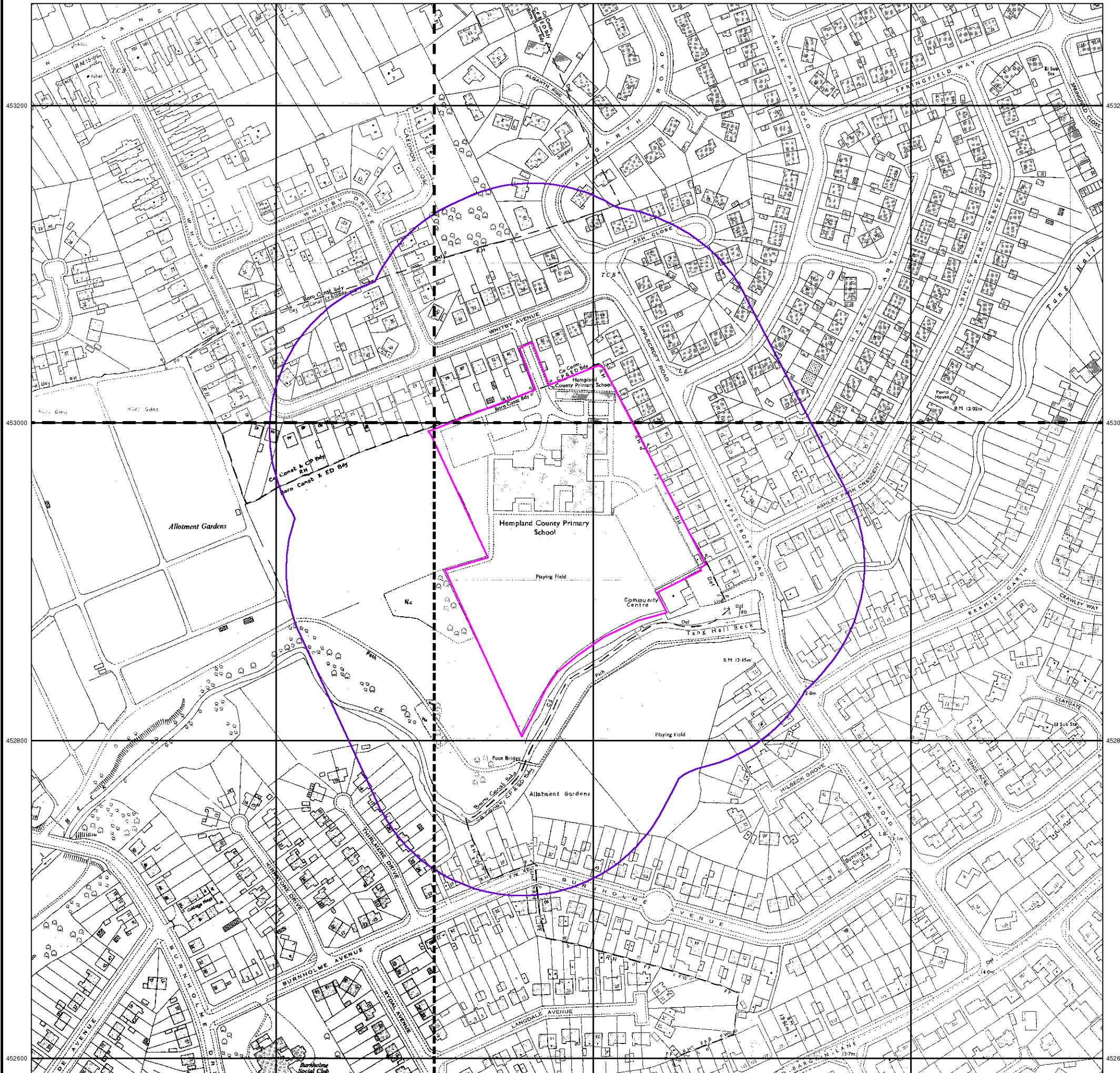

M
M
 MOTT
 MACDONALD

Additional SIMs

Published 1966 - 1991

Source map scale - 1:1,250

The SIM cards (Ordnance Survey's 'Survey of Information on Microfilm') are further, minor editions of mapping which were produced and published in between the main editions as an area was updated. They date from 1947 to 1994, and contain detailed information on buildings, roads and land-use. These maps were produced at both 1:2,500 and 1:1,250 scales.

Map Name(s) and Date(s)

SE 6253SW 1991 1:1,250	SE 6253SE 1966 1:1,250
SE 6252NW 1984 1:1,250	SE 6252NE 1991 1:1,250

Historical Map - Segment A13

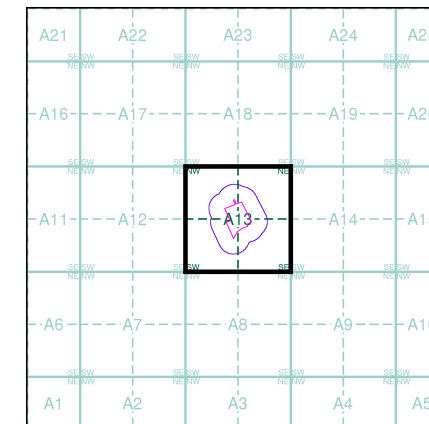

Order Details

Order Number: 285631777_1_1
 Customer Ref: 100418273 (note: to transfer to Hempland)
 National Grid Reference: 462570, 452930
 Slice: A
 Site Area (Ha): 2.22
 Search Buffer (m): 100

Site Details

Hempland Primary ACADemy, Whitby Avenue, YORK, YO31 1ET

Landmark
 INFORMATION GROUP

Tel: 0844 844 9952
 Fax: 0844 844 9951
 Web: www.envirocheck.co.uk

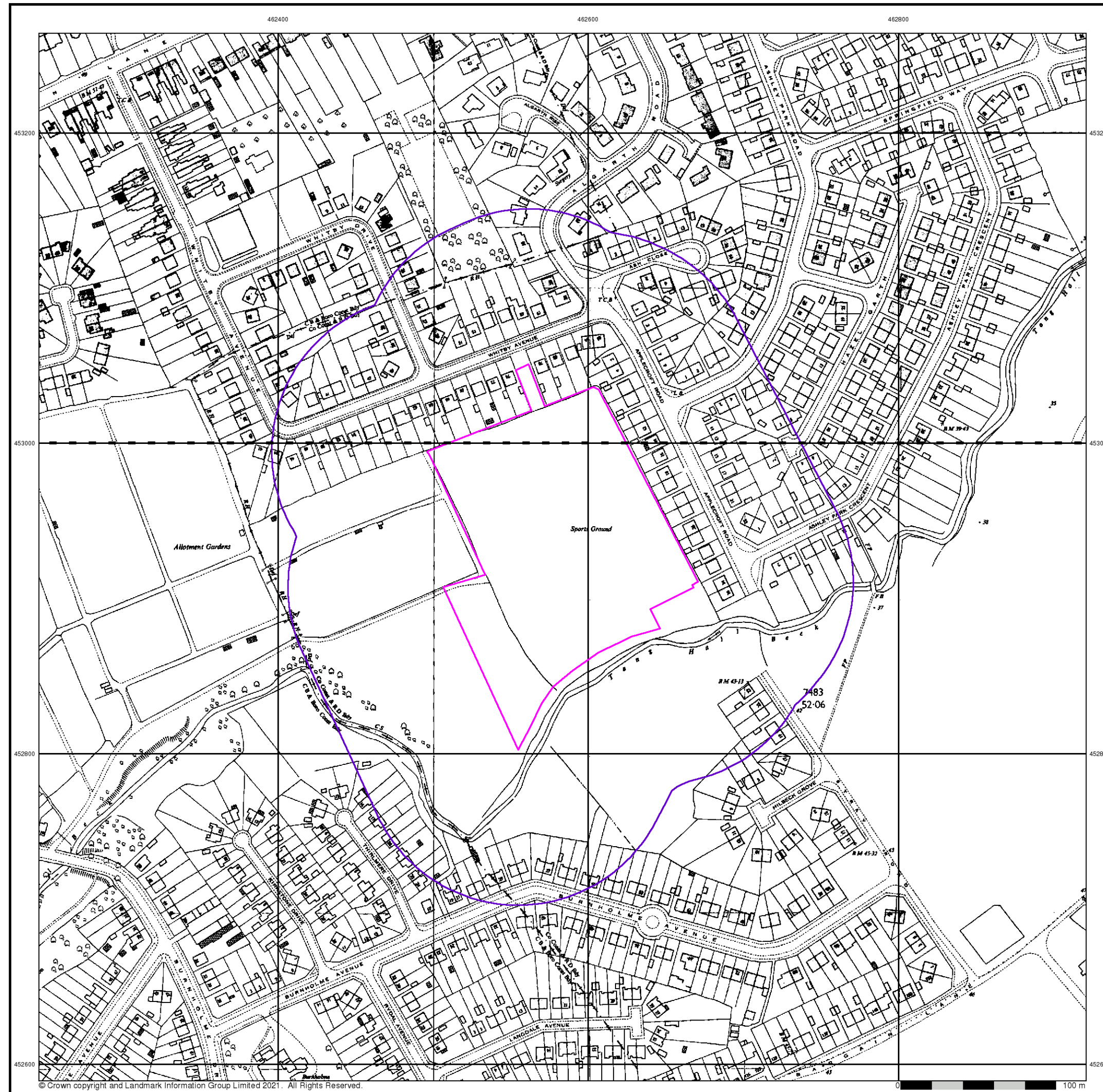

M M
MOTT MACDONALD
Ordnance Survey Plan
Published 1967
Source map scale - 1:2,500

The historical maps shown were reproduced from maps predominantly held at the scale adopted for England, Wales and Scotland in the 1840's. In 1854 the 1:2,500 scale was adopted for mapping urban areas and by 1896 it covered the whole of what were considered to be the cultivated parts of Great Britain. The published date given below is often some years later than the surveyed date. Before 1938, all OS maps were based on the Cassini Projection, with independent surveys of a single county or group of counties, giving rise to significant inaccuracies in outlying areas.

Map Name(s) and Date(s)

SE6253
1967
1:2,500
SE6252
1967
1:2,500

Historical Map - Segment A13

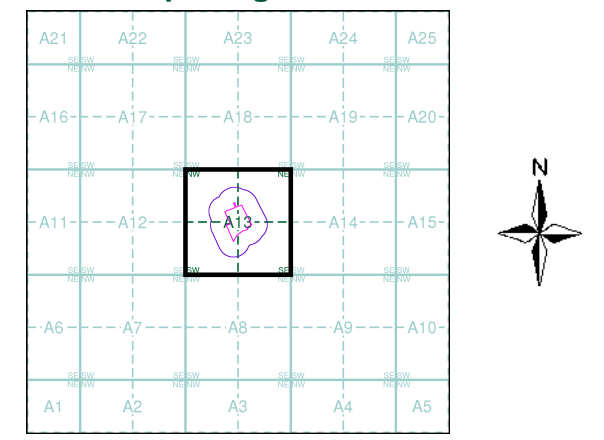

Order Details
Order Number: 285631777_1_1
Customer Ref: 100418273 (note: to transfer to Hempland)
National Grid Reference: 462570, 452930
Slice: A
Site Area (Ha): 2.22
Search Buffer (m): 100

Site Details
Hempland Primary ACADemy, Whitby Avenue, YORK, YO31 1ET

Landmark
INFORMATION GROUP
Tel: 0844 844 9952
Fax: 0844 844 9951
Web: www.envirocheck.co.uk

© Crown copyright and Landmark Information Group Limited 2021. All Rights Reserved.

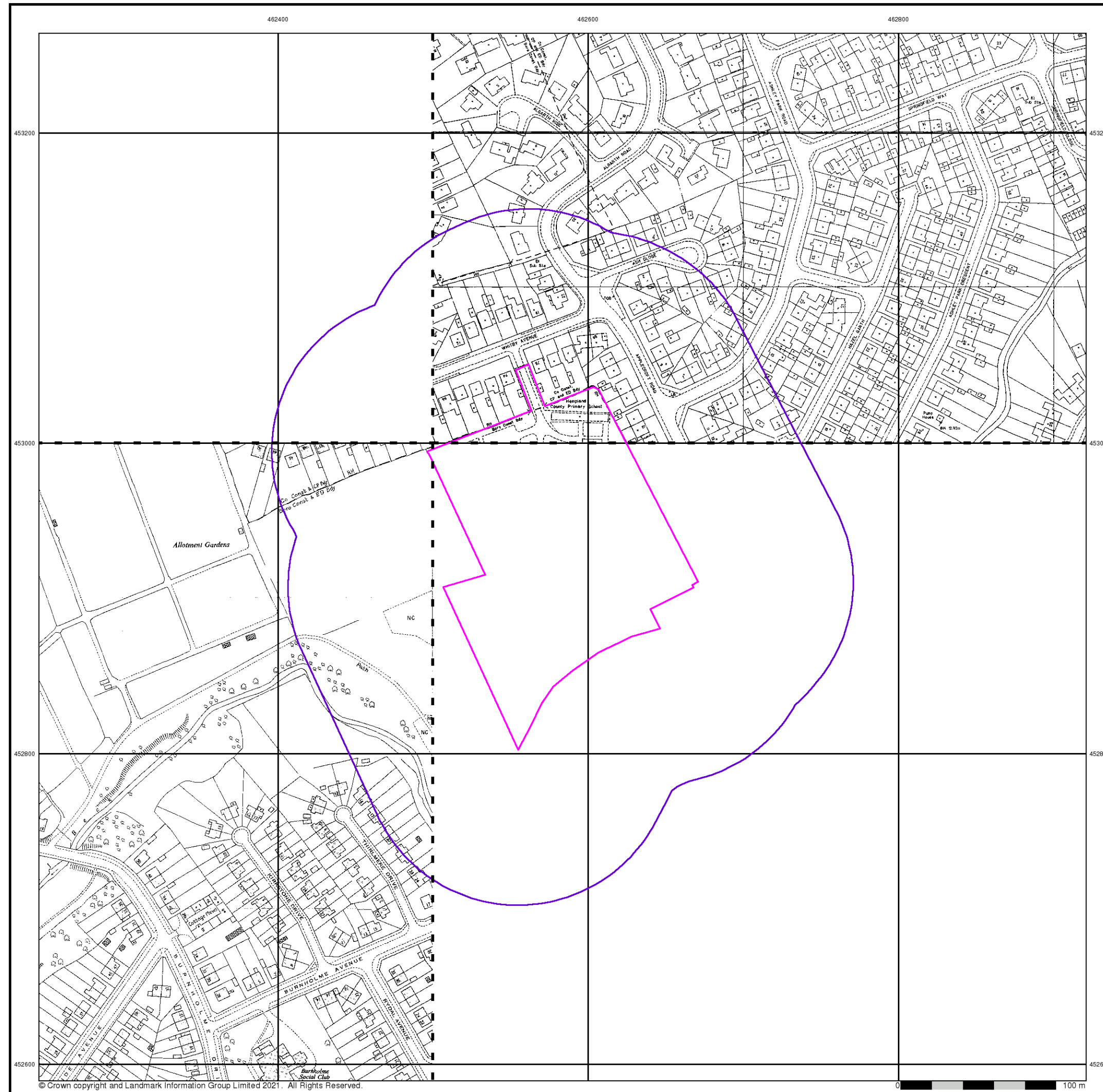

M M
MOTT
MACDONALD

Additional SIMs
Published 1988 - 1992
Source map scale - 1:1,250

The SIM cards (Ordnance Survey's 'Survey of Information on Microfilm') are further, minor editions of mapping which were produced and published in between the main editions as an area was updated. They date from 1947 to 1994, and contain detailed information on buildings, roads and land-use. These maps were produced at both 1:2,500 and 1:1,250 scales.

Map Name(s) and Date(s)

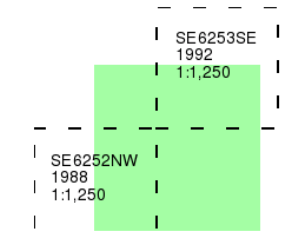

Historical Map - Segment A13

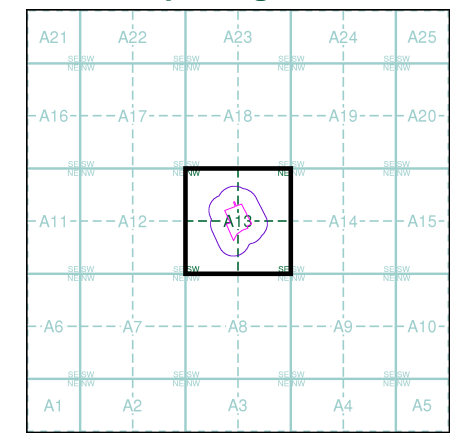

Order Details

Order Number: 285631777_1_1
 Customer Ref: 100418273 (note: to transfer to Hempland)
 National Grid Reference: 462570, 452930
 Slice: A
 Site Area (Ha): 2.22
 Search Buffer (m): 100

Site Details

Hempland Primary ACADemy, Whiby Avenue, YORK, YO31 1ET

Landmark
 INFORMATION GROUP

Tel: 0844 844 9952
 Fax: 0844 844 9951
 Web: www.envirocheck.co.uk

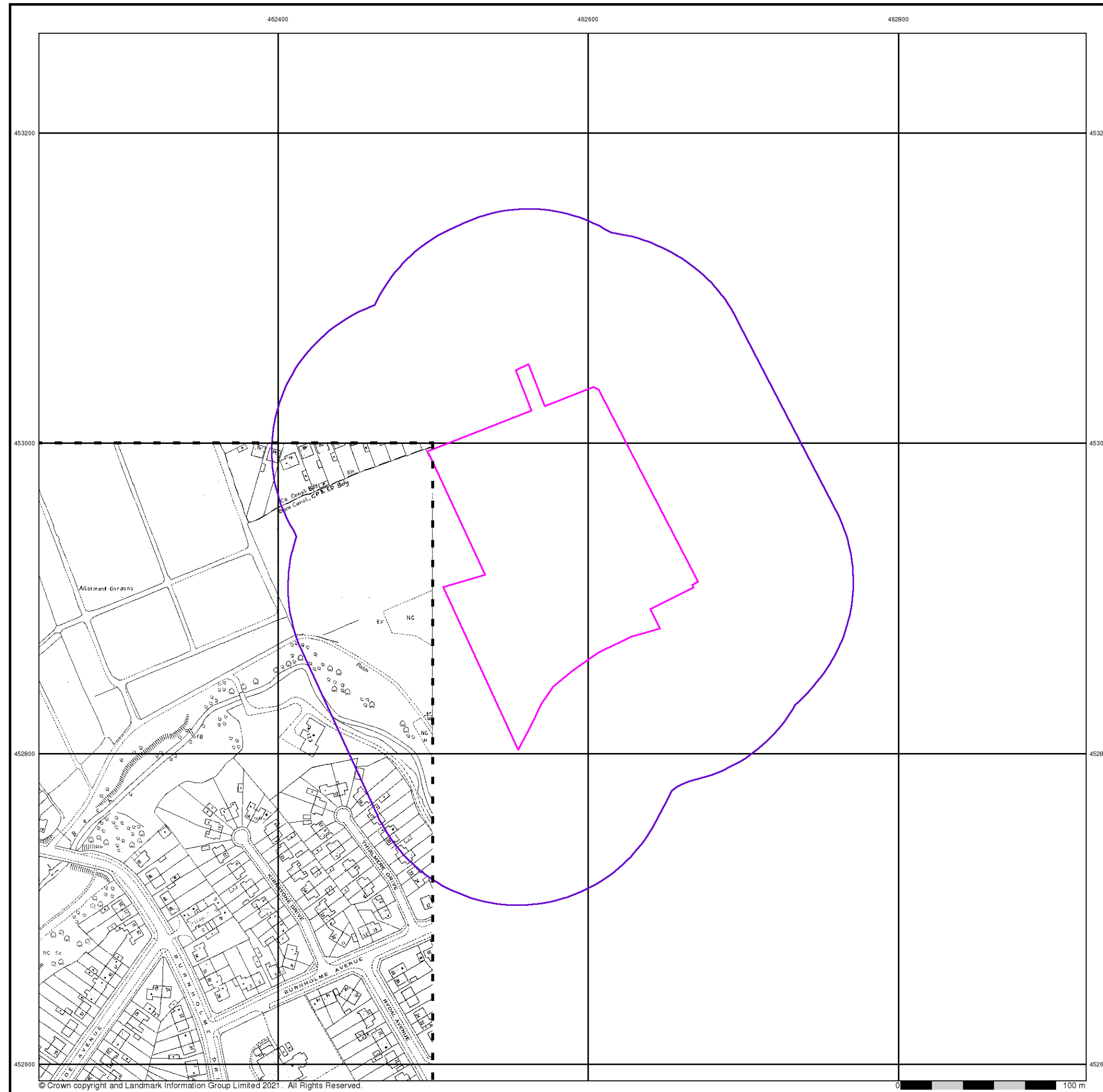

M M
MOTT
MACDONALD
Additional SIMs
Published 1991
Source map scale - 1:1,250

The SIM cards (Ordnance Survey's 'Survey of Information on Microfilm') are further, minor editions of mapping which were produced and published in between the main editions as an area was updated. They date from 1947 to 1994, and contain detailed information on buildings, roads and land-use. These maps were produced at both 1:2,500 and 1:1,250 scales.

Map Name(s) and Date(s)

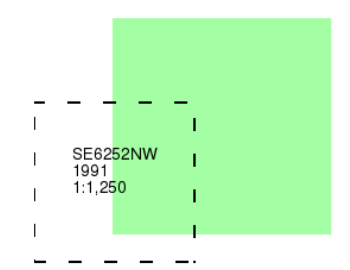

Historical Map - Segment A13

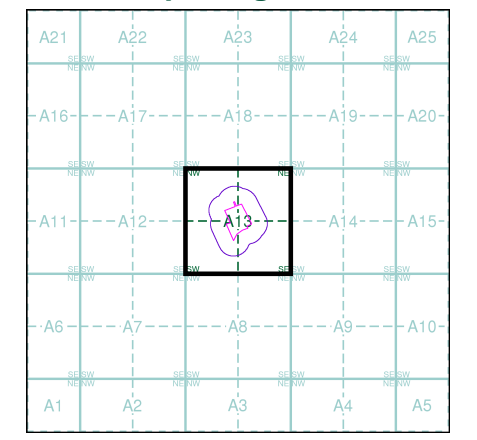

Order Details

Order Number: 285631777_1_1
 Customer Ref: 100418273 (note: to transfer to Hempland)
 National Grid Reference: 462570, 452930
 Slice: A
 Site Area (Ha): 2.22
 Search Buffer (m): 100

Site Details

Hempland Primary ACADemy, Whitby Avenue, YORK, YO31 1ET

Landmark
 INFORMATION GROUP
 Tel: 0844 844 9952
 Fax: 0844 844 9951
 Web: www.envirocheck.co.uk

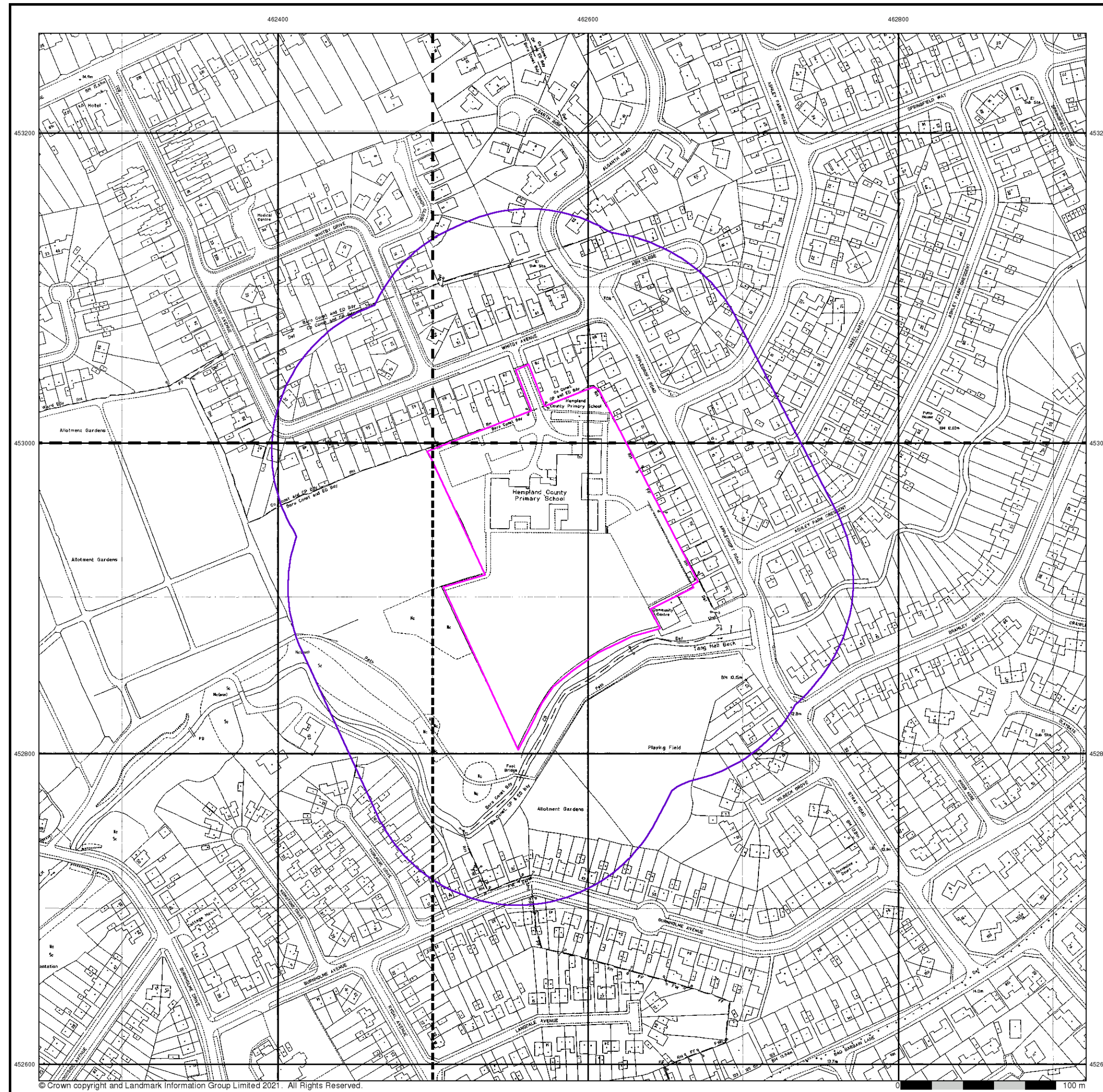

M M
MOTT MACDONALD
Large-Scale National Grid Data
Published 1993
Source map scale - 1:1,250

'Large Scale National Grid Data' superseded SIM cards (Ordnance Survey's 'Survey of Information on Microfilm') in 1992, and continued to be produced until 1999. These maps were the fore-runners of digital mapping and so provide detailed information on houses and roads, but tend to show less topographic features such as vegetation. These maps were produced at both 1:2,500 and 1:1,250 scales.

Map Name(s) and Date(s)

SE 6253SW 1993 1:1,250	SE 6253SE 1993 1:1,250
SE 6252NW 1993 1:1,250	SE 6252NE 1993 1:1,250

Historical Map - Segment A13

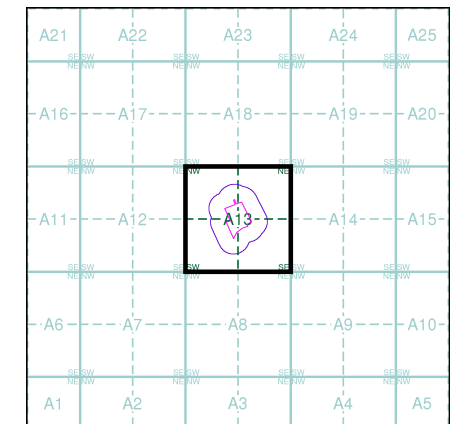

Order Details

Order Number: 285631777_1_1
 Customer Ref: 100418273 (note: to transfer to Hempland)
 National Grid Reference: 462570, 452930
 Slice: A
 Site Area (Ha): 2.22
 Search Buffer (m): 100

Site Details

Hempland Primary ACADemy, Whitby Avenue, YORK, YO31 1ET



Tel: 0844 844 9952
 Fax: 0844 844 9951
 Web: www.envirocheck.co.uk