



The Residence Collection

# The Residence Collection

## What is The Residence Collection?



R7 R<sup>2</sup> R9

- The Residence Collection brings together a suite of premium window and door systems, designed and made in Great Britain.
- Three systems all look identical from the outside; all flush externally.
- R7 = Fully flush frame and mullion internally.
- R<sup>2</sup> = Square frame and flush mullion internally.
- R9 = Decorative frame and mullion internally.



# The Residence Collection

## About The Residence Collection



- The most authentic and traditional sight lines of the timber alternative window and door market.
- Fully mechanical jointed options available for all systems.
- Aesthetic of a timber/aluminium products with the durability, low maintenance and excellent thermal properties of PVCu material.
- All look identical from the outside; fully flush. Detail is on the inside on the frame and the glazing bead.
- Five glazing bead options for all systems; 3 x 28mm (double) styles in Decorative, Staff and Square plus 2 x 44mm (triple) styles in Decorative and Square.

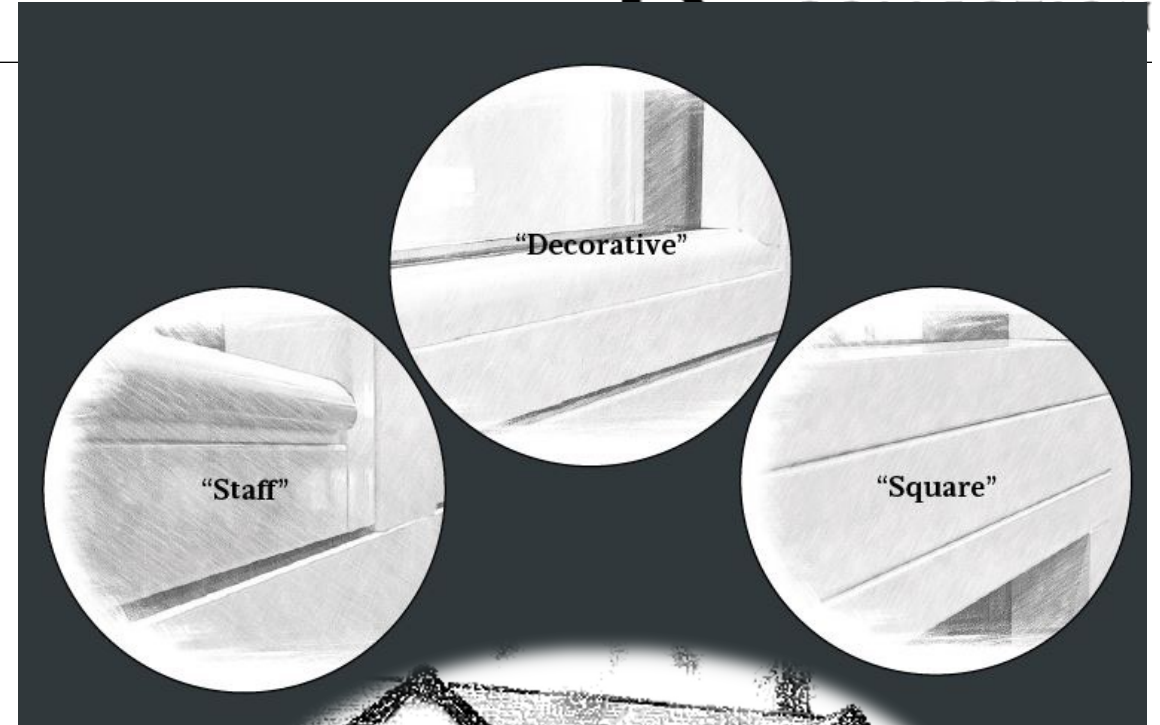

# Residence 9

## Features and Benefits



- 9 Chamber 100mm frame for optimised thermal performance with composite inserts for screw retention.
- 7 Chamber sash able to carry steel reinforcement for optimised strength and resistance to thermal expansion.
- 28mm standard and 44mm high performance glazing options.
- Various manufacturing methods from full mechanical to weld options. Glass bonding can be used to provide increased strength, maximum sizes, weather performance and security of the window or door.

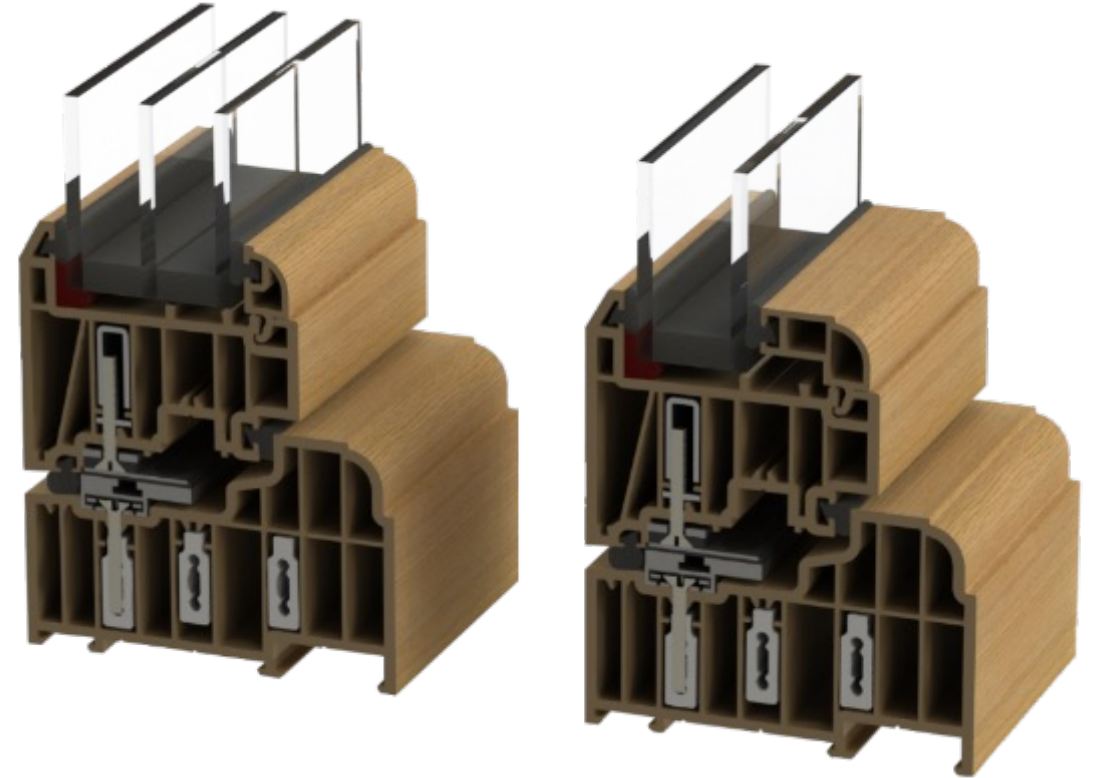

# Residence 9

Conservation Areas & Grade II Listed

- All the glass sightlines are perfectly equal providing symmetry and style.
- The internal shape and depth is completely authentic and gives an elegant and distinctively deep appearance.
- 19<sup>th</sup> century timber windows are authentically recreated in a modern, maintenance-free material.

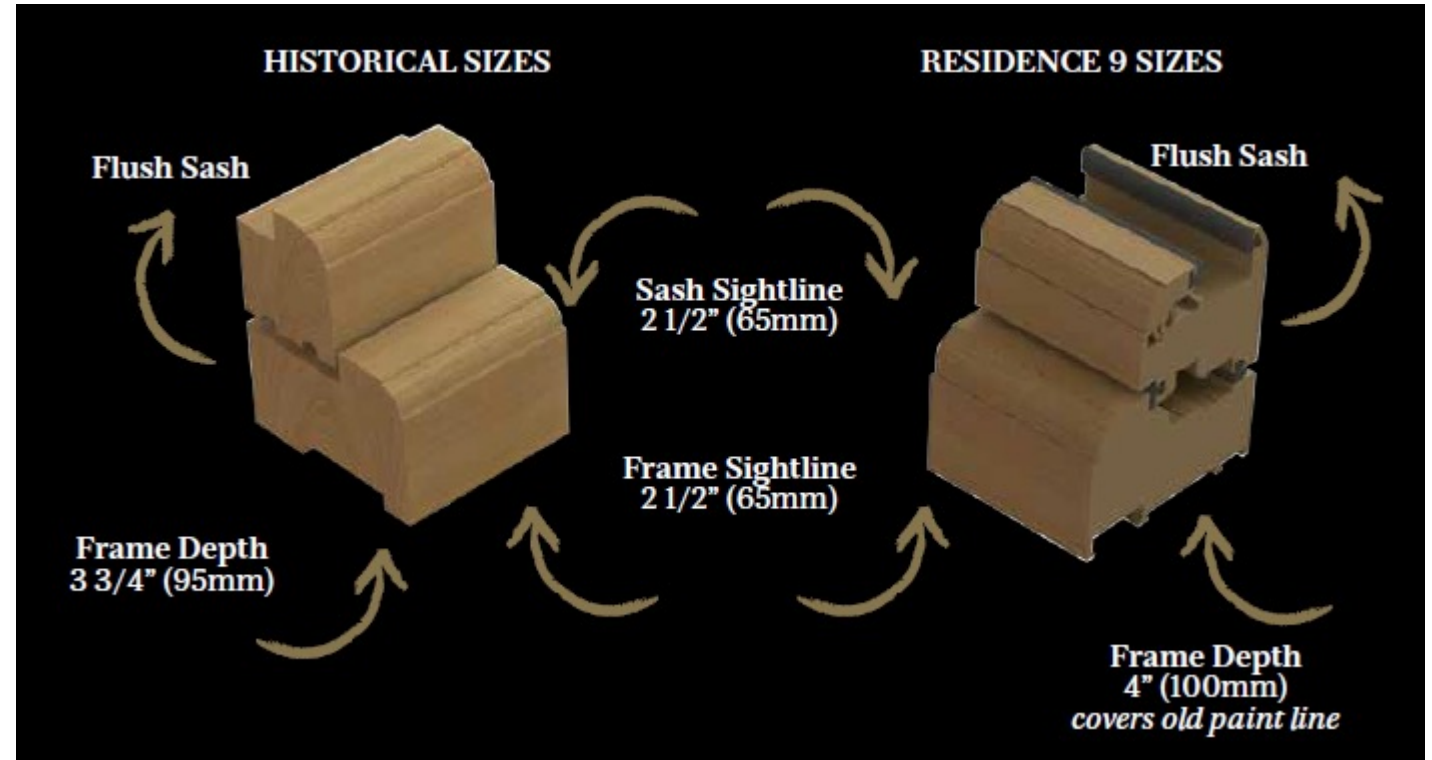

# The Residence Collection

## Conservation Areas & Grade II Listed



- A quote from NCHA (Nottingham Community Housing Association) - Property Services “We were looking to replace all the timber windows to one of our conservation properties. We needed to be compliant, but we also wanted to achieve cost savings (access, repairs and cyclical painting) and Residence 7 fitted our requirements completely. The timber welded joints with internal beads aid quick changes of any broken units, and easy clean hinges allow our tenants to clean their own windows. The windows have been designed for timber replacement and aesthetically they look the part.”



# The Residence Collection

## Conservation Areas & Grade II Listed



Over 150 Conservation installations in over 70 different areas



9 Listed Building installations in 8 different areas



# Residence 9 and Residence<sup>2</sup> Coupling Options

10mm In-Line



24mm In-Line

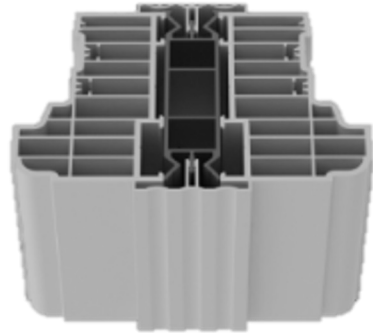

40mm In-Line

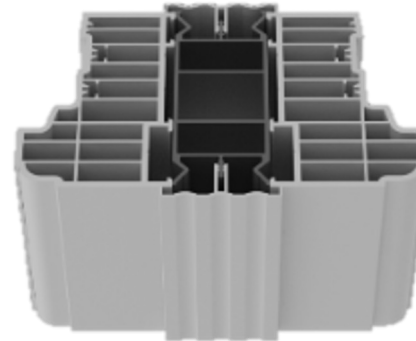

132mm In-Line

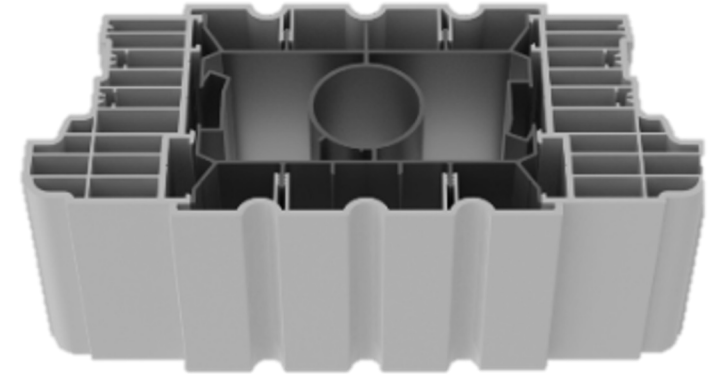

90°

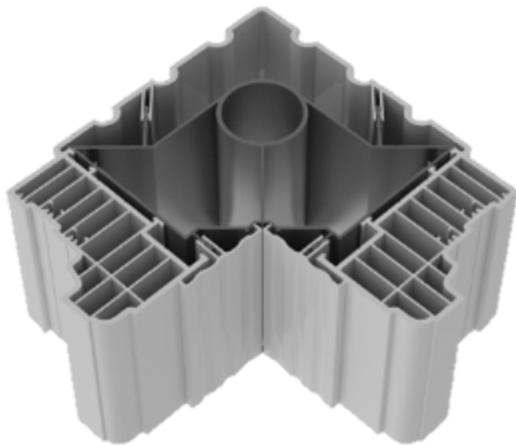

120° - 165° Variable

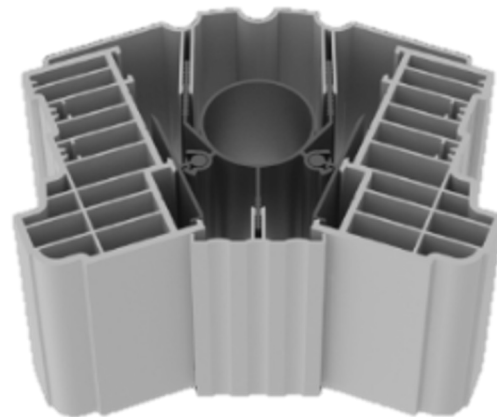

24mm In-Line

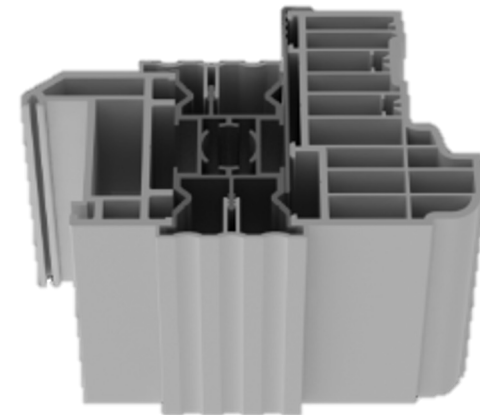



# Residence<sup>2</sup>

## Features and Benefits

---

- 9 Chamber 100mm frame for optimised thermal performance with composite inserts for screw retention.
- 7 Chamber sash able to carry steel reinforcement for optimised strength and resistance to thermal expansion.
- 28mm standard and 44mm high performance glazing options.
- Option for mechanical joint or mitred weld dependant upon the desired aesthetic.

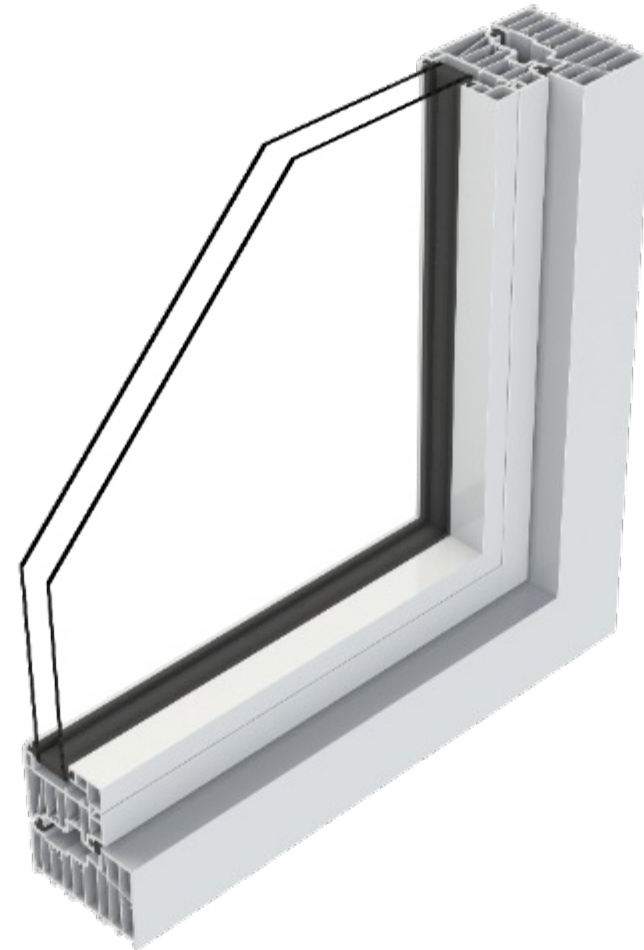

# Residence 7

## Features and Benefits

- 7 Chamber 75mm frame for optimised thermal performance with composite inserts for screw retention and the option for steel reinforcements if required.
- 7 Chamber sash able to carry steel reinforcement for optimised strength and resistance to thermal expansion. (same sash is used for all three systems).
- 28mm double and 44mm triple high performance glazing options.
- Using the square glazing bead an aluminium aesthetic can be achieved.

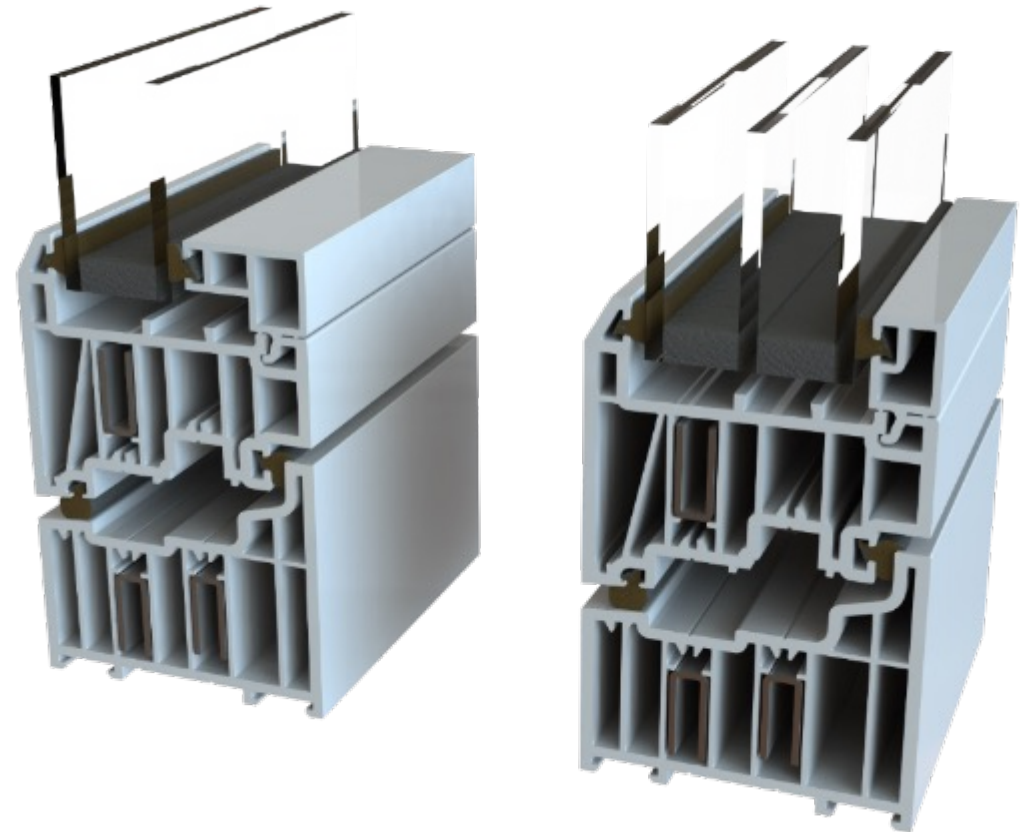

# Residence 7

## Coupling Options

10mm In-Line

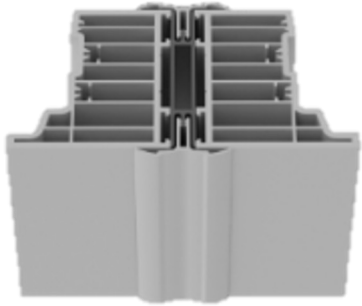

24mm In-Line

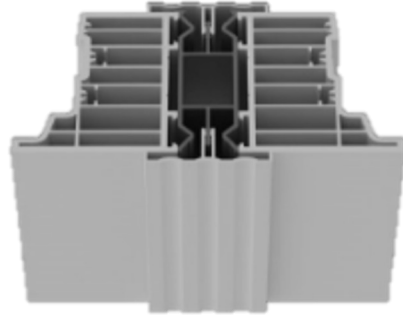

40mm In-Line

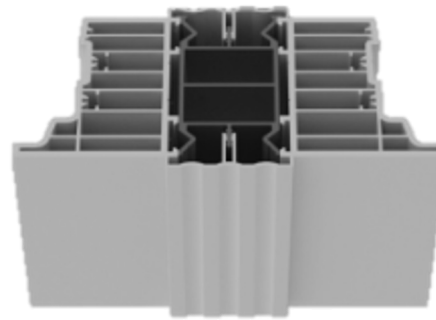

132mm In-Line

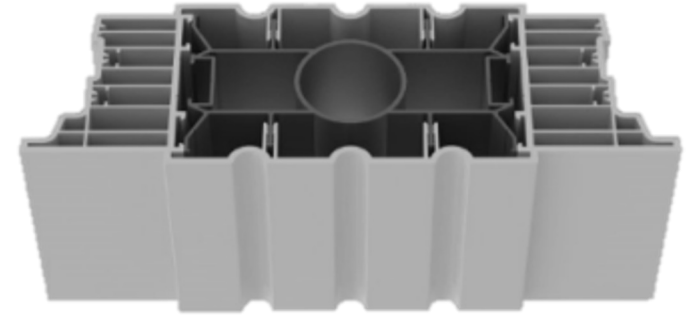

90°



90°

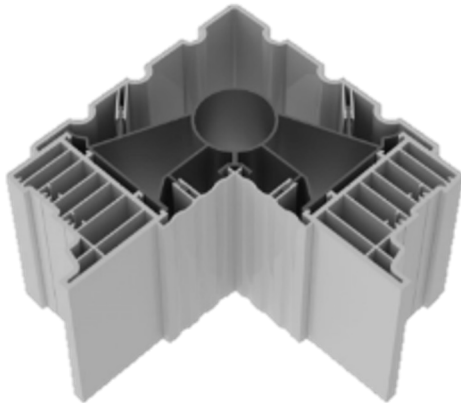

94°– 125° Variable



120°– 165° Variable

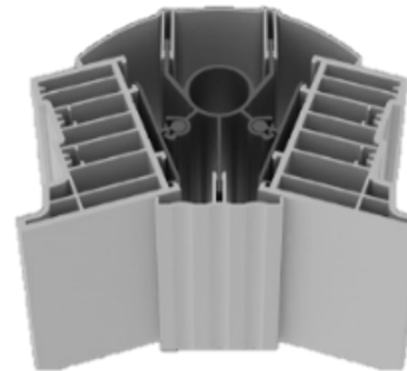

160°– 180° Variable



# Residence 9

## Colour options



- Always foiled.
- Dual foils available as standard.
- Fully foiled 360° mullion and foiled through the rebate chamber of the frame, therefore no 'plastic' on show.
- Easy clean rebate (patented), no sharp edges or gaskets on the frame.
- Composite look aluminium clad timber windows can be achieved with English Oak inside and Eclectic Grey outside plus a range of fashionable grey, green and cream shades and traditional oak finishes.

		INSIDE COLOUR								
		Grained White	Cotswold Biscuit	Clotted Cream	Cotswold Green	Painswick	English Oak	Irish Oak	Silvered Oak	Eclectic Grey
RESIDENCE 9® OUTSIDE COLOUR	Grained White	Grained White								
	Cotswold Biscuit	Cotswold Biscuit	Cotswold Biscuit							
	Clotted Cream	Clotted Cream		Clotted Cream						
	Cotswold Green	Cotswold Green			Cotswold Green					
	Painswick	Painswick		Painswick		Painswick				
	English Oak	English Oak					English Oak			
	Irish Oak	Irish Oak						Irish Oak		
	Silvered Oak	Silvered Oak							Silvered Oak	
	Eclectic Grey	Eclectic Grey						Eclectic Grey		Eclectic Grey
	No. 10 Black	No. 10 Black	No. 10 Black					No. 10 Black		
	Corse Lawn	Corse Lawn								

This shows the colour options available for R9 windows and open-out doors only.

# Residence 7

## Colour options

- Solid colour options available (White, Cream and Grey).
- Foiled 'on white' available which gives a contemporary fuss-free finish to the inside.
- Easy clean rebate (patented), no sharp edges or gaskets on the frame.
- Foiled both sides will come with a 'like colour' extrusion, for example Eclectic Grey both sides will be on a dark grey substrate.

	INSIDE COLOUR									
	Grained White	Clotted Cream	English Oak	Irish Oak	Golden Oak	Rosewood	Eclectic Grey	Vintage Cream (unfoiled)	Chalk White (unfoiled)	No.38 Grey (unfoiled)
Grained White	Grained White									
Clotted Cream		Clotted Cream							Chalk White (unfoiled)	
Cotswold Green									Cotswold Green	
Painswick									Painswick	
English Oak			English Oak						English Oak	
Irish Oak				Irish Oak					Irish Oak	
Golden Oak					Golden Oak				Golden Oak	
Rosewood						Rosewood			Rosewood	
Eclectic Grey							Eclectic Grey		Eclectic Grey	
No. 10 Black									No. 10 Black	
Corse Lawn									Corse Lawn	
Vintage Cream (unfoiled)								Vintage Cream (unfoiled)		
Chalk White (unfoiled)									Chalk White (unfoiled)	
No. 38 Grey (unfoiled)										No. 38 Grey (unfoiled)

**RESIDENCE 7**  
OUTSIDE COLOUR

This shows the colour options available for R7 windows and open-out doors only.

# Residence<sup>2</sup> Colour options



- Solid colour options available (White, Cream and Grey).
- Easy clean rebate (patented), no sharp edges or gaskets on the frame.
- Foiled both sides will come with a 'like colour' extrusion, for example Eclectic Grey both sides will be on a dark grey substrate.

RESIDENCE <sup>2</sup> OUTSIDE COLOUR	INSIDE COLOUR									
	Grained White	Clotted Cream	Painswick	English Oak	Irish Oak	Silvered Oak	Eclectic Grey	Vintage Cream (unfoiled)	Chalk White (unfoiled)	No.38 Grey (unfoiled)
Grained White	Grained White									
Clotted Cream		Clotted Cream								
Painswick			Painswick							
English Oak				English Oak						
Irish Oak					Irish Oak					
Silvered Oak						Silvered Oak				
Eclectic Grey							Eclectic Grey		Chalk White (unfoiled)	
Vintage Cream (unfoiled)								Vintage Cream (unfoiled)		
Chalk White (unfoiled)									Chalk White (unfoiled)	
No. 38 Grey (unfoiled)										No. 38 Grey (unfoiled)

This shows the colour options available for R<sup>2</sup> windows and open-out doors only.

# The Residence Collection

## Cills

- Range of cills 95mm, 165mm and 180mm.
- If replacing an old timber cill 'The Radlington' is the modern interpretation of a timber cill with a deep nose.



# The Residence Collection

## Hardware



- Inspired by the appearance of 19th Century ironmongery.
- Available in a range of nine exclusive finishes.
- Security benefit of being key locking.
- Matching stays available, these can be working and dummy.
- Black or Painted White butt hinges, these can traditionally working or dummy for use with modern friction stay hinges. Working butt hinges can also be utilised for fire escape windows.





# The Residence Collection

## WERS & U-Values



System	Description	Glazing Width	Glazing Description	Spacer Bar	WER/U-Value
Residence 9	Unreinforced	44mm	4/16/4/16/4 Diamant/Total +/Total + (90% Argon)	Swisspacer U	A++/0.8W/m <sup>2</sup> K
Residence 9	Unreinforced	44mm	4/16/4/16/4 Planiclear/Planitherm One II/Planitherm One II (90% Argon)	Thermobar	B/0.74W/m <sup>2</sup> K
Residence 9	Fully Reinforced	28mm	4/20/4 Planiclear/Argon90%/Total+	Swisspacer U	A/1.2W/m <sup>2</sup> K
Residence 9	Unreinforced	28mm	4/20/4 Planiclear/Argon90%/Total+	Swisspacer V	B/1.22W/m <sup>2</sup> K
Residence 7	Unreinforced	44m	4/16/4/16/4 Diamant/Total +/Total + (90% Argon)	Swisspacer U	A++/0.84W/m <sup>2</sup> K
Residence 7	Unreinforced	28mm	4/20/4 Diamant/Argon90%/Total+	Swisspacer U	A/1.23W/m <sup>2</sup> K
Residence 7	Unreinforced	28mm	4/20/4 Planiclear/Argon90%/Total+	Swisspacer U	A/1.23W/m <sup>2</sup> K

# The Residence Collection

## Product Testing



Exova Warrington  
One Industrial Park  
Falcon Road  
Warrington  
WA10 5DA

T: +44 (0) 1825 722 122  
F: +44 (0) 1825 421 242  
E: sales@exova.com  
W: www.exova.com



Exova Warrington  
One Industrial Park  
Falcon Road  
Warrington  
WA10 5DA

T: +44 (0) 1825 722 122  
F: +44 (0) 1825 421 242  
E: sales@exova.com  
W: www.exova.com



Exova Warrington  
One Industrial Park  
Falcon Road  
Warrington  
WA10 5DA

T: +44 (0) 1825 722 122  
F: +44 (0) 1825 421 242  
E: sales@exova.com  
W: www.exova.com



### BS 6375-1:2009

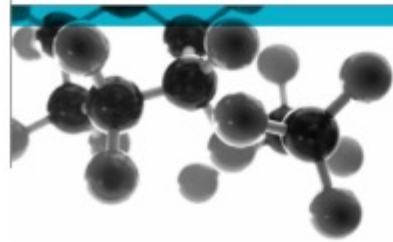

Test of: Residence 9 (R9) Dual Casement Window  
Performance of windows & doors  
Part 1: Weathertightness

A Report To: Ecolabio Systems LLP  
Document Reference: WIL 330565

Date: 19/05/2014  
Copy: 1  
Issue No.: 1  
Page 1

Testing  
Advising  
Assuring



Registered Office: Stone Court, Levens Industrial Estate, Levensage, Mollison D12 8PL, United Kingdom. Reg No. 02120  
This report is issued in accordance with our terms and conditions, a copy of which is available on request.

### BS 6375-2:2009

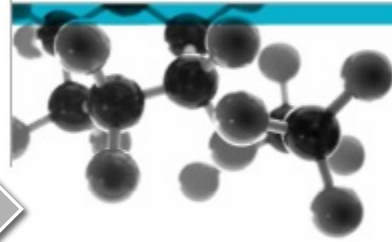

Test of: Residence 9 (R9) Dual Side Hung Window  
Performance of windows & doors  
Part 2: Operation & strength

A Report To: Ecolabio Systems LLP  
Document Reference: WIL 243083

Date: 22/07/2014  
Copy: 01  
Issue No.: 01  
Page 1

Testing  
Advising  
Assuring



Registered Office: Stone Court, Levens Industrial Estate, Levensage, Mollison D12 8PL, United Kingdom. Reg No. 02120  
This report is issued in accordance with our terms and conditions, a copy of which is available on request.

### PAS 24:2012



Test of: Residence 9 (R9) Dual Casement Window  
Enhanced security performance requirements for  
windows in the UK

A Report To: Ecolabio Systems LLP  
Document Reference: WIL 330566

Date: 20/05/2014  
Copy: 1  
Issue No.: 1  
Page 1

Testing  
Advising  
Assuring



Registered Office: Stone Court, Levens Industrial Estate, Levensage, Mollison D12 8PL, United Kingdom. Reg No. 02120  
This report is issued in accordance with our terms and conditions, a copy of which is available on request.

# The Residence Collection

## Product Testing – PAS24



System	BSEN6375-1	BSEN6375-2	PAS 24	Style	Size
Residence 9	✓	✓	✓	Double Window	1800 x 1650
Residence 9	✓	✓	✓	Single Door (Outward opening)	900 x 2100
Residence 9	✓	✓	✓	French Door (Outward opening)	1500 x 2100
Residence 7	✓	✓	✓	Double Window	1800 x 1650
Residence <sup>2</sup>	✓	✓	✓	French Door (Outward opening)	2005 x 2400



# The Residence Collection

## Product Re-cap



# R7

- 75mm system
- Flush both sides
- 7 chamber frame
- 28mm & 44mm glazing
- 5 bead options



# The Residence Collection

## Product Re-cap



# R<sup>2</sup>

- 100mm system
- Flush outside & Square inside
- 9 chamber frame
- 28mm & 44mm glazing
- 5 bead options



# The Residence Collection

## Product Re-cap



# R9

- 100mm system
- Flush outside & Decorative inside
- 9 chamber frame
- 28mm & 44mm glazing
- 5 bead options



Thank you!

Please visit [www.residencecollection.co.uk](http://www.residencecollection.co.uk) for further information