

1 Substation Illustration
1:50

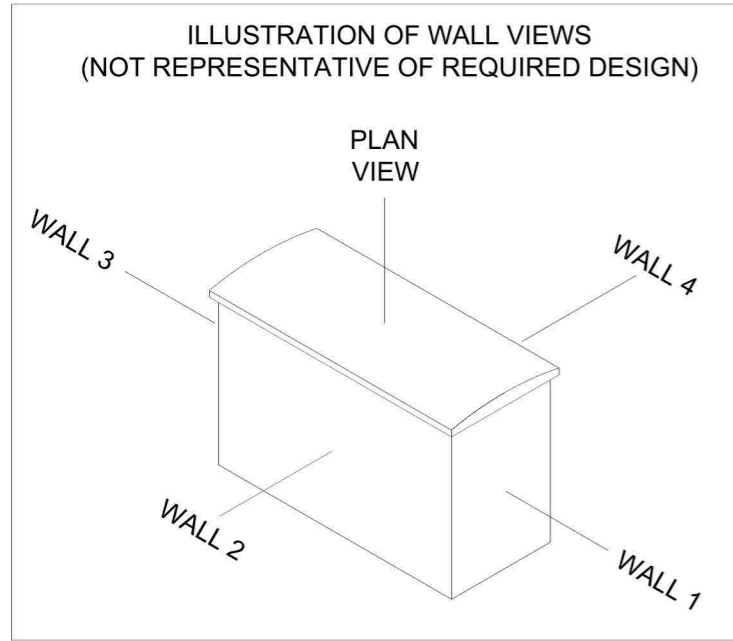

2 Substation Plan
1:50

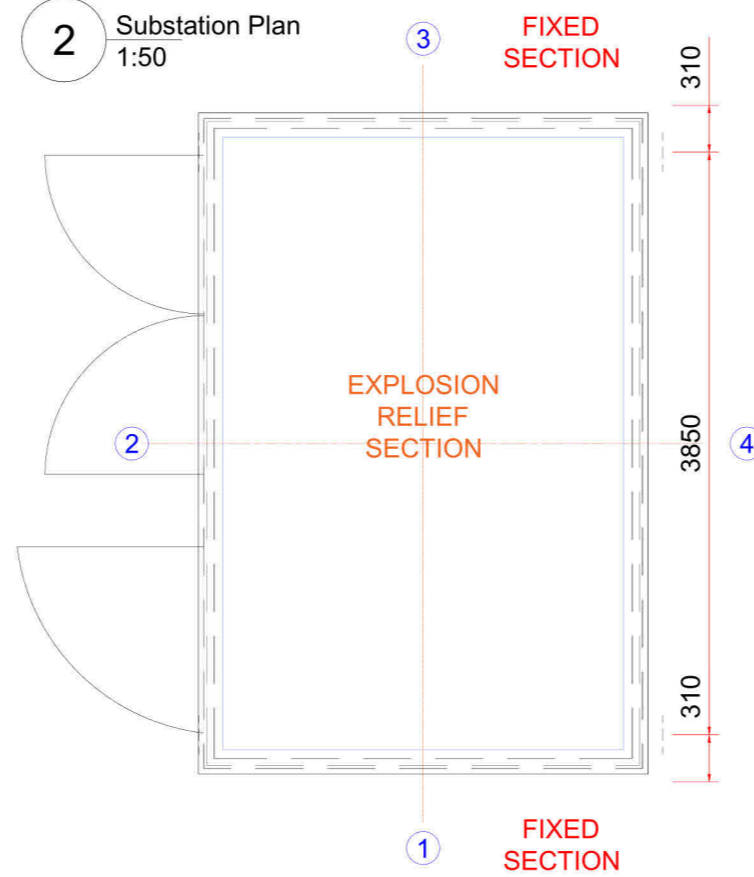

7 3D View
NTS

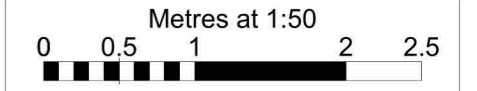
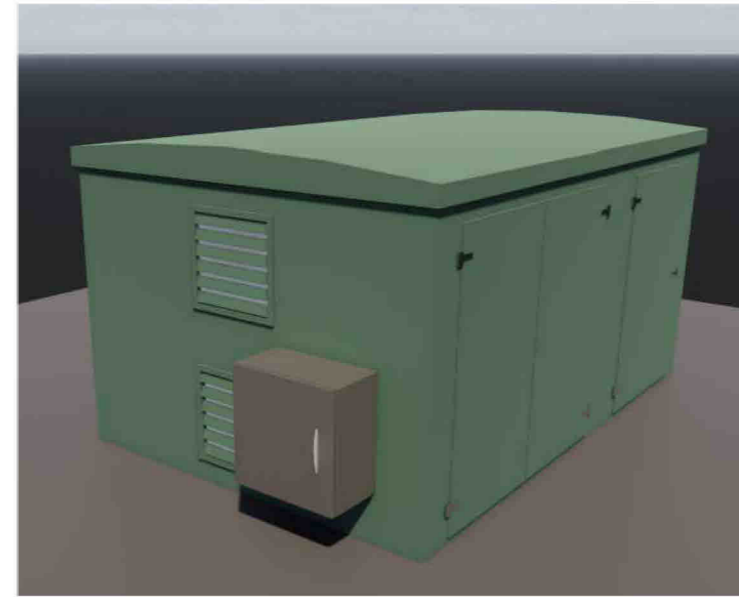

- Notes
- GRP Substation colour options:
 - RAL 00 A 05 - Goose Grey
 - RAL 14 C 39 - Holly Green

3 Front Elevation
1:50

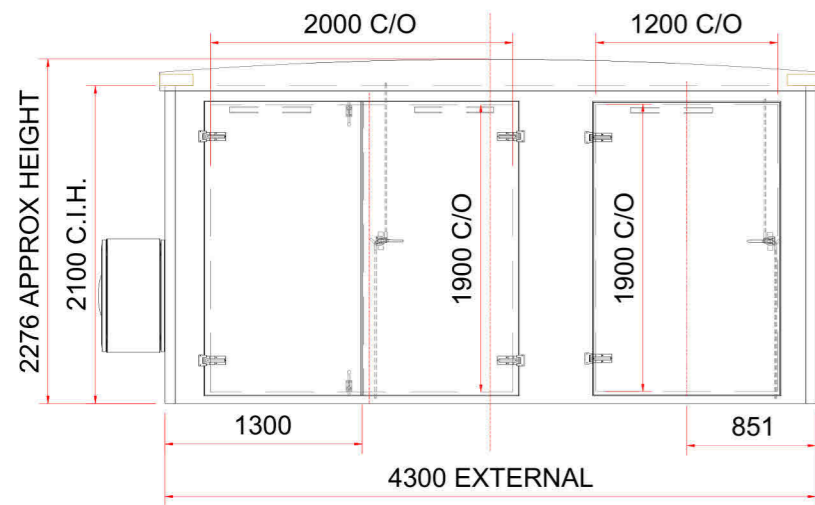

4 Right Elevation
1:50

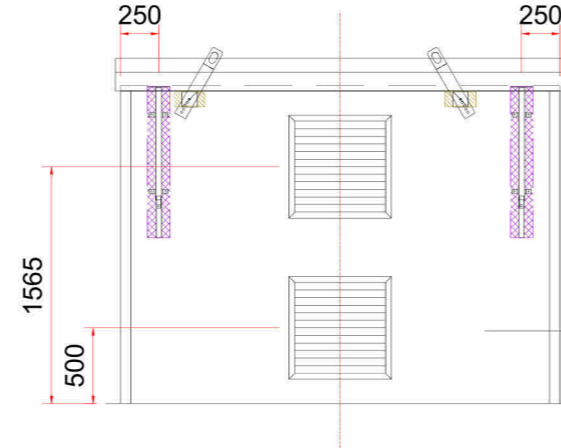

5 Rear Elevation
1:50

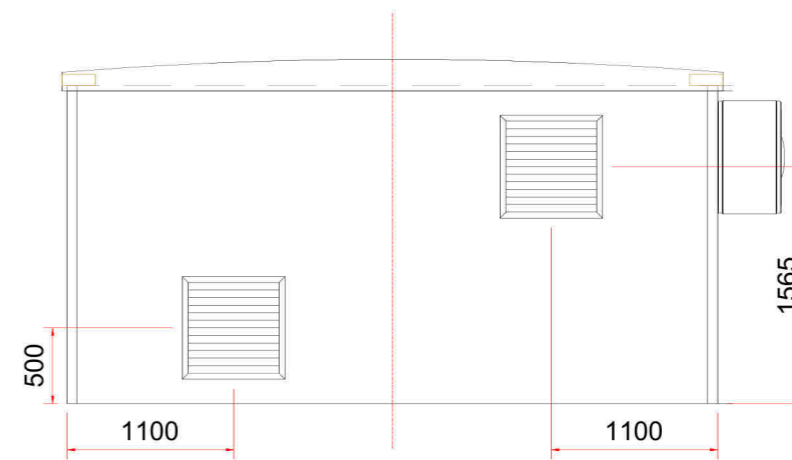

6 Left Elevation
1:50
1592 (LIFTING EYE CENTRES)

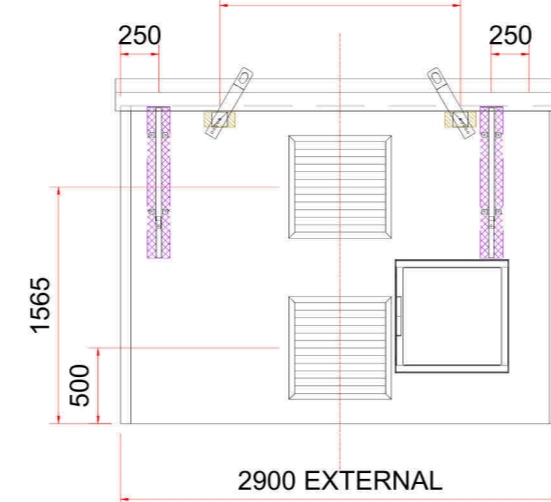

FOR CONSTRUCTION

02 14/03/23	Meter enclosure shown	DO	SC	DM	CB
01 14/12/22	First Issue	SC	DO	DM	CB
Rev Date	Description	DRN	CHK	REV	APR



Project
Standard Details

Drawing Title
Substation Details

Scale & Papersize
As Indicated @ A3

Suitability Code	Project Status
D4 - For Manufacture/Procurement	Published documentation

Drawing Number	Revision
XXXX-SSE-XX-XX-DR-E-1603	02