

SOUTH EAST

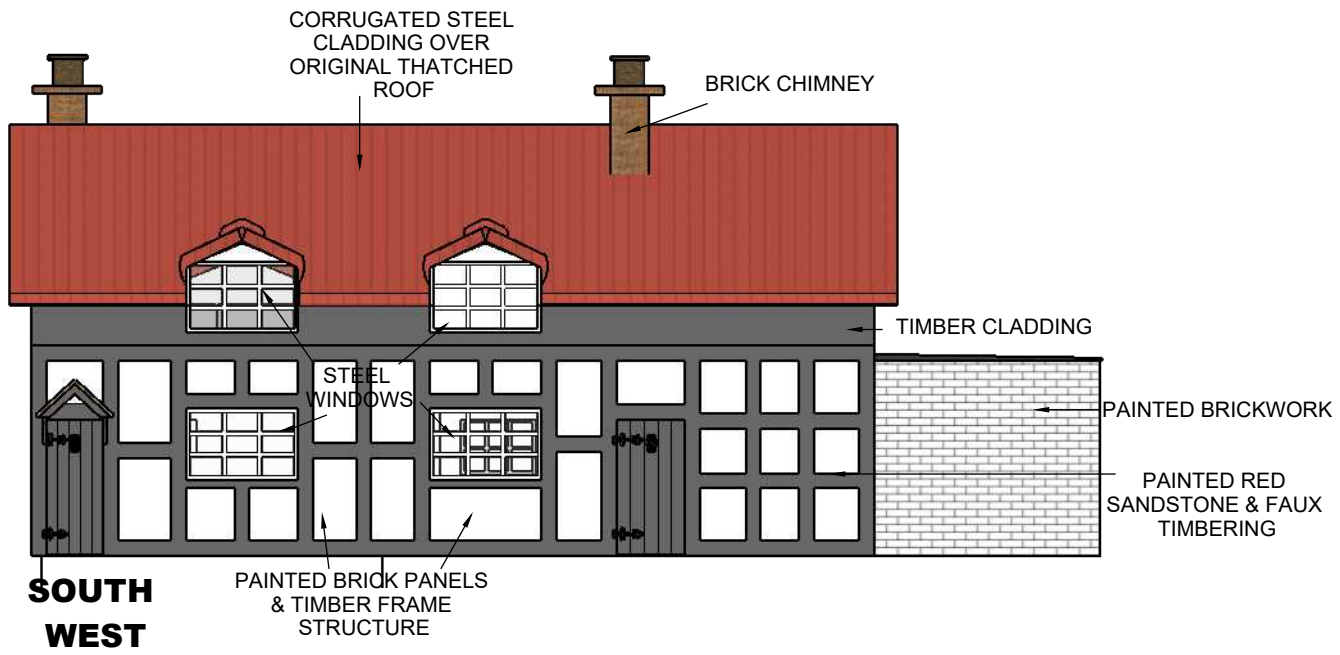

SOUTH WEST

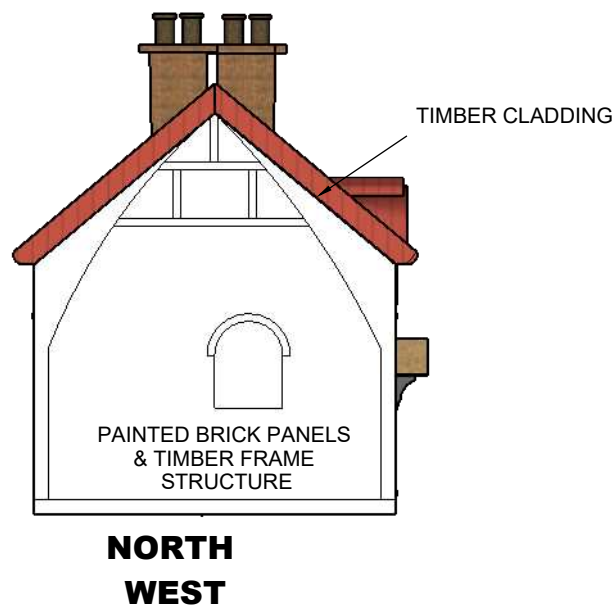

NORTH WEST

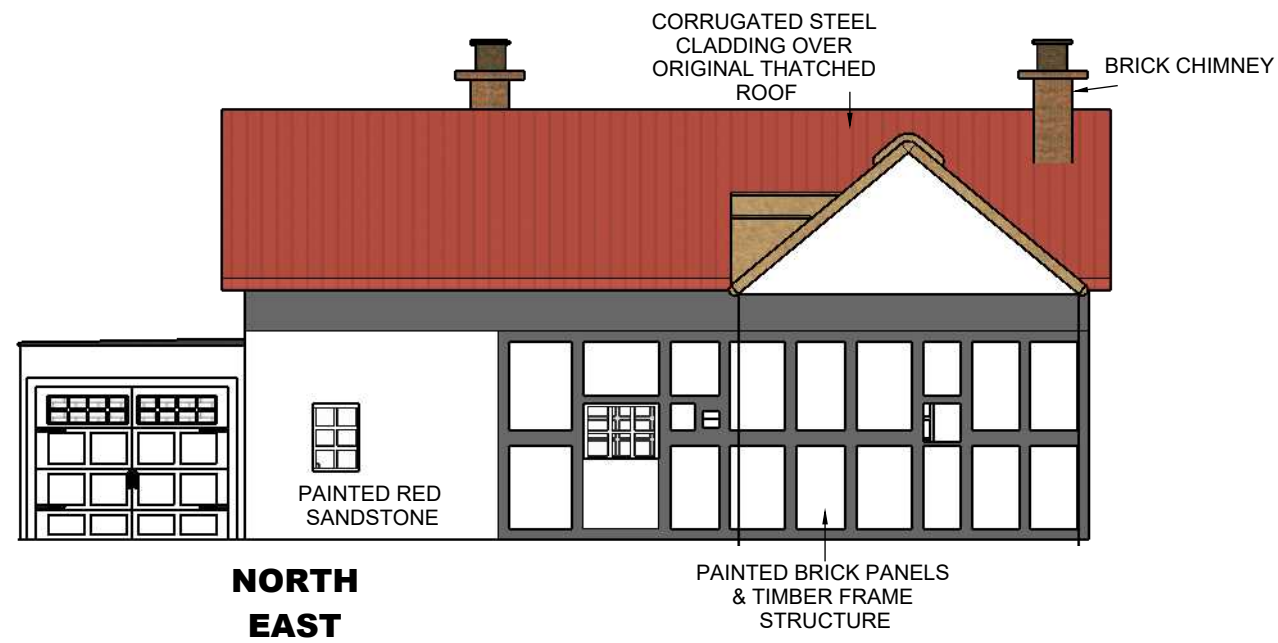

NORTH EAST

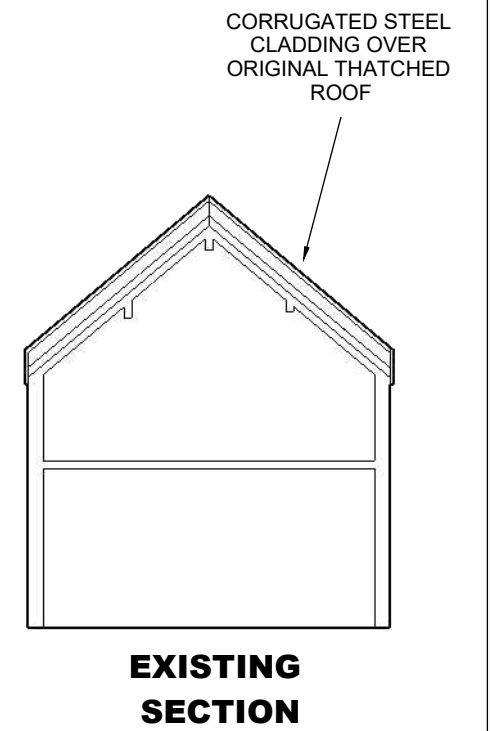

EXISTING SECTION

PROJECT
HAWTHORN COTTAGE, BURWARDSLEY ROAD,
TATTENHALL, CH3 9NS

CLIENT
L HAINES

TITLE
EXISTING ELEVATIONS & SECTION

DATE
AUGUST 22

SCALE
1:100 @A3

1:100  metres

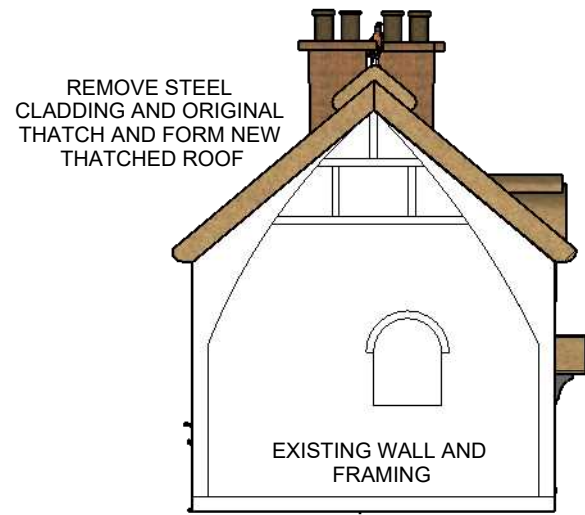

NORTH WEST



SOUTH WEST

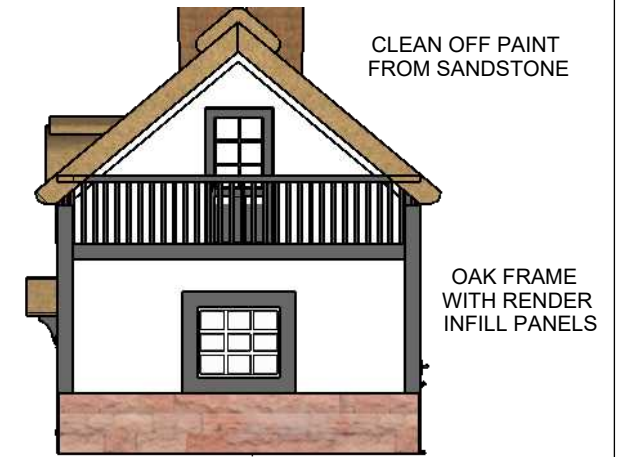

SOUTH EAST



NORTH EAST

PROJECT
HAWTHORN COTTAGE, BURWARDSLEY ROAD,
TATTENHALL, CH3 9NS

CLIENT
L HAINES

TITLE
PROPOSED ELEVATIONS

DATE
AUGUST 22

SCALE
1:100 @A3

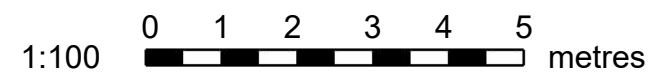

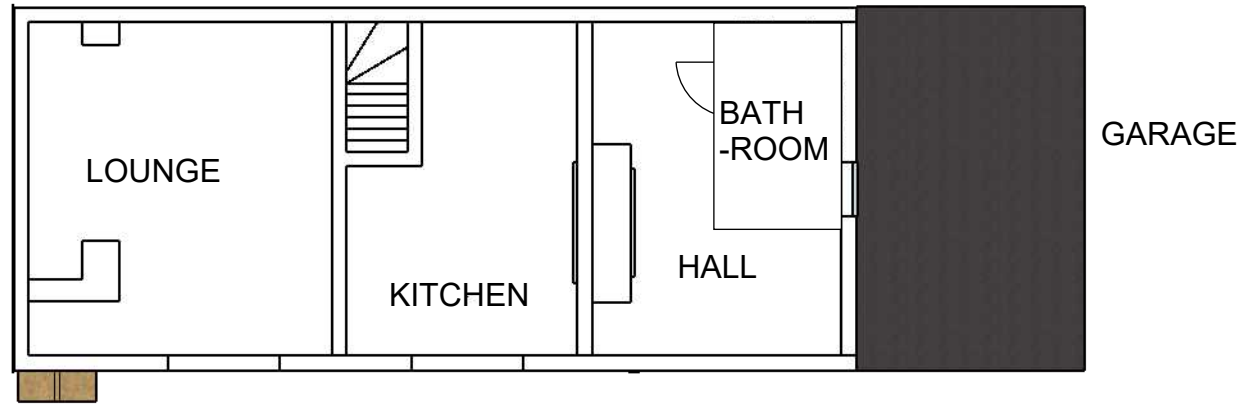

GROUND FLOOR

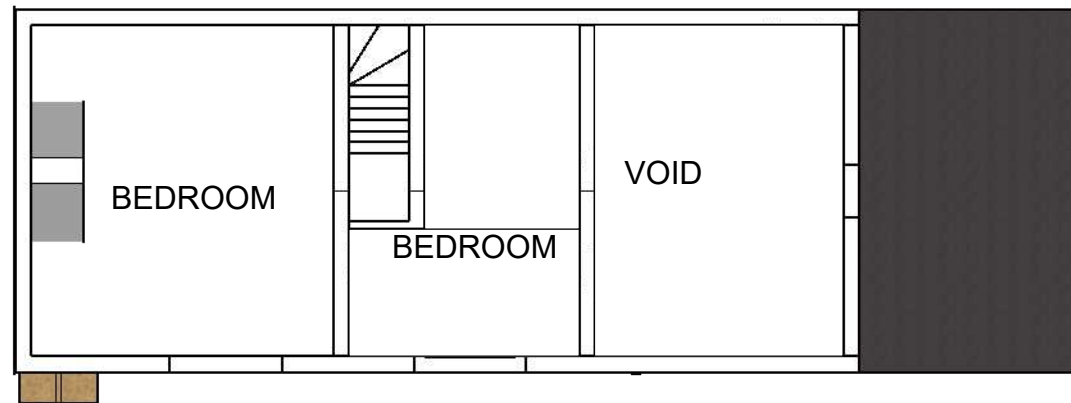

FIRST FLOOR

PROJECT
 HAWTHORN COTTAGE, BURWARDSLEY ROAD,
 TATTENHALL, CH3 9NS

CLIENT
 L HAINES

TITLE
 EXISTING GROUND & FIRST FLOOR PLANS

DATE
 AUGUST 22

SCALE
 1:100 @A3

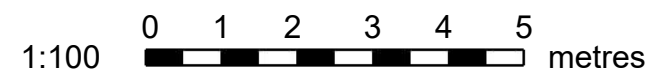

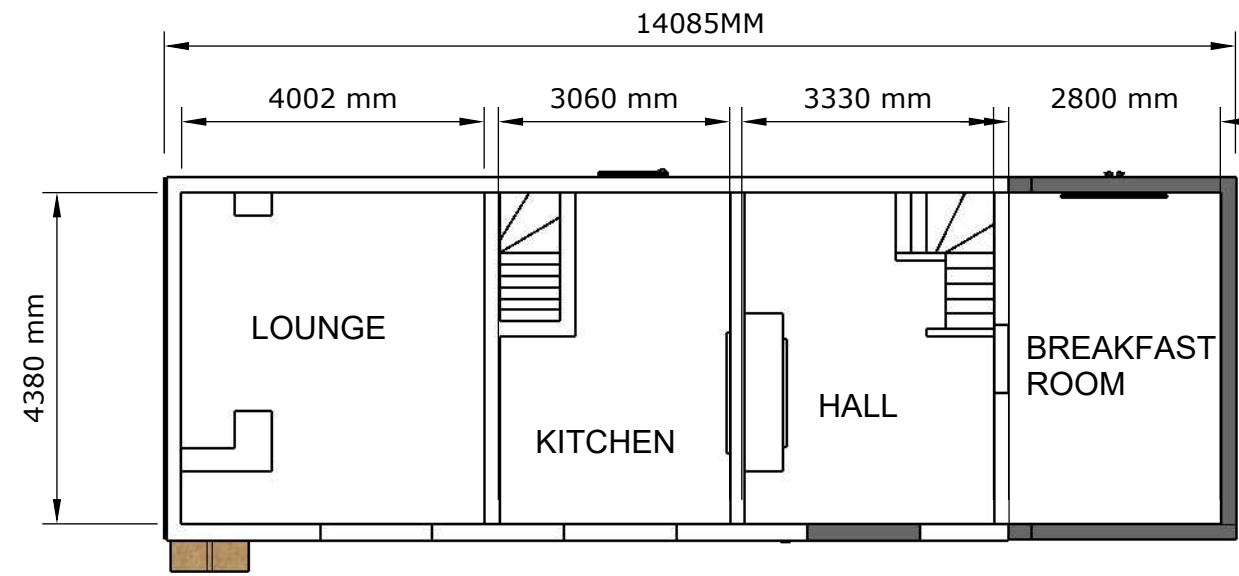

GROUND FLOOR

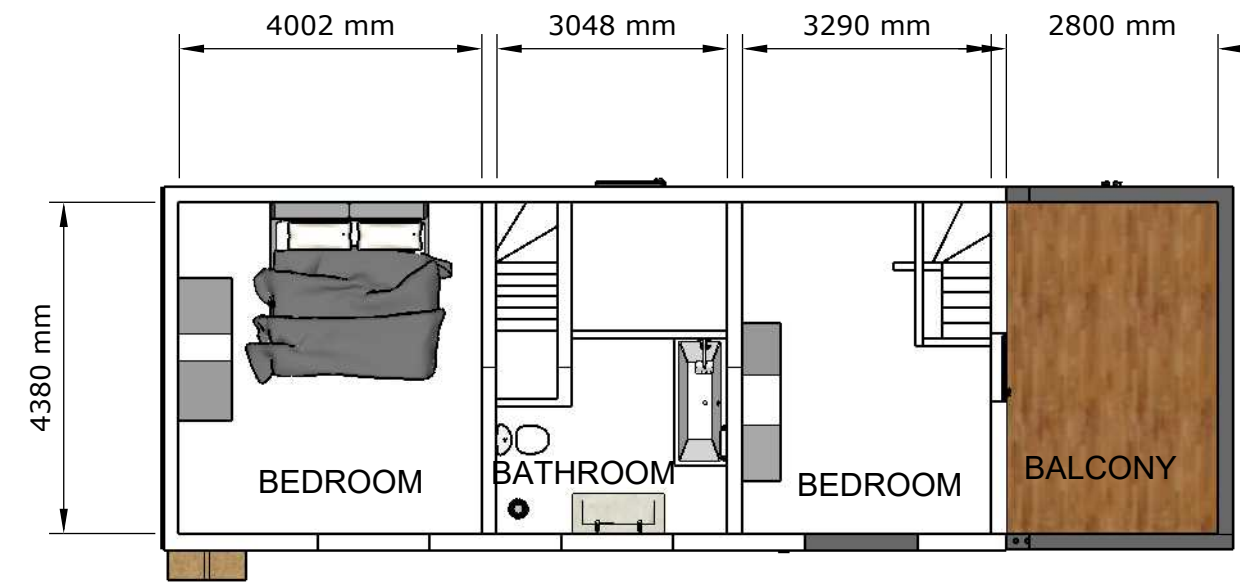

FIRST FLOOR

PROJECT HAWTHORN COTTAGE, BURWARDSLEY ROAD, TATTENHALL, CH3 9NS	CLIENT L HAINES	TITLE PROPOSED GROUND & FIRST FLOOR PLANS
--	---------------------------	---

DATE AUGUST 22	SCALE 1:100 @A3
--------------------------	---------------------------



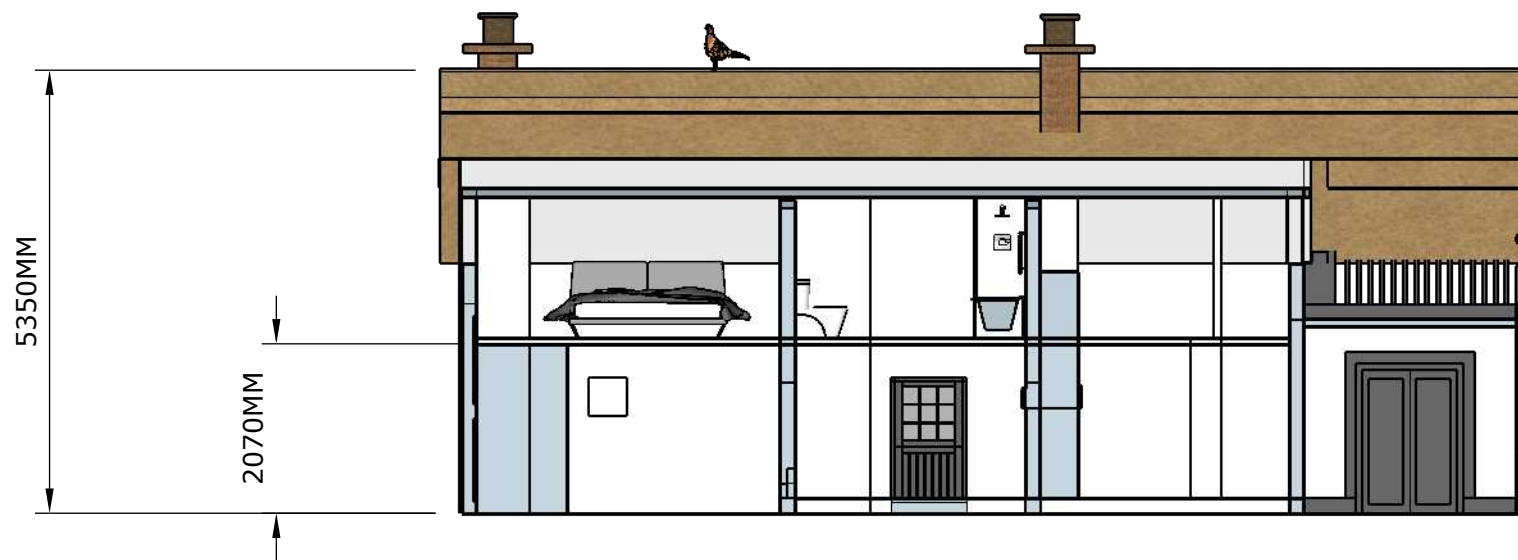

PROJECT
 HAWTHORN COTTAGE, BURWARDSLEY ROAD,
 TATTENHALL, CH3 9NS

CLIENT
 L HAINES

TITLE
 PROPOSED SECTION

DATE
 AUGUST 22

SCALE
 1:100 @A3

1:100 0 1 2 3 4 5 metres

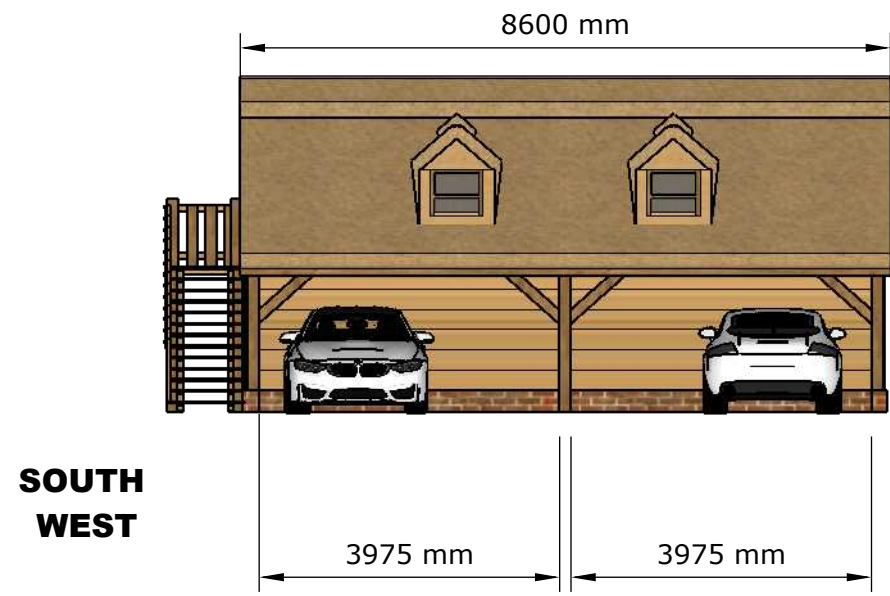

**SOUTH
WEST**

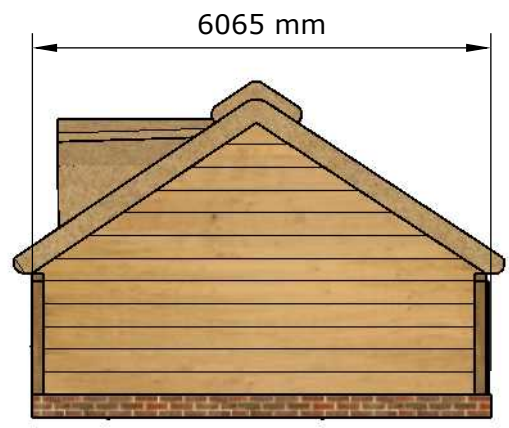

**SOUTH
EAST**

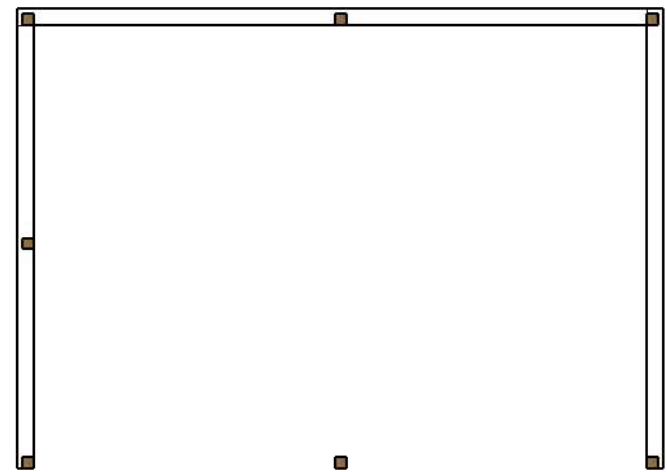

FLOOR PLAN



**NORTH
EAST**



**NORTH
WEST**

PROJECT
HAWTHORN COTTAGE, BURWARDSLEY ROAD,
TATTENHALL, CH3 9NS

CLIENT
L HAINES

TITLE
PROPOSED SECTION

DATE
AUGUST 22

SCALE
1:100 @A3

