

# VELUX roof window GGL

Glazing 70

**VELUX®**



The original VELUX top-operated, centre-pivot roof window GGL is easy to operate and gives you the freedom to place furniture underneath. The innovative top control bar allows you to install the window at a lower position to get an excellent view while standing and even when seated.

- Open the top control bar to the ventilation position for fresh air through a closed window.
- Easily rotate the window 180° for safe cleaning of the outer glass from the inside.
- The glazing comes standard with premium features like safety lamination, toughened glass, UV filter and our unique rain noise reduction.
- Easily open and close the roof window – even with furniture placed underneath.
- Removable and cleanable ventilation filter protects your home from dust and insects while ventilating.
- Quickly and easily add blinds by simply clicking them into the pre-fitted brackets.
- Upgrade to a remote-controlled mains- or solar-powered motor for extra convenience.



## Application guidance operation method

---

The window can be installed in roof pitches between 15° and 90° to the horizontal.



Manually top-operated, centre-pivot roof windows make it possible to place furniture directly below the window without obstructing the window's operation. We recommend an installation height that allows for a clear sight line to the outside from both a standing and seated position. Please note that the optimum window height depends on the roof pitch.

## Available sizes and daylight area

	472 mm	550 mm	660 mm	780 mm	942 mm	1140 mm	1340 mm
550 mm					GGL PK25 0.27 m <sup>2</sup>		
624 mm				GGL MK27 0.26 m <sup>2</sup>			
698 mm		GGL CK01 0.19 m <sup>2</sup>				GGL SK01 0.48 m <sup>2</sup>	
778 mm		GGL CK02 0.22 m <sup>2</sup>					
978 mm	GGL BK04 0.23 m <sup>2</sup>	GGL CK04 0.29 m <sup>2</sup>	GGL FK04 0.38 m <sup>2</sup>	GGL MK04 0.47 m <sup>2</sup>	GGL PK04 0.60 m <sup>2</sup>		GGL UK04 0.91 m <sup>2</sup>
1178 mm		GGL CK06 0.37 m <sup>2</sup>	GGL FK06 0.47 m <sup>2</sup>	GGL MK06 0.59 m <sup>2</sup>	GGL PK06 0.75 m <sup>2</sup>	GGL SK06 0.95 m <sup>2</sup>	GGL UK06 1.15 m <sup>2</sup>
1398 mm			GGL FK08 0.58 m <sup>2</sup>	GGL MK08 0.72 m <sup>2</sup>	GGL PK08 0.92 m <sup>2</sup>	GGL SK08 1.16 m <sup>2</sup>	GGL UK08 1.40 m <sup>2</sup>
1600 mm				GGL MK10 0.85 m <sup>2</sup>	GGL PK10 1.07 m <sup>2</sup>	GGL SK10 1.35 m <sup>2</sup>	GGL UK10 1.63 m <sup>2</sup>
1800 mm				GGL MK12 0.97 m <sup>2</sup>			

All measurements are in mm. ( ) = Effective daylight area, m<sup>2</sup>



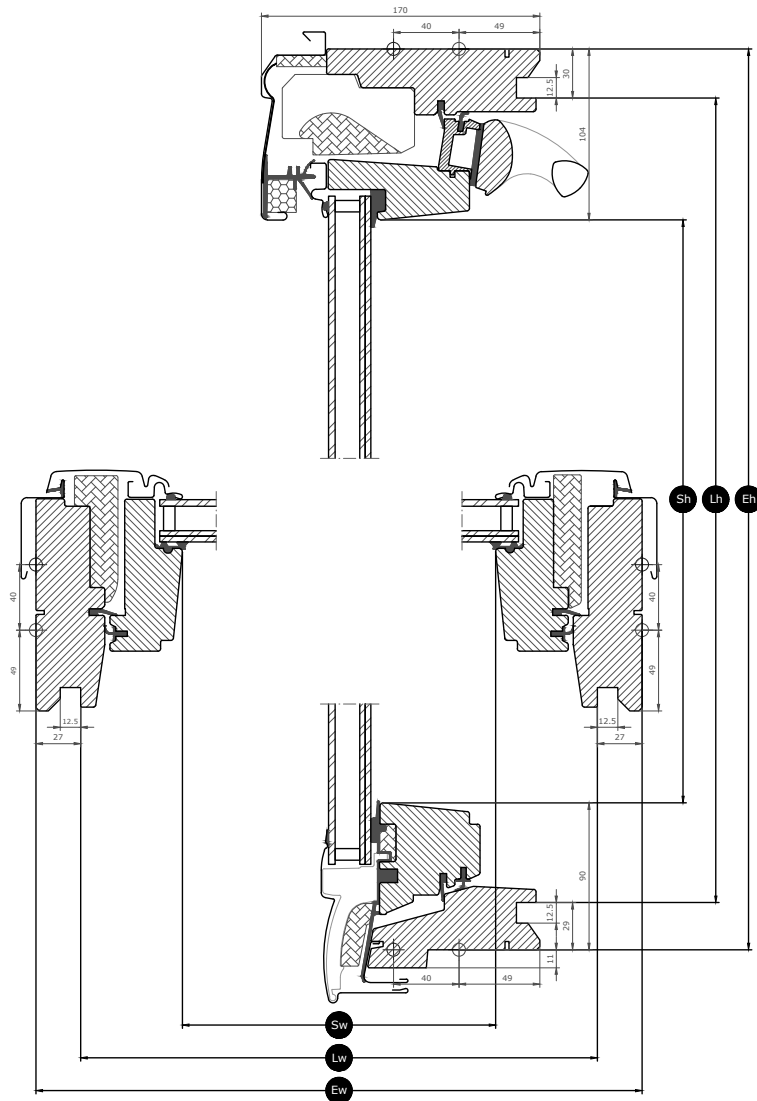





# Cross section dimensions

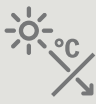

Width		BK--	CK--	FK--	MK--	PK--	SK--	UK--
Sw	Sash aperture width	293	371	481	601	763	961	1161
Lw	Distance between lining grooves, width	417	495	605	725	887	1085	1285
Ew	External frame width	472	550	660	780	942	1140	1340

Height		--01	--02	--04	--06	--08	--10	--12	--25	--27
Sh	Sash aperture height	504	584	784	984	1204	1406	1606	356	430
Lh	Distance between lining grooves, height	639	719	919	1119	1339	1541	1741	491	565
Eh	External frame height	698	778	978	1178	1398	1600	1800	550	624

## Glazing features

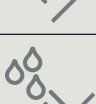
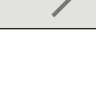
Glazing 70		
	<b>Heat insulation</b> The low energy glazing unit reduces heat loss through the window and enhanced indoor comfort.	$U_g = 1.0$
	<b>Solar gain</b> In colder climates and in rooms with large window areas, solar gain provides a better indoor climate during winter periods.	<b>0.46</b>
	<b>Solar protection</b> In warm climates and in rooms with large window areas, a sun protective glazing unit provides a better indoor climate during summer periods.	★★★★☆
	<b>Security</b> Thicker laminated inner glass increases resistance to manual attack (burglary).	★★★★☆
	<b>Safety lamination</b> Prevents glass from falling into the room in case of accidental breakage.	✓
	<b>Toughened glass</b> Adds strength to the outer glass surface to protect from wayward balls and extreme weather such as heavy storms and hail.	✓
	<b>UV filter</b> Protects your interior furnishings from fading due to the sun's harmful UV rays.	✓
	<b>Rain noise reduction</b> Rain noise reduction creates a barrier between the window and the weather outside for undisturbed moments during rainy days – or nights.	✓
	<b>Easy-to-clean</b> Dirt-repellent coating lets you spend less time cleaning and more time enjoying the view.	
	<b>Anti-dew</b> The anti-dew coating significantly reduces the days with dew on the outer glass and thus gives you a clear view.	

### Glazing structure

Glazing unit	Variant composition
Double-glazed	6.8 mm laminated float glass - 16 mm Argon - 4 mm toughened glass

## Technical values for the window

---

Overview of technical values for the product, covering among other, CE marking in accordance with EN 14351-2.

Window characteristics	Performance
Thermal transmittance	1.3 W/(m <sup>2</sup> K)
Light transmittance	0.68
Total solar energy transmittance	0.46
Sound insulation	35(-1;-3)
Air permeability	4
External fire performance - British	AC
External fire performance - European	npd
Impact resistance	3
Load-bearing capacity of safety devices	√
Reaction to fire	C-s1,d2
Resistance to snow load	See glazing composition
Resistance to wind load	C3 (>SK08: NPD)
Water tightness	E900

NPD: No performance determined

## Visible features

---



### Control bar

The ergonomic aluminum control bar allows effortless opening and closing of the window. It can also lock the ventilation flap in the ventilation position.

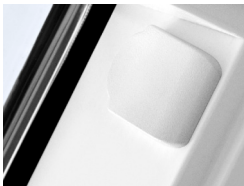

### Blind bracket, manual

Easily install blinds on the window without the need for extra tools. Simply click on the blind in the pre-fitted brackets.



### Ventilation flap

The full-width ventilation flap can be used for ventilation even with a closed window. The ventilation flap is connected to the top sash with the lock casing.



### Frame hinge, centre-pivot, side

Durable hinge design allows for reliable operation and enables the sash to be rotated for easy cleaning of the outer glass.



### Interior insulation, frame top sides

Innovative ThermoTechnology™ insulation is integrated into the top frame sides of the window to increase energy-efficiency.



### Barrel bolt

The barrel bolt can be placed into the integrated barrel bolt bushing to secure the window for cleaning of outer glass surface or for safe ventilation.



### Headlock

When closed, the window is locked firmly into place by the headlock.



### Data plate

Every VELUX roof window has a unique data plate with information that can be used to look up CE marking documentation, when purchasing accessories or in case of service or replacement.

## Interior finish

Material Description	Clear lacquer Finished with triple coat, clear lacquered.	White-painted Finished with triple coat, white painted.
Colour code NCS, inner surface	No colour code	S 0500-N
Colour code nearest RAL, inner surface	No colour code	9003

## Exterior covers

Material Description	Aluminium, dark grey Dark grey	Titanium zinc	Untreated copper
Colour code NCS, outer surface	S 7500-N	No colour code	
Colour code nearest RAL, outer surface	7043	No colour code	

## Cleaning and maintenance

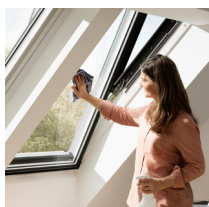

To clean the outer glass surface from the inside, rotate sash manually and secure in cleaning position with barrel bolts.



VELUX repair and maintenance kits are available.

## Guarantee period



The full terms and conditions of the VELUX Product Guarantee are available on our website [www.velux.co.uk](http://www.velux.co.uk) or [www.velux.ie](http://www.velux.ie)



## Flashings and installation products

---

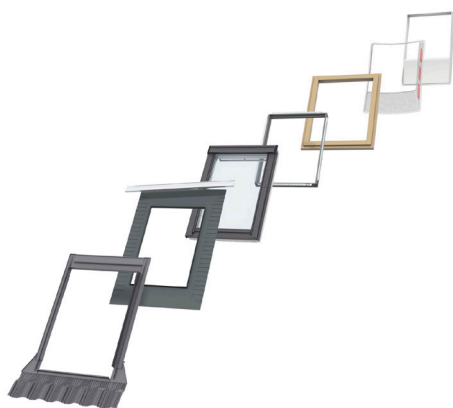

### **Flashings**

Install the VELUX roof window in virtually any roofing material by using genuine VELUX flashing solutions. Our flashings are designed specifically for the exact size and shape of the roof windows to create perfect, watertight fit. Flashings can also be used to combine multiple roof windows.

### **Installation products**

Ensure a proper installation and an air- and watertight connection between the window and roof with VELUX installation products. All installation products are designed to perfectly fit the roof window for a reliable and durable result.

## Blinds, awnings and shutters

---

Complete the VELUX roof window installation with roller shutters and awning blinds for heat protection and interior blinds for light dimming, blackout and insect protection. Choose from a wide range of manually operated or remote-controlled products that are made to fit the particular window type and size. Please contact your local VELUX sales company for more details about compatibility.

## Further information

---

We reserve the right to make technical changes.

For more information on our products, please visit <https://www.velux.co.uk> or <https://www.velux.ie>.