

SIGNAGE SPECIFICATIONS

- Item A - 2no. fascias with FST medium extrusion. F&B Hague Blue panels & F&B White Tie letters. 6000mm x 550mm
- Item B - 11no. 30w LED floodlights
- Item C - 13no. Black up/down spotlights
- Item E - New pictorial sign 900mm x 1200mm with 3D paddles. 825mm cartouche and new LED troughlights.
- Item F - Arched steelwork to be replaced, new 115mm high housename letters.
- Sign G - Refurbished existing cartouches
- Sign H - 1no. 800mm x 1400mm amenity panel with medium extrusion and 3D paddles



Item A



Item H

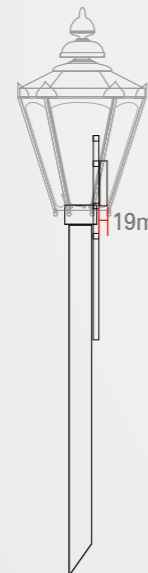

Item F



Item E
Pictorial panel

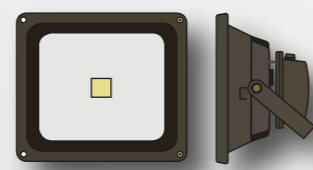
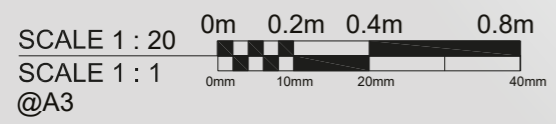
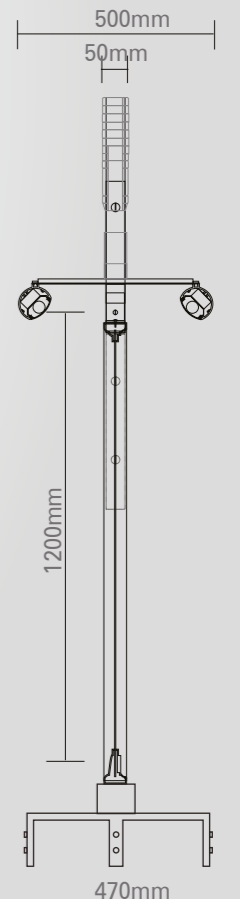
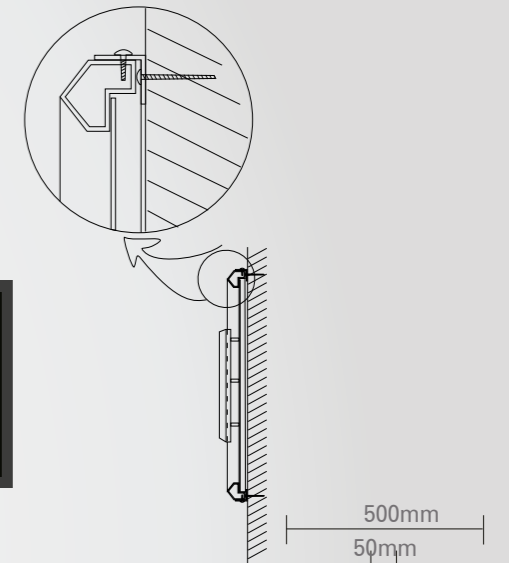
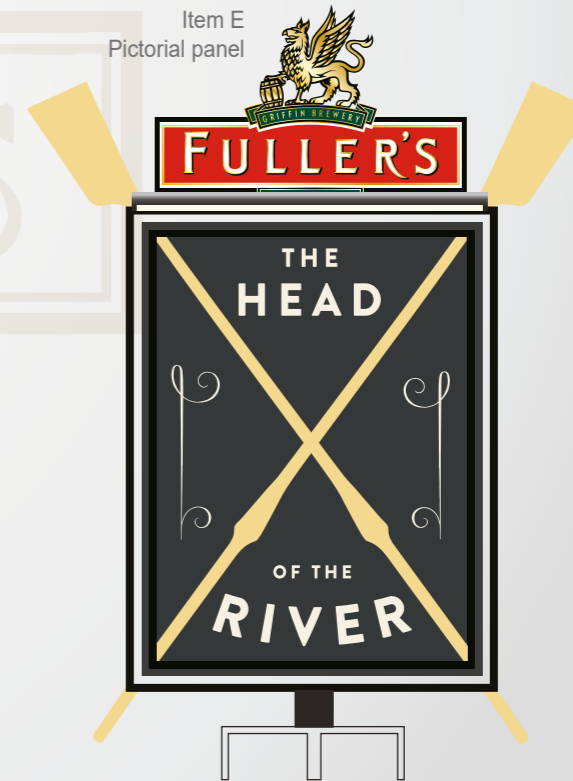

Item B
30w LED Floodlight - 1:10



Item C
Up/Down Spotlights



This scheme is a visual representation of our signage proposal. Sizes, colours and physical attributes of the actual signage may vary due to the limitations of the manufacturing process.
This document is the property of Omega Signs Ltd. and must not be passed to third parties without prior consent. Any unauthorised use of this document will result in a design fee being charged.
Copyright © Omega Signs 2013.

Client Fullers

Project The Head Of The River

Address Oxford

Signage Colours

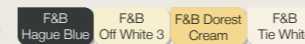

Building Colours



Typeface Futura Hv BT / Snell Blk BT

Created 11-01-16 No. 23665PL01

Amended by KLV Designer TF Issue 6

Date 03-03-17 Approved J Redpath Page 2 of 10