















Standard Unit Dimensions:

Width: 715mm
Height: 800mm
Diameter: 48.3mm

Recommended spacing between cycle stands:

800mm

Colours/Finishes:

The colours shown are a guide only.
Please check a colour chart to see the actual colour.

Product Information

The Sheffield Cycle Stand is recommended by the national cycling associations, this best selling tubular cycle stand allows the bike to be secured in a variety of ways. Simple and easy to install this cycle stand is available in a variety of different sizes, fixings and finishings. Thus allowing this best selling cycle stand to complement any external environment, and pre-existing street furniture suite.

Features

- Hot dipped galvanised to BS EN ISO 1461:2009
- Recommended by the national cycling associations
- Available in a variety of different sizes, fixings and finishings
- Complements any external environment
- Available root fixed or baseplated

Materials Used

- Framework - Mild Steel

Finish Options

- Galvanised to BS EN ISO 1461:2009
- Galvanised to BS EN ISO 1461:2009 & Polyester Powder Coated
- Stainless Steel Grade 304
- Stainless Steel Grade 316
- Duracast™ Polyurethane version

Broxap Limited, Rowhurst Industrial Estate, Chesterton, Newcastle-under-Lyme, Staffordshire, ST5 6BD T: 01782 564411 E: info@broxap.com W: www.broxap.com



ISO 9001
Quality
Management
Systems
CERTIFIED

ISO 14001
Environmental
Management
CERTIFIED

ISO 45001
Occupational
Health and Safety
Management
CERTIFIED



Guarantees, Warranties, Design-Life and Life-Expectancies

- 34 year (min) life expectancy for Hot Dip Galvanizing
- 8-10 year life expectancy on standard powder coatings
- 10-15 year life expectancy on Duplex (Zinc Coated) powder coatings
- 12 months' warranty* on parts & labour

*Maintenance and other qualifying criteria apply

Options

- Stands also available in junior size - See Sheffield Junior Cycle Stand for details
- Polyester powder coating to RAL and BS colours
- Available in a range of different sizes, fixings and finishings

Diagram

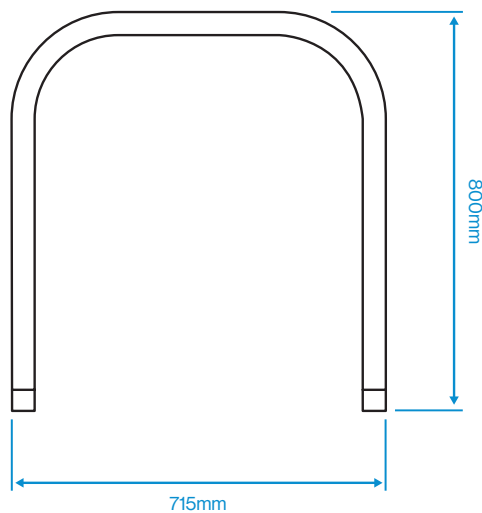

Standard Unit Dimensions:

Width: 715mm
Height: 800mm
Diameter: 48.3mm

Recommended spacing between cycle stands:

800mm

Colours/Finishes:

Galvanised Only	RAL 9006 White Aluminium	RAL 7016 Anthracite Grey
BS 4800 10 A 07 Nimbus Grey	RAL 3020 Traffic Red	RAL 9005 Jet Black
BS 4800 14 C 39 Holly Green	RAL 1023 Traffic Yellow	BS 4800 00 A 05 Goose Grey
RAL 5015 Mid Blue	RAL 5013 Dark Blue	RAL 9016 Traffic White

The colours shown are a guide only.
Please check a colour chart to see the actual colour.

Broxap Limited, Rowhurst Industrial Estate, Chesterton, Newcastle-under-Lyme, Staffordshire, ST5 6BD T: 01782 564411 E: info@broxap.com W: www.broxap.com



ISO 9001
Quality Management Systems
CERTIFIED

ISO 14001
Environmental Management
CERTIFIED

ISO 45001
Occupational Health and Safety Management
CERTIFIED

