

**SITE**  
**ACKNOWLEDGEMENT OF ORDER**

Job No. : D9862F

**Invoice To:**

Mr R Evans  
Lees Hill  
South Warnborough  
Hampshire  
RG29 1RQ

Tel No: 07740 435001

**Delivery To:**

Mr R Evans  
Lees Hill  
South Warnborough  
Hampshire  
RG29 1RQ

Quotation No. GT/B44955G

Rep: Rob Sutton

Order No. Deposit Rec'd

Terms. 25% / 70% / 5%

Est. Delivery: w/e 15.12.23

Finish: *Fully Finished Osmo 420*

Glazing Bead: Iroko Splayed & Rounded

**Revision 1:** GD03 & GD04 Repositioned behind oak frame  
Threshold detail to GD02 to GD04 changed

**Revision 2:** Cill Extension Added to GD03 & GD04

**Revision 3:** All Trykvents Changed to Grey

**Revision 4:** Frame Sizes Changed Follow Late Measure

**The following must be considered when giving your approval:**

- \* ALL ELEVATIONS ARE VIEWED FROM OUTSIDE.
- \* POINT OF ARROW DENOTES HINGE POSITION.
- \* ATTENTION TO BE GIVEN TO THE PROPORTIONS OF ANY LEAD OR GLAZING BARS.
- \* CLIENT IS FULLY AWARE OF THE LIMITED DURABILITY OF THEIR CHOSEN FINISH.
- \* SIZES THAT HAVE BEEN MEASURED ON SITE ARE OUR RESPONSIBILITY.
- \* APERTURES FORMED TO AGREED SIZES ARE THE CLIENTS RESPONSIBILITY.
- \* PLEASE CHECK THAT WE HAVE INTERPRETED YOUR REQUIREMENTS CORRECTLY.
- \* NO LIABILITY WILL BE ACCEPTED FOR ANY ERRORS THAT MAY OCCUR.

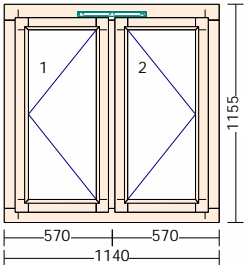
Item	Quantity	Description
1	1 Piece(s)	<div style="display: flex; align-items: flex-start;"> <div style="margin-right: 20px;">  </div> <div> <p>Location: GW01 - HOME OFFICE</p> <p>Product: Cheriton Flush Casement Window</p> <p>Timber: Iroko</p> <p>Finish: Fully Finished 3 Coat Osmo 420</p> <p>Sash: Flush Casement</p> <p>Frame: Splayed &amp; Round</p> <p>Sash: Splayed &amp; Round</p> <p>W/Board: No Window Board Groove</p> <p>Gasket: Brown</p> <p>Options: Tear Drop Hardex Graphite Handle Side Hung Trojan Egress Hinge Grey Trykvent Maco Rail Espag</p> <p>Glass: 4/16/4 Clear Tough Softcoat Low E Argon Filled</p> <p>Spacer Bar: Grey Warm Edge</p> <p>Weight (kg): 59</p> <p>Dims: 1140x1155</p> </div> </div>

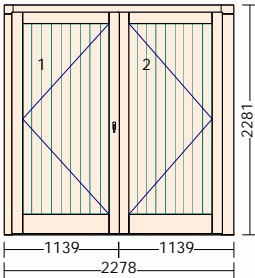
Item	Quantity	Description
2	1 Piece(s)	<p>Location: GW02 - GYM/STUDIO</p> <p>Product: Cheriton Flush Casement Window</p> <p>Timber: Iroko</p> <p>Finish: Fully Finished 3 Coat Osmo 420</p> <p>Sash: Flush Casement</p> <p>Frame: Splayed &amp; Round</p> <p>Sash: Splayed &amp; Round</p> <p>W/Board: No Window Board Groove</p> <p>Gasket: Brown</p> <p>Options: Tear Drop Hardex Graphite Handle Grey Trykvent Top Hung Friction Hinge Maco Rail Espag</p> <p>Glass: 4/16/4 Clear Tough Softcoat Low E Argon Filled</p> <p>Spacer Bar: Grey Warm Edge</p> <p>Weight (kg): 62</p> <p>Dims: 2035x534</p>
		
3	1 Piece(s)	<p>Location: GW03 - STORE</p> <p>Product: Cheriton Flush Casement Window</p> <p>Timber: Iroko</p> <p>Finish: Fully Finished 3 Coat Osmo 420</p> <p>Sash: Flush Casement</p> <p>Frame: Splayed &amp; Round</p> <p>Sash: Splayed &amp; Round</p> <p>W/Board: No Window Board Groove</p> <p>Gasket: Brown</p> <p>Options: Tear Drop Hardex Graphite Handle Side Hung Trojan Egress Hinge Grey Trykvent Maco Rail Espag</p> <p>Glass: 4/16/4 Clear Tough Softcoat Low E Argon Filled</p> <p>Spacer Bar: Grey Warm Edge</p> <p>Weight (kg): 91</p> <p>Dims: 1794x1160</p>
		
4	1 Piece(s)	<p>Location: GD01 - STORE</p> <p>Product: Cheriton Door Frame</p> <p>Timber: Iroko</p> <p>Finish: Fully Finished 3 Coat Osmo 420</p> <p>Sash: Outward Opening Door</p> <p>Frame: Splayed &amp; Round</p> <p>Sash: Tongue &amp; Groove</p> <p>W/Board: No Window Board Groove</p> <p>Gasket: Brown</p> <p>Options: Full Cylinder Mitre SSS Lever/Lever Handle on Rose SSS Oval Escutcheon Set HQ4 SSS Butt Hinge - Radius Corner Winkhaus Thunderbolt Door Lock Int. Bow Handle &amp; Dropbolt to 2nd Door Stormguard Garage Threshold Seal 250mm Satin Nickel Hook &amp; Eye</p> <p>Glass: Double T G &amp; V Boards</p> <p>Weight (kg): 104</p> <p>Dims: 2278x2281</p>
		

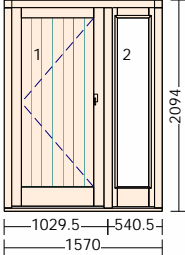
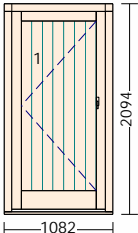
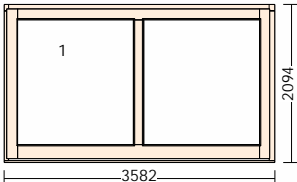
Item	Quantity	Description
5	1 Piece(s)	<p>Location: GD02 - GYM            Product: Cheriton Door Frame            Timber: Iroko            Finish: Fully Finished 3 Coat Osmo 420            Sash: Inward Opening Door                      Fixed Sidelight</p> <p>Frame: Splayed &amp; Round            Sash: Splayed &amp; Round            W/Board: No Window Board Groove            Gasket: Brown            Options: Full Cylinder                      Mitre SSS Lever/Lever Handle on Rose                      SSS Oval Escutcheon Set                      HQ4 SSS Butt Hinge - Radius Corner                      Winkhaus Thunderbolt Door Lock                      Coastal Black TSW Threshold</p> <p>Glass: Double T G &amp; V Boards / 6.8/14/4 Clear                      Laminated/Tough Softcoat Low E Argon Filled</p> <p>Spacer Bar: Grey Warm Edge            Weight (kg): 103            Dims: 1570x2094</p>
		
6	1 Piece(s)	<p>Location: GD03 - HOME OFFICE            Product: Cheriton Door Frame            Timber: Iroko            Finish: Fully Finished 3 Coat Osmo 420            Sash: Inward Opening Door</p> <p>Frame: Splayed &amp; Round            Sash: Tongue &amp; Groove            W/Board: No Window Board Groove            Gasket: Brown            Options: Full Cylinder                      Mitre Lever/Lever Handle on Rose                      SSS Oval Escutcheon Set                      HQ4 SSS Butt Hinge - Radius Corner                      Winkhaus Thunderbolt Door Lock                      Coastal Black TSW Threshold</p> <p>Glass: Double T G &amp; V Boards            Weight (kg): 56            Dims: 1082x2094</p>
		
7	1 Piece(s)	<p>Location: GD04 - HOME OFFICE            Product: Cheriton Door Frame            Timber: Iroko            Finish: Fully Finished 3 Coat Osmo 420            Sash: Outward Opening Door</p> <p>Frame: Splayed &amp; Round            Sash: Splayed &amp; Round            W/Board: No Window Board Groove            Gasket: Brown            Options: Black Coastal TSX Threshold</p> <p>Glass: 6.8/12/6 Clr Lam/Tgh LE AF/SC            Spacer Bar: Grey Warm Edge            Bar: Door Muntin Rail            Weight (kg): 258            Dims: 3582x2094</p>
		

Item	Quantity	Description
8  	1 Piece(s)	<b>Extra Over - Coastal Hardware</b> Part No: KM960C-SSS Description: BLU Mitre Lever Door Handle on 32mm Oval Rose Finish: Satin Stainless Steel Qty: 3 Pairs  Part No: KM045B-SSS Description: BLU Oval Escutcheon Finish: Satin Stainless Steel Qty: 3 Sets

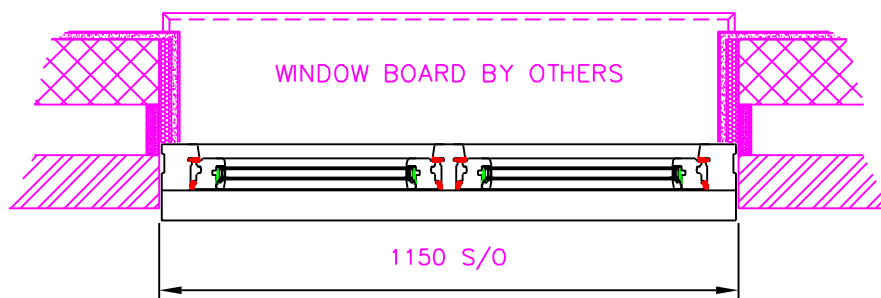
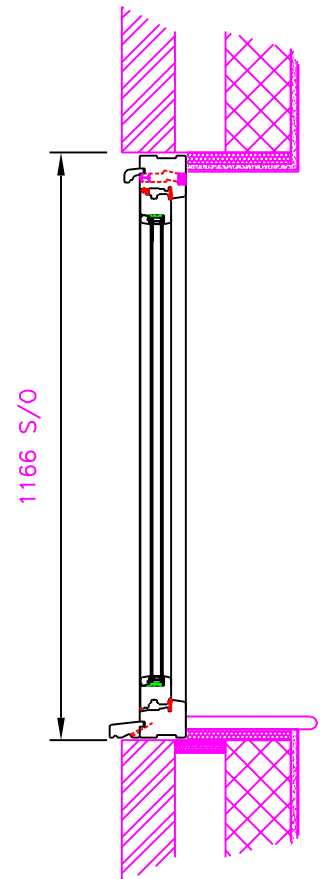
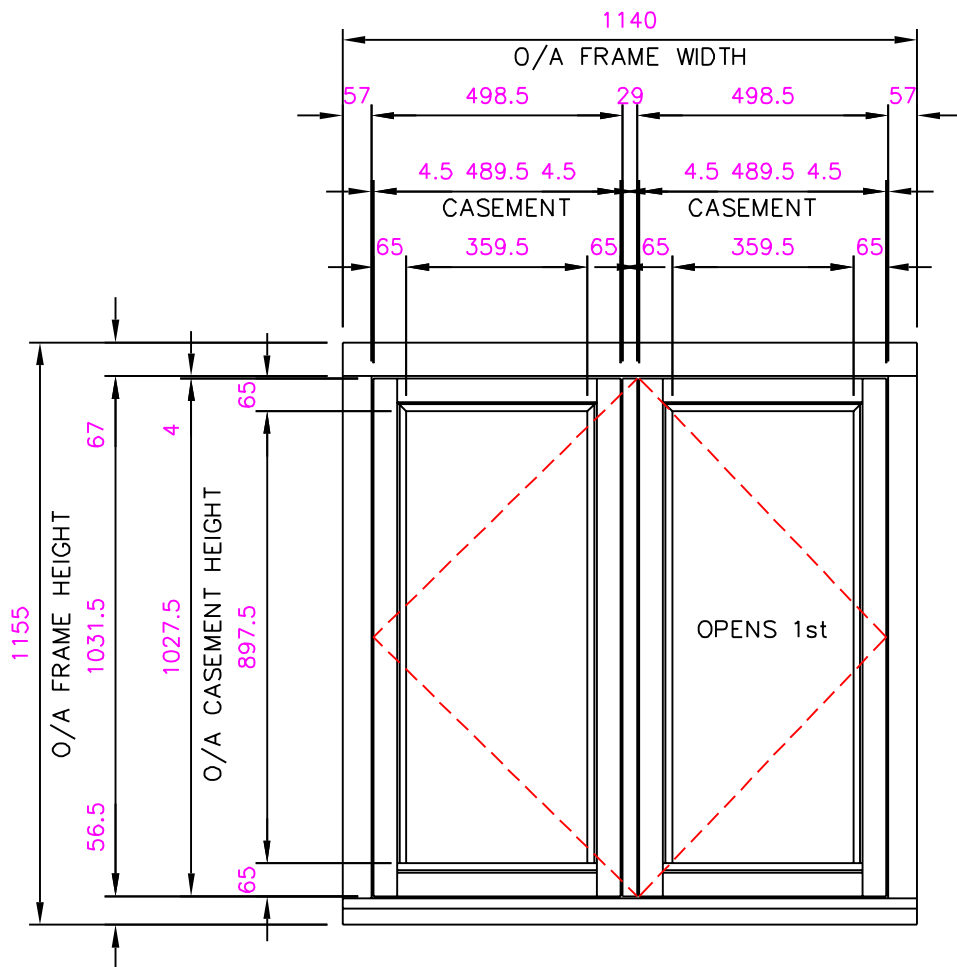

FALSE MULLION (R/HAND CASEMENT OPENS 1st)  
 HEAD, CILL & JAMBS ENLARGED TO ALLOW FOR INSULATED REVEALS  
 68x32mm CILL EXTENSION



CUSTOMER: MR R EVANS, LEES HILL, SOUTH WARNBOROUGH RG29 1RQ

DRAWING TITLE: GW01 - HOME OFFICE

DATE: 18.09.23

DRAWING NUMBER: D9862F.01

DRAWN BY: RS

SCALE: 1:1 @ A4

REVISION: -

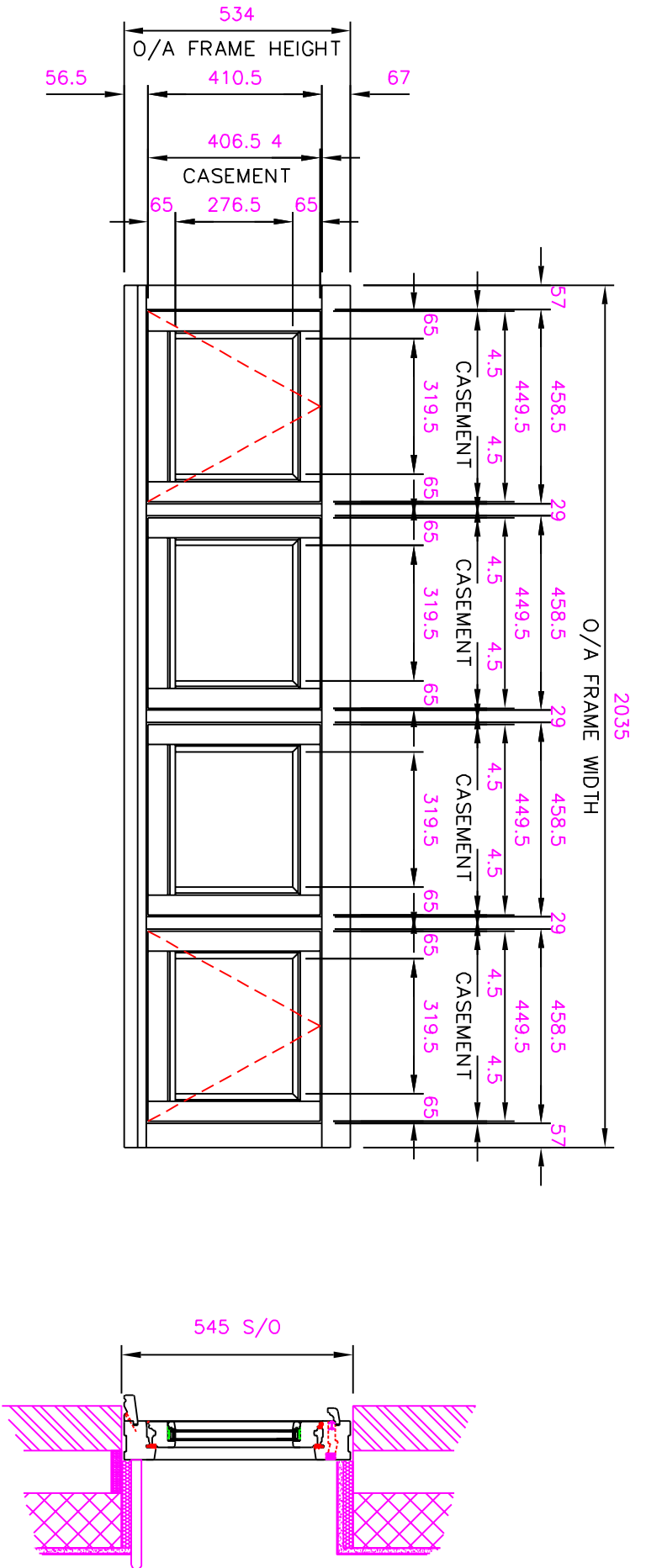

HEAD, CILL & JAMBS ENLARGED TO ALLOW FOR INSULATED REVEALS  
68x32mm CILL EXTENSION

	CUSTOMER: MR R EVANS, LEES HILL, SOUTH WARNBOROUGH RG29 1RQ		
	DRAWING TITLE: GW02 - GYM/STUDIO		
DRAWING NUMBER: D9862F.02	DRAWN BY: RS	SCALE: 1:15 @ A4	DATE: 18.09.23
			REVISION: -

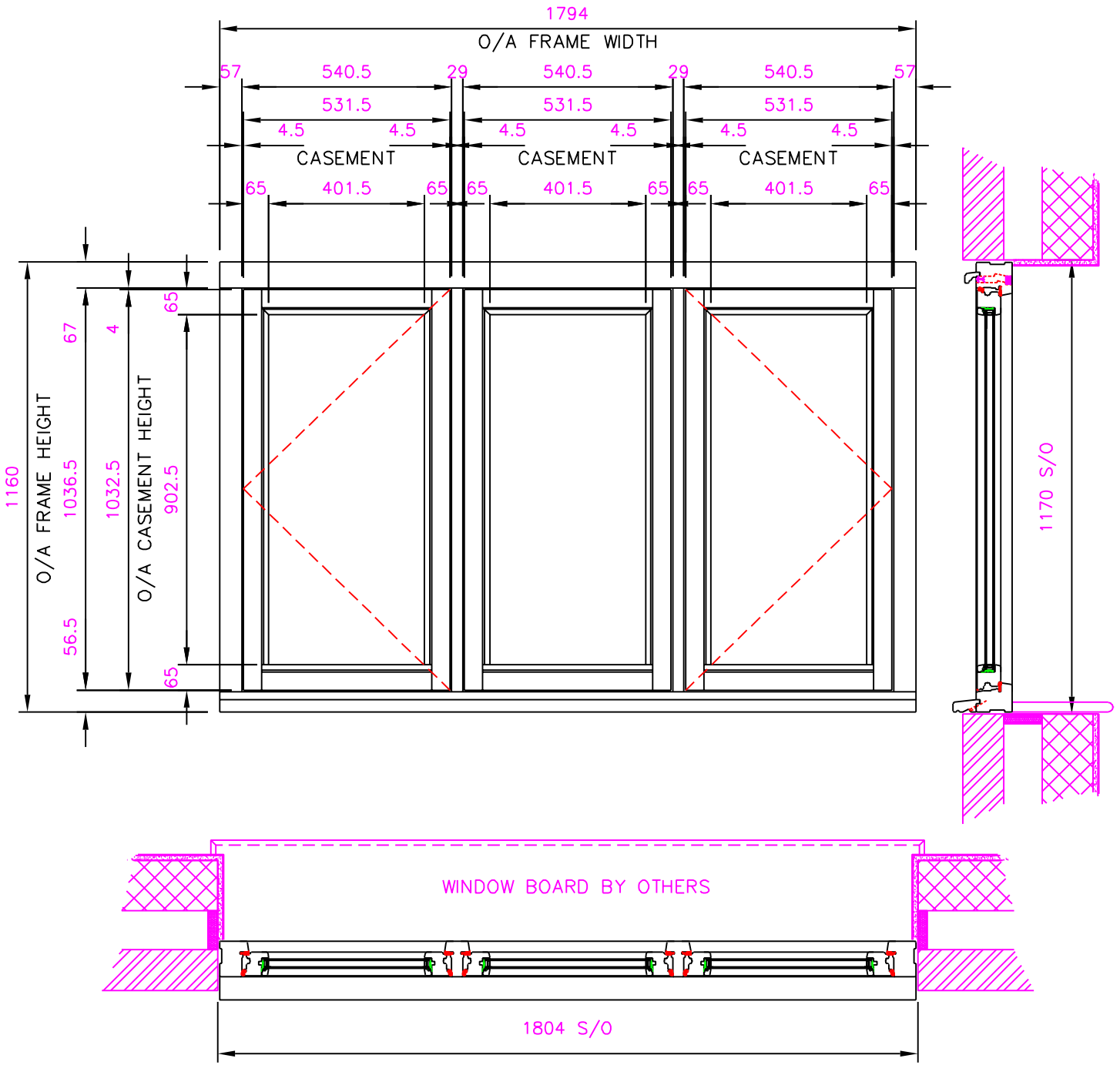

CUSTOMER: MR R EVANS, LEES HILL, SOUTH WARNBOROUGH RG29 1RQ			
DRAWING TITLE: GW03 - STORE			DATE: 30.10.23
DRAWING NUMBER: D9862F.03	DRAWN BY: RS	SCALE: 1:15 @ A4	REVISION: 1

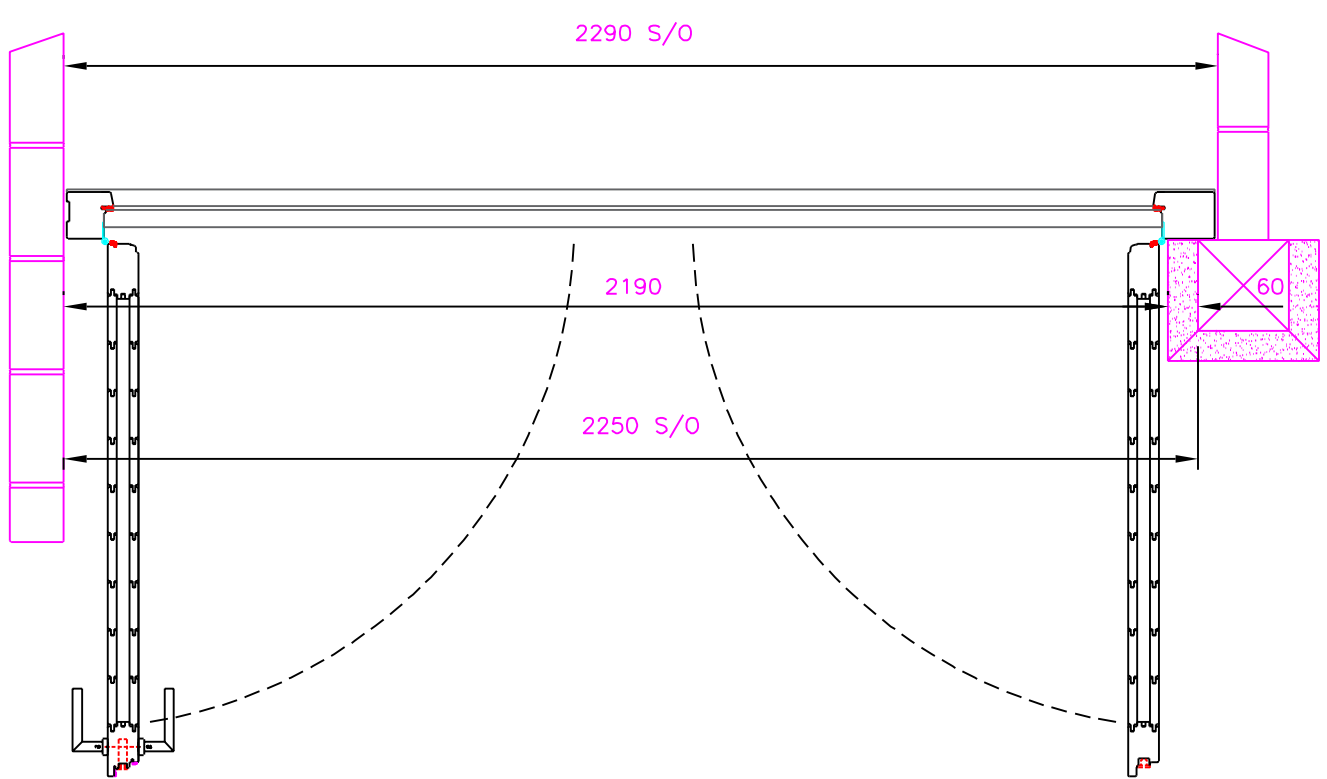
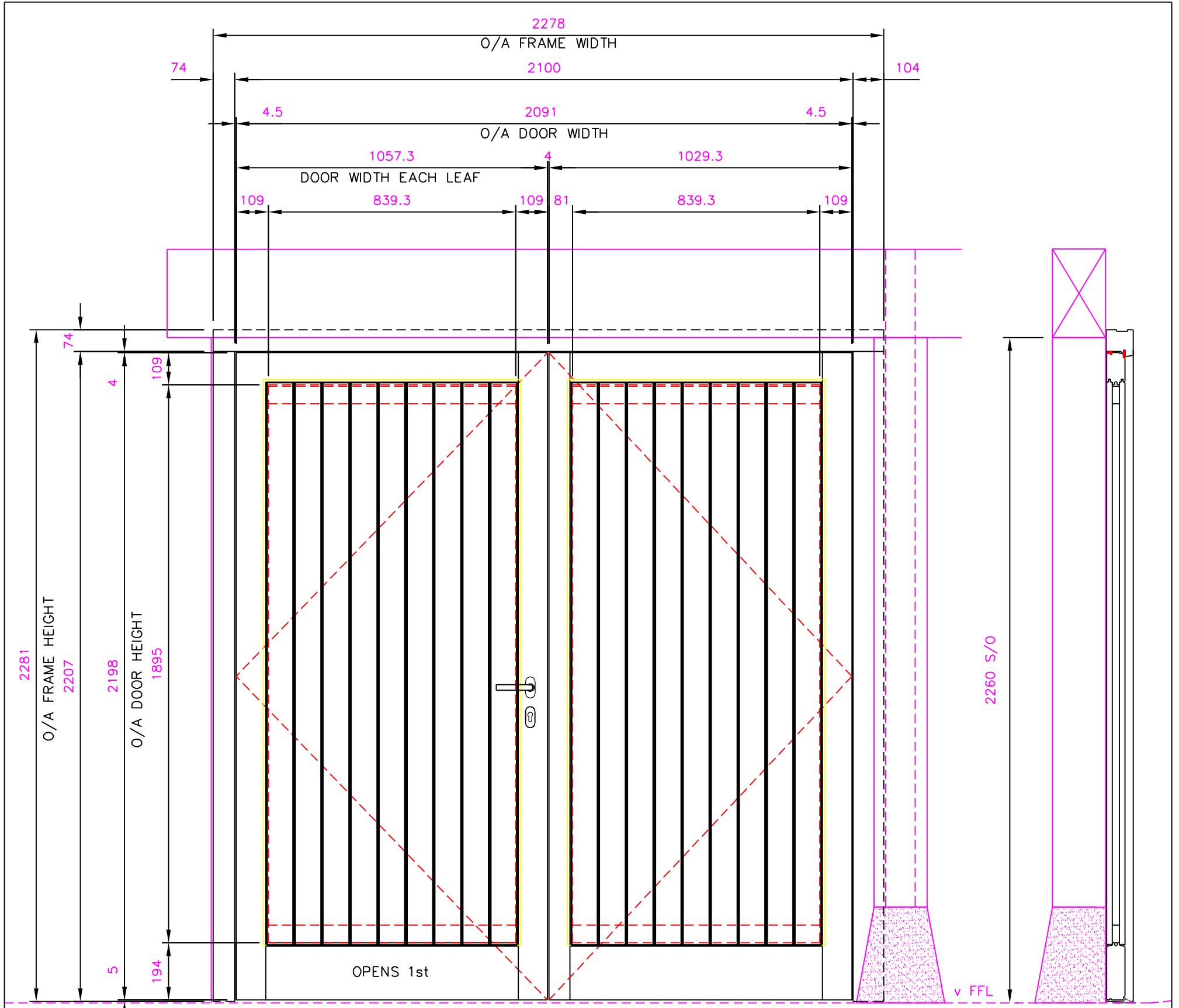

FRAME REPOSITIONED BEHIND OAK POST/SADDLE STONE (FRAMING ENLARGED)  
 75x15mm STORMGUARD GARAGE THRESHOLD SEAL (BONDED DIRECTLY TO SCREED)  
 SLAVE DOOR SECURED WITH FACE FIX BOW HANDLE BOLT & DROP BOLT

	CUSTOMER: MR R EVANS, LEES HILL, SOUTH WARNBOROUGH RG29 1RQ		
	DRAWING TITLE: GD01 - STORE		DATE: 30.10.23
	DRAWING NUMBER: D9862F.04	DRAWN BY: RS	SCALE: 1:15 @ A3
			REVISION: 2



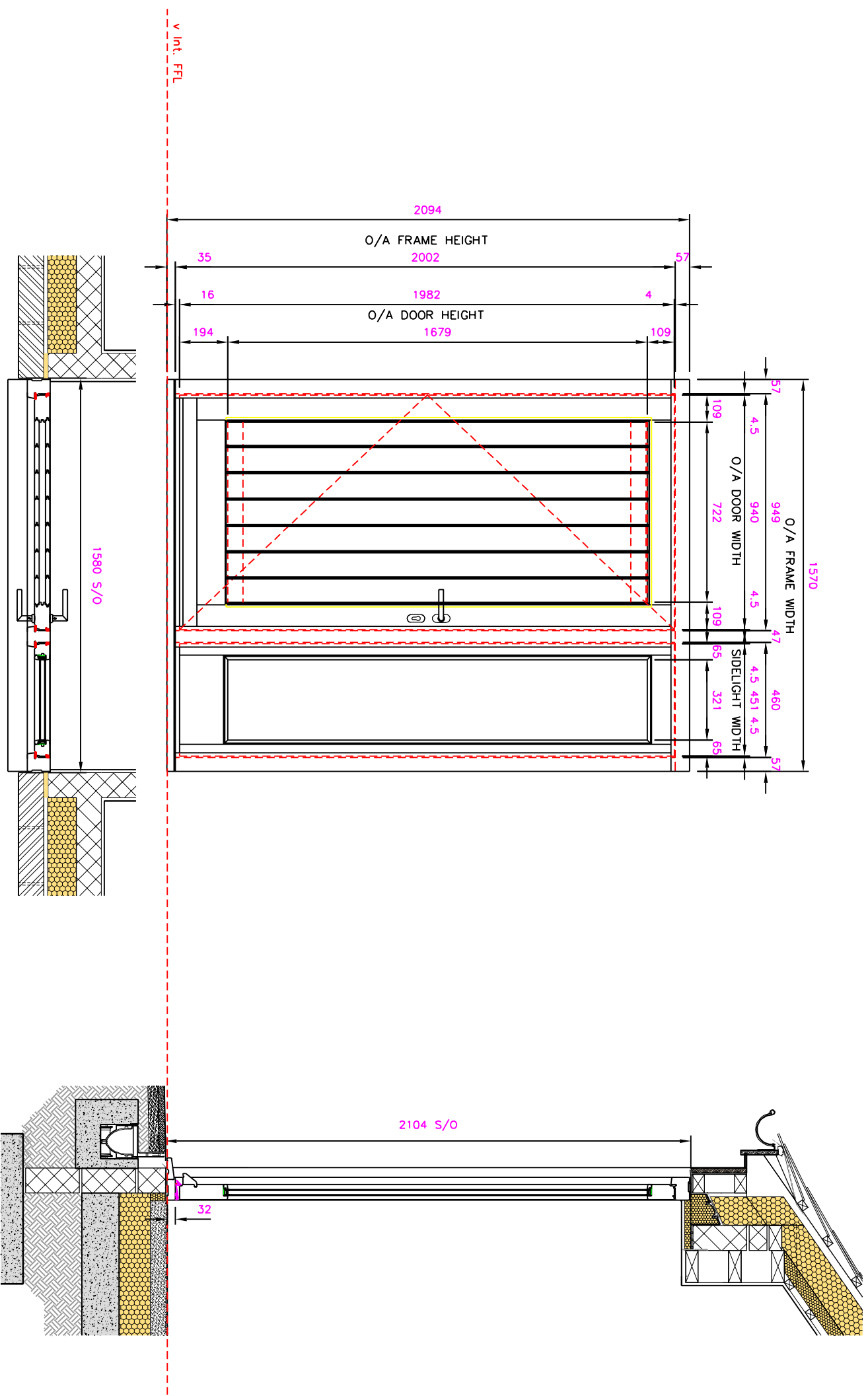

HEAD & JAMBS ENLARGED TO MAINTAIN CONTINUITY WITH OTHER FRAMES  
86x44mm CILL EXTENSION



CUSTOMER: MR R EVANS, LEES HILL, SOUTH WARBOROUGH RG29 1RQ		DATE: 26.09.23
DRAWING TITLE: GD02 - GYM		REVISION: 2
DRAWING NUMBER: D9862F.5	DRAWN BY: RS	SCALE: 1:20 @ A3

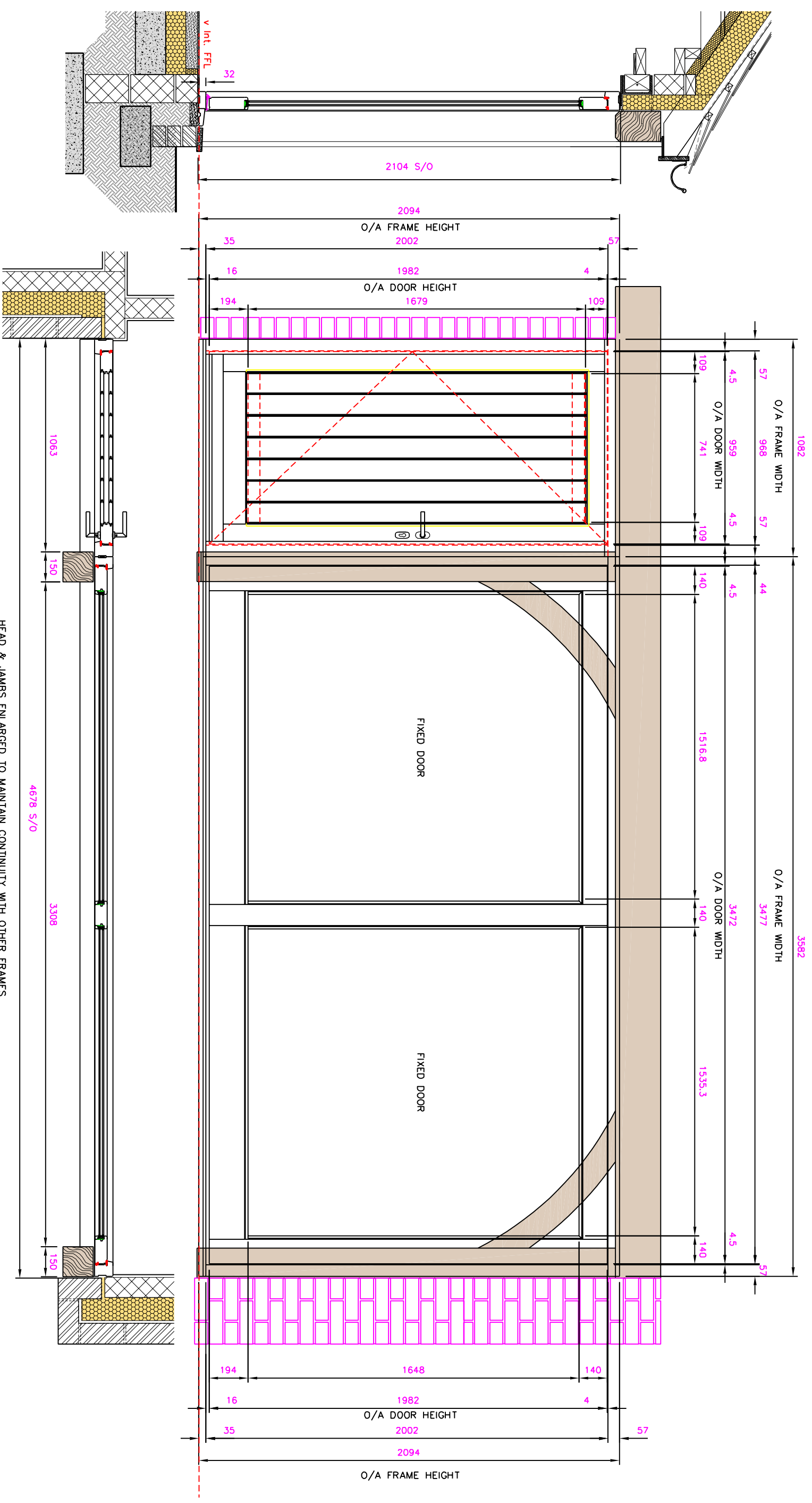

HEAD & JAMBS ENLARGED TO MAINTAIN CONTINUITY WITH OTHER FRAMES  
CONTINUOUS 86x32 OIL EXTENSION CUT AROUND POSTS

CUSTOMER: MR R EVANS, LEES HILL, SOUTH WARBOROUGH RG29 1RQ

DRAWING TITLE: GD03 & GD04 - HOME OFFICE

DRAWING NUMBER: D9862F.6 & 7

DRAWN BY: RS

SCALE: 1:20 @ A3

DATE: 30.10.23

REVISION: 4



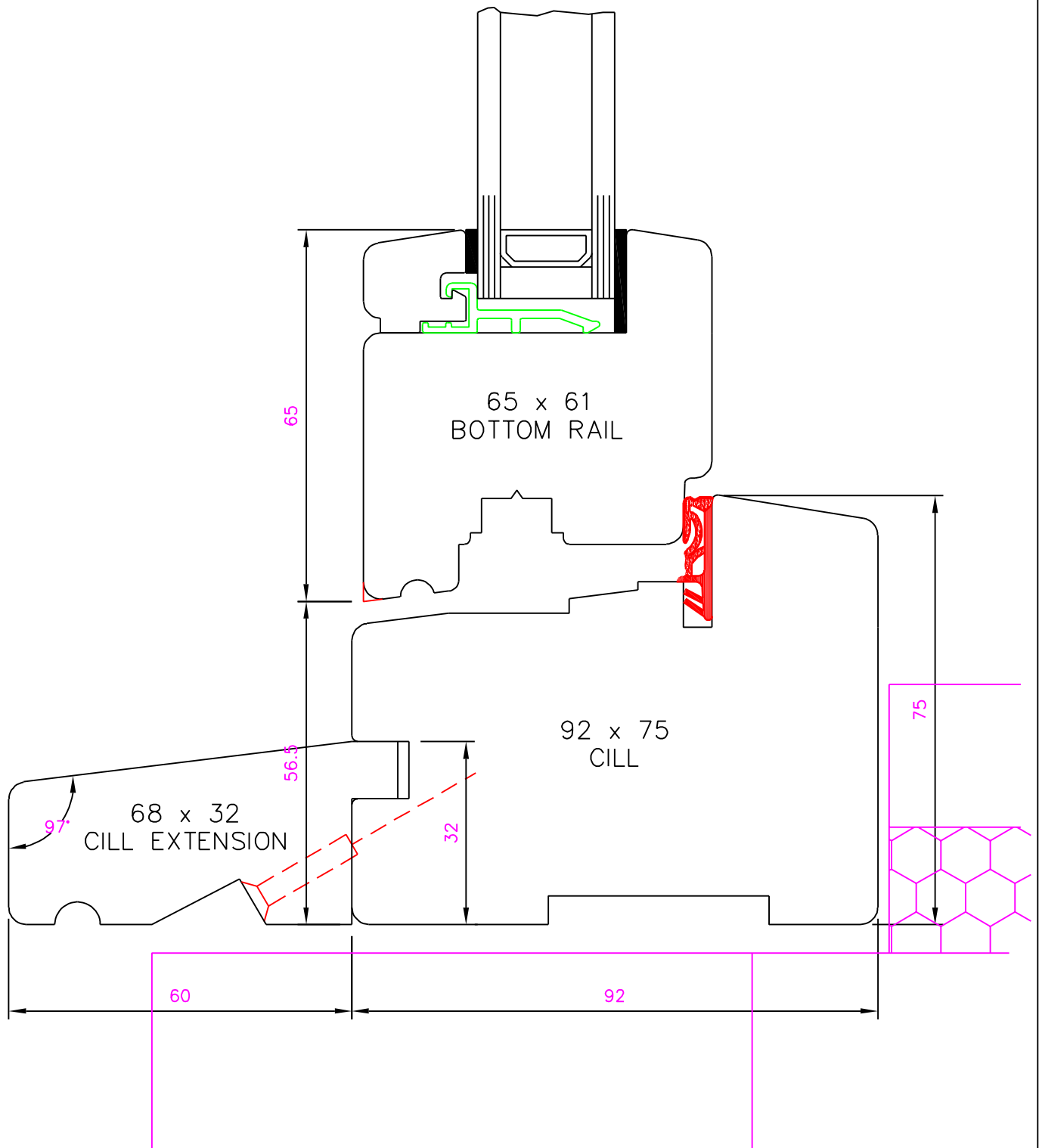

CUSTOMER: MR R EVANS, LEES HILL, SOUTH WARNBOROUGH RG29 1RQ

DRAWING TITLE: DETAIL OF CHERITON WINDOW CILL

DATE: 18.09.23

DRAWING NUMBER: D9862F.1.1

DRAWN BY: RS

SCALE: 1:1 @ A4

REVISION: -

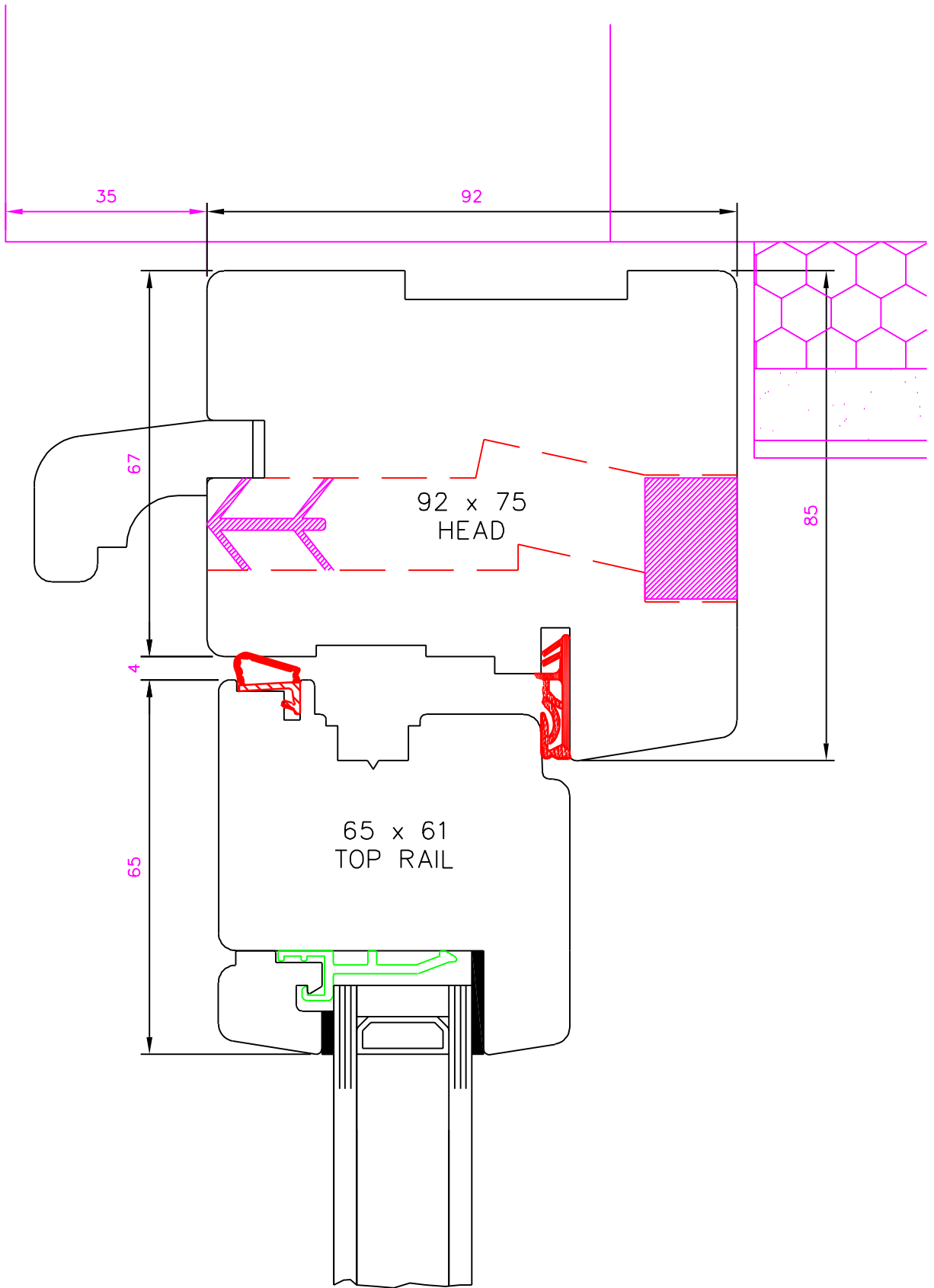

CUSTOMER: MR R EVANS, LEES HILL, SOUTH WARNBOROUGH RG29 1RQ

DRAWING TITLE: DETAIL OF CHERITON WINDOW HEAD

DATE: 18.09.23

DRAWING NUMBER: D9862F.1.2

DRAWN BY: RS

SCALE: 1:1 @ A4

REVISION: -

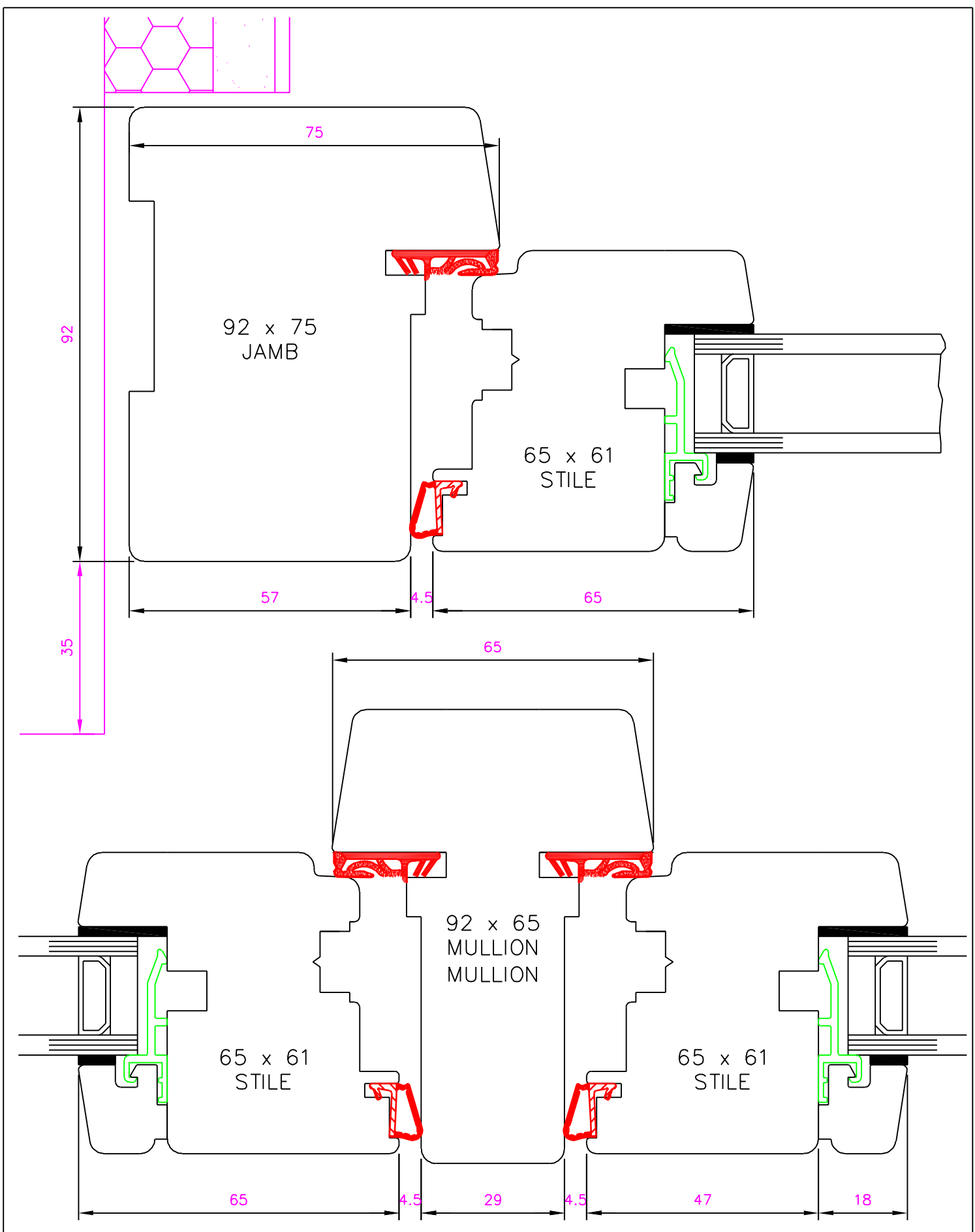

CUSTOMER: MR R EVANS, LEES HILL, SOUTH WARNBOROUGH RG29 1RQ			
DRAWING TITLE: DETAIL OF CHERITON WINDOW JAMB/MULLION			DATE: 18.09.23
DRAWING NUMBER: D9862F.1.3	DRAWN BY: RS	SCALE: 1:1 @ A4	REVISION: -

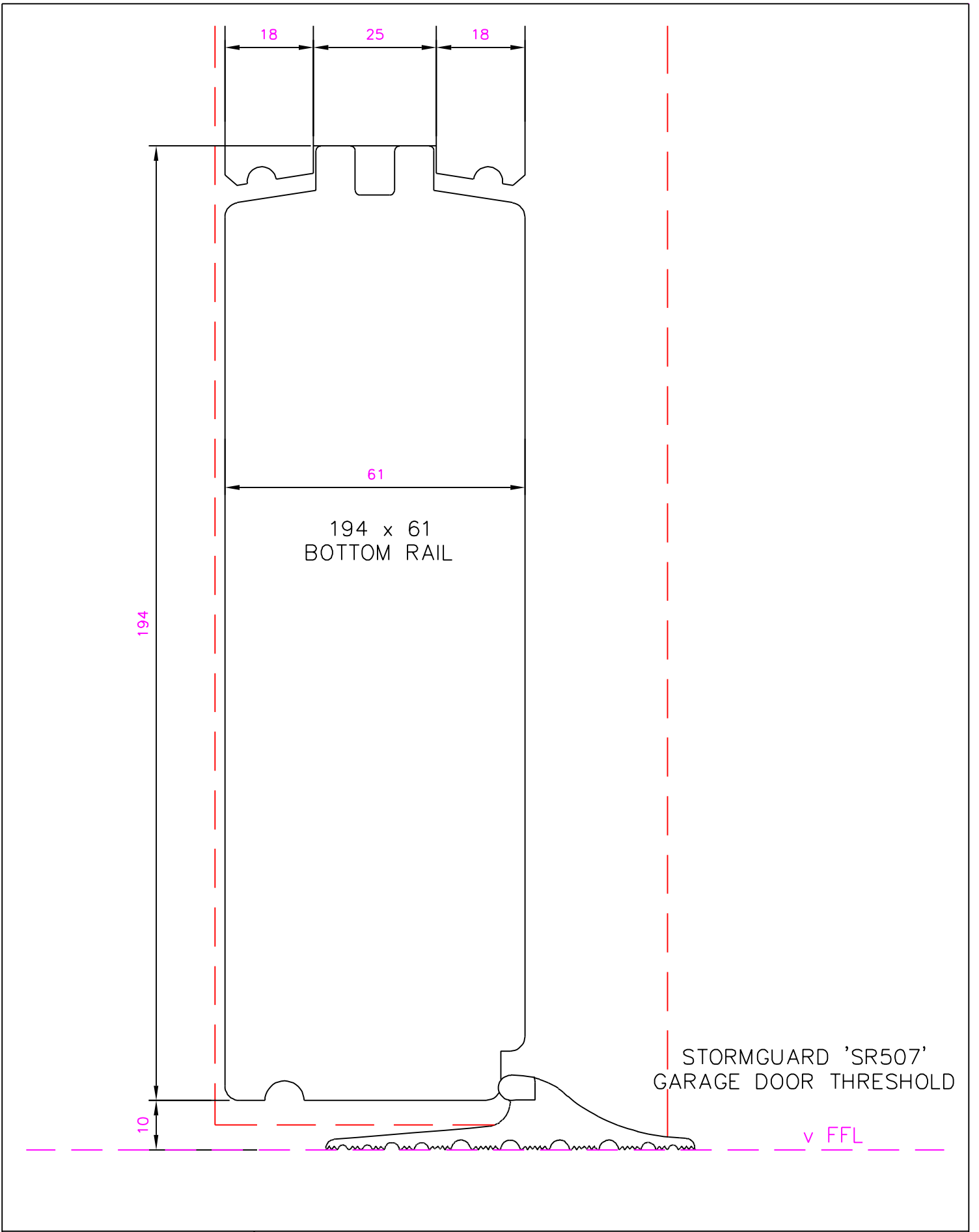

CUSTOMER: MR R EVANS, LEES HILL, SOUTH WARNBOROUGH RG29 1RQ

DRAWING TITLE: DETAIL OF O/OUT TGV THRESHOLD c/w ROLL OVER STRIP

DATE: 25.09.23

DRAWING NUMBER: D9862F.4.1

DRAWN BY: RS

SCALE: 1:1 @ A4

REVISION: -

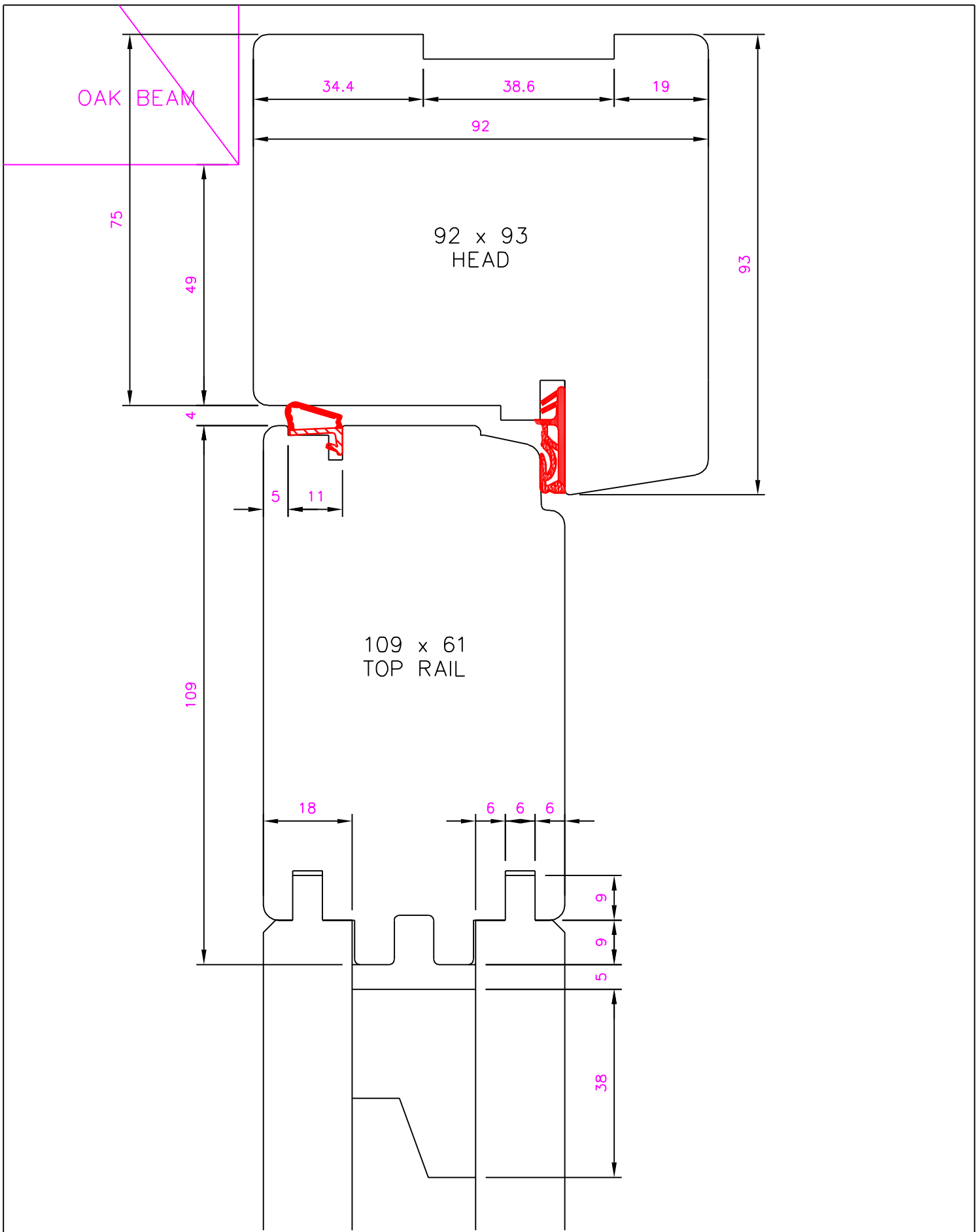

 <b>INPUT JOINERY</b>	CUSTOMER: MR R EVANS, LEES HILL, SOUTH WARNBOROUGH RG29 1RQ		
	DRAWING TITLE: DETAIL OF OPEN OUTWARD TGV BOARDED DOOR HEAD		DATE: 25.09.23
	DRAWING NUMBER: D9862F.4.2	DRAWN BY: RS	SCALE: 1:1 @ A4
			REVISION: -

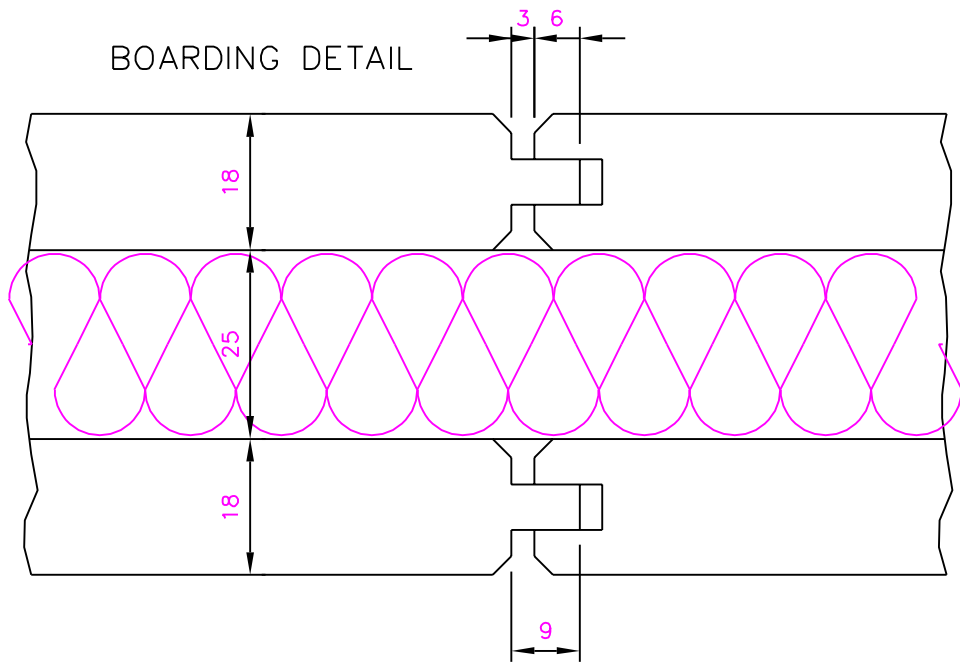
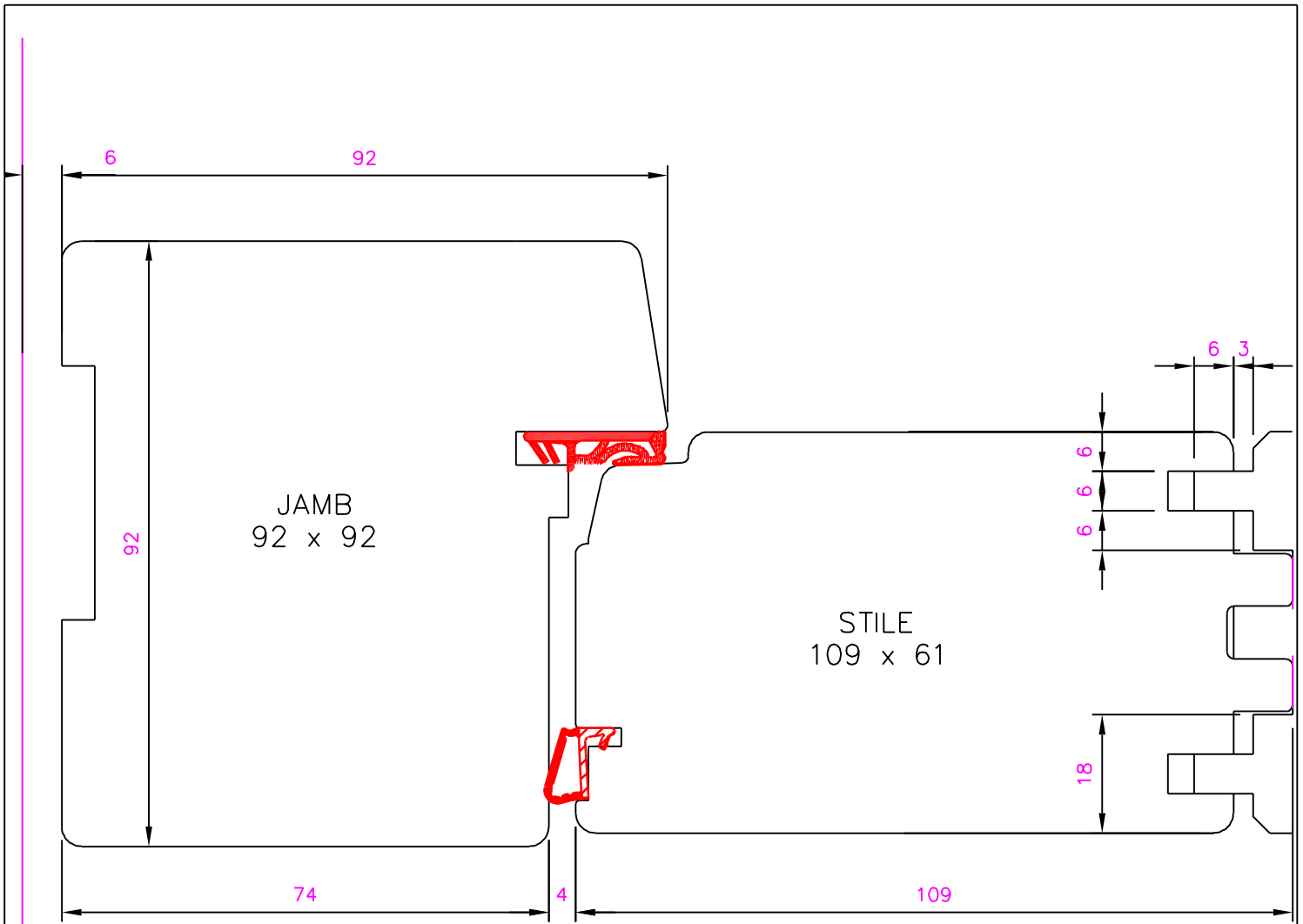

CUSTOMER: MR R EVANS, LEES HILL, SOUTH WARNBOROUGH RG29 1RQ			
DRAWING TITLE: DETAIL OF OPEN OUTWARD TGV BOARDED DOOR JAMB			DATE: 25.09.23
DRAWING NUMBER: D9862F.4.3	DRAWN BY: RS	SCALE: 1:1 @ A4	REVISION: -



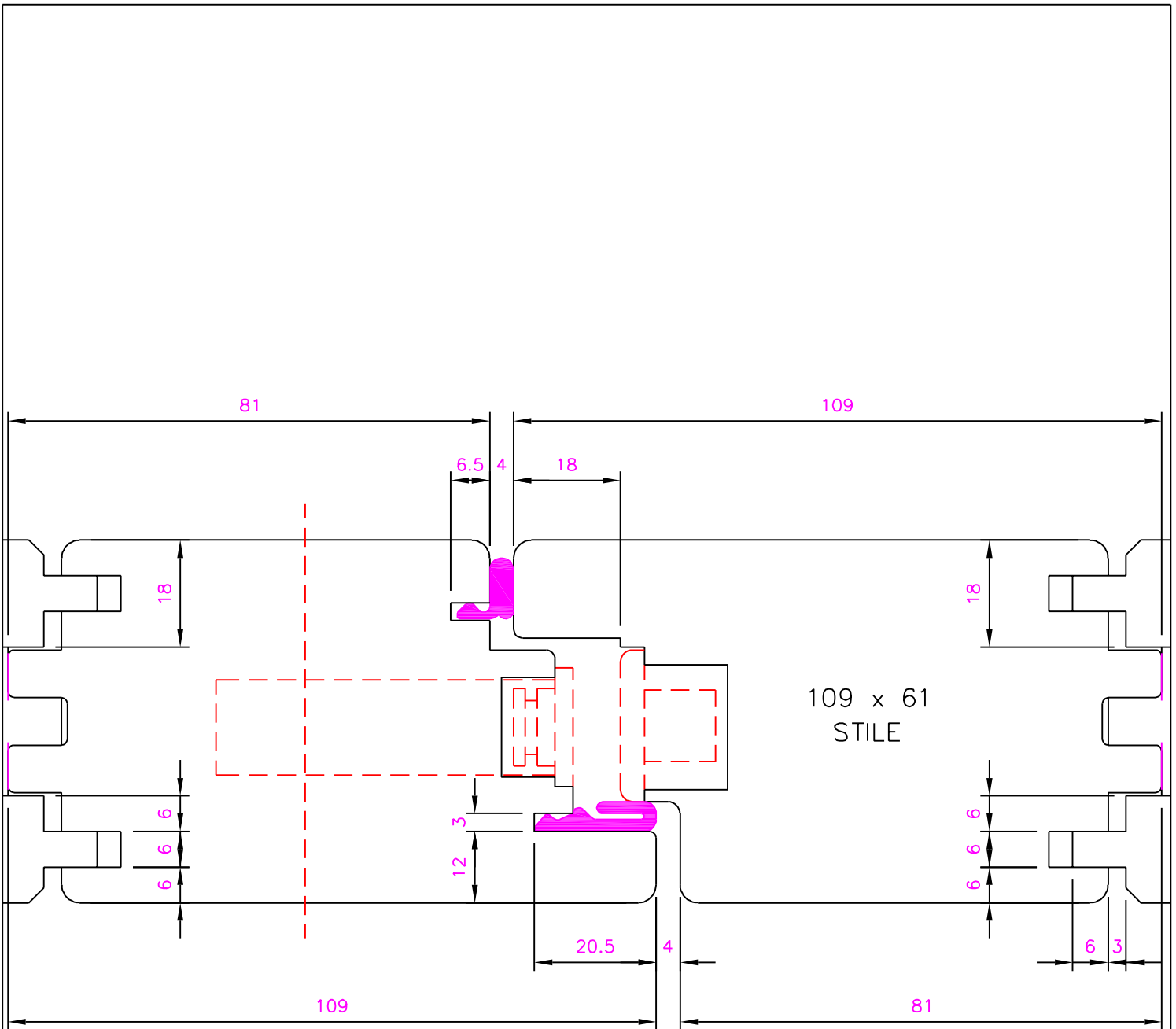

CUSTOMER: MR R EVANS, LEES HILL, SOUTH WARNBOROUGH RG29 1RQ			
DRAWING TITLE: DETAIL OF O/OUT TGV BOARDED DOOR MEETING STILES			DATE: 25.09.23
DRAWING NUMBER: D9862F.4.4	DRAWN BY: RS	SCALE: 1:1 @ A4	REVISION: -

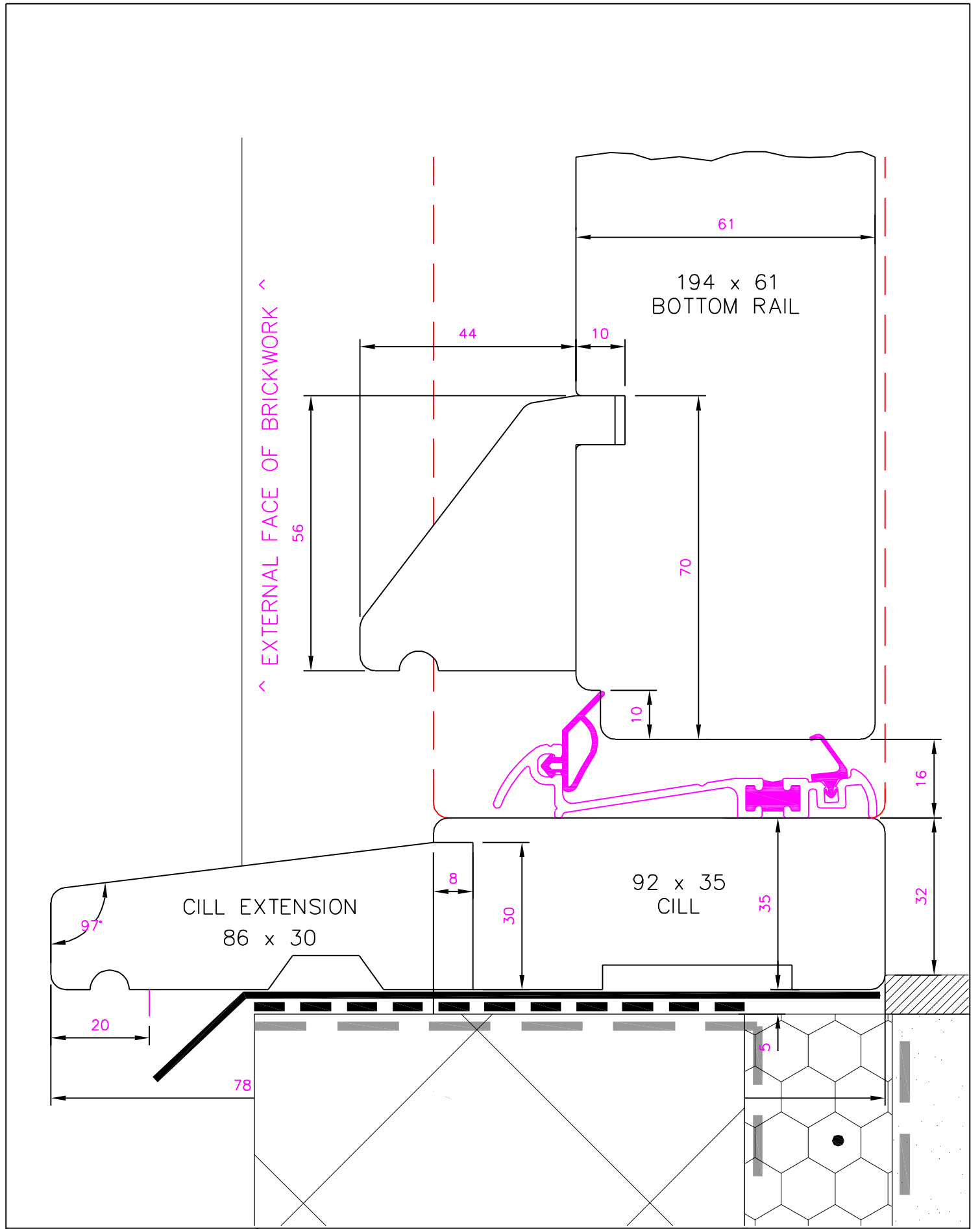

CUSTOMER: MR R EVANS, LEES HILL, SOUTH WARNBOROUGH RG29 1RQ			
DRAWING TITLE: DETAIL OF OPEN INWARD THRESHOLD (58MM SETBACK)			DATE: 31.10.23
DRAWING NUMBER: D9862F.5.1	DRAWN BY: RS	SCALE: 1:1 @ A4	REVISION: 2

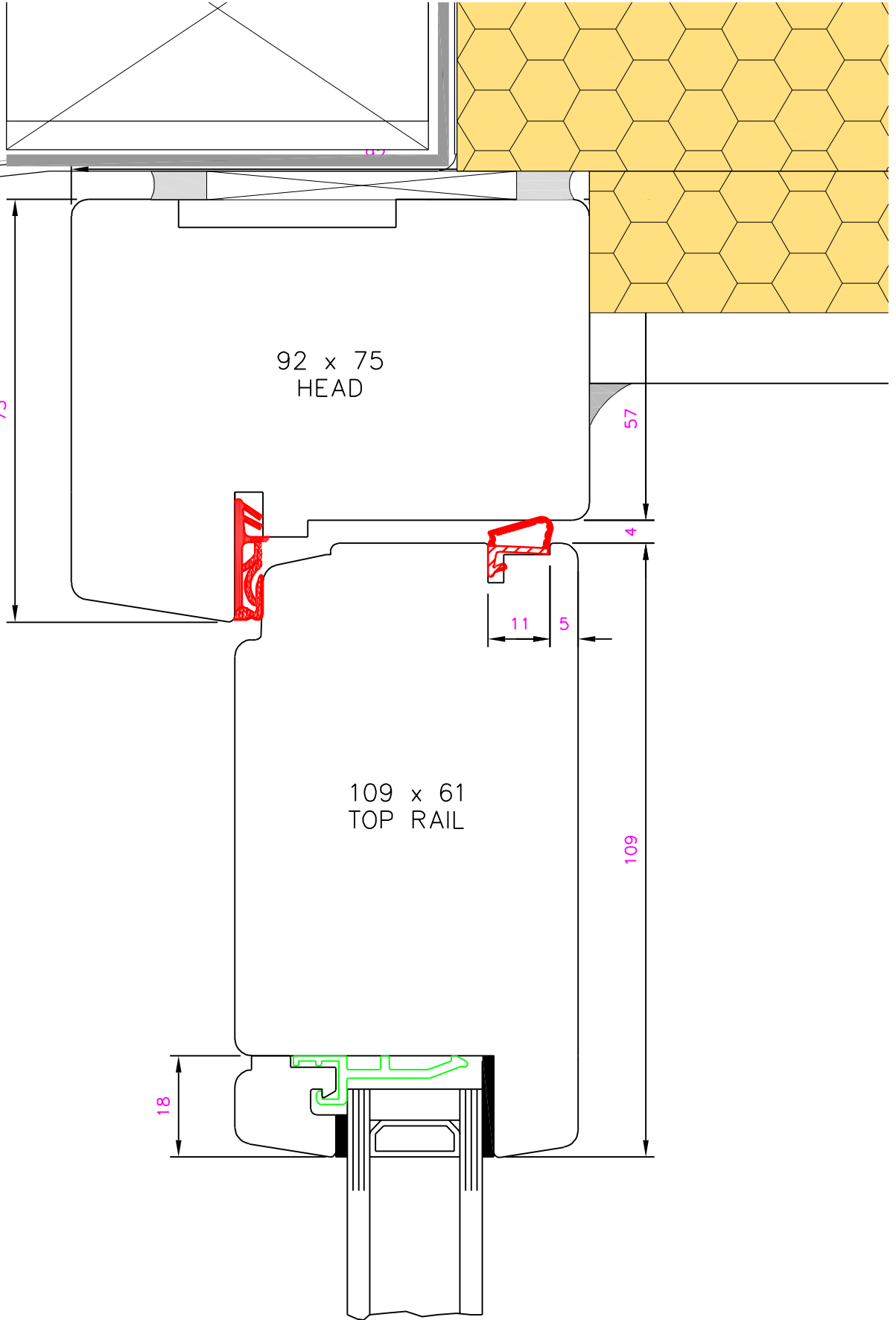
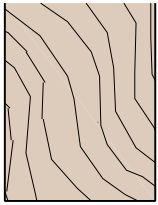

CUSTOMER: MR R EVANS, LEES HILL, SOUTH WARNBOROUGH RG29 1RQ

DRAWING TITLE: DETAIL OF OPEN INWARD HEAD @ SIDELIGHT

DATE: 03.10.23

DRAWING NUMBER: D9862F.5.2

DRAWN BY: RS

SCALE: 1:1 @ A4

REVISION: 1

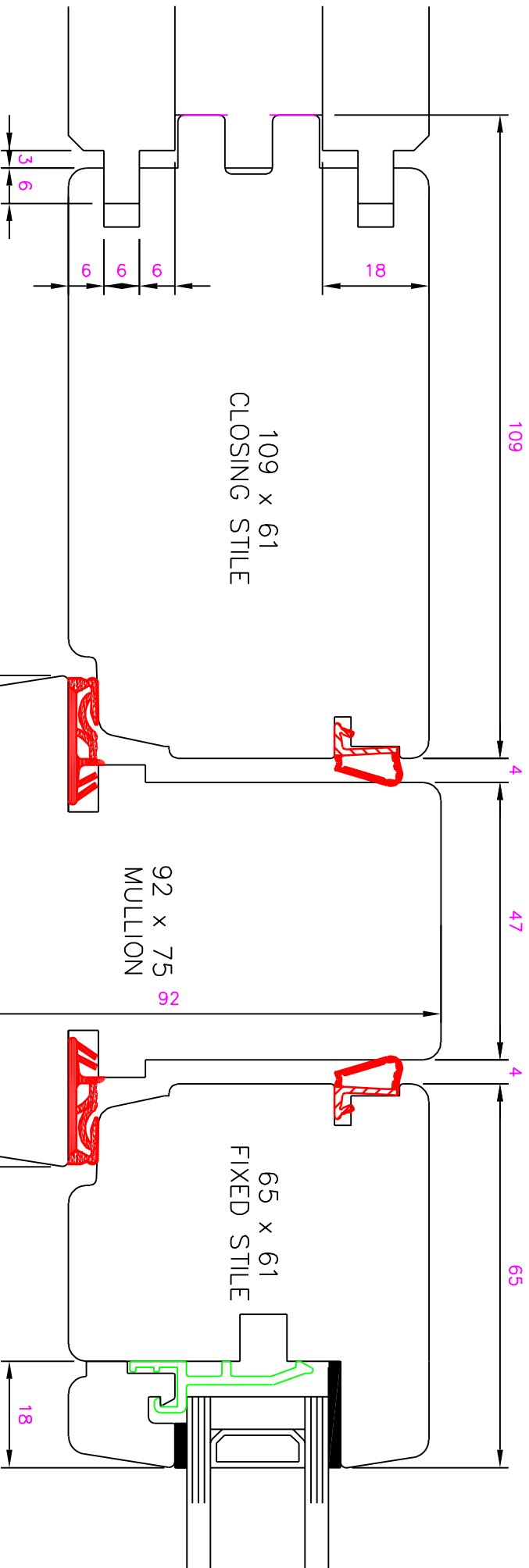

CUSTOMER: MR R EVANS, LEES HILL, SOUTH WARNBOROUGH RG29 1RQ

DRAWING TITLE: DETAIL OF OPEN INWARD MULLION

DATE: 25.09.23

DRAWING NUMBER: D9862F.5.3

DRAWN BY: RS

SCALE: 1:1 @ A4

REVISION: -

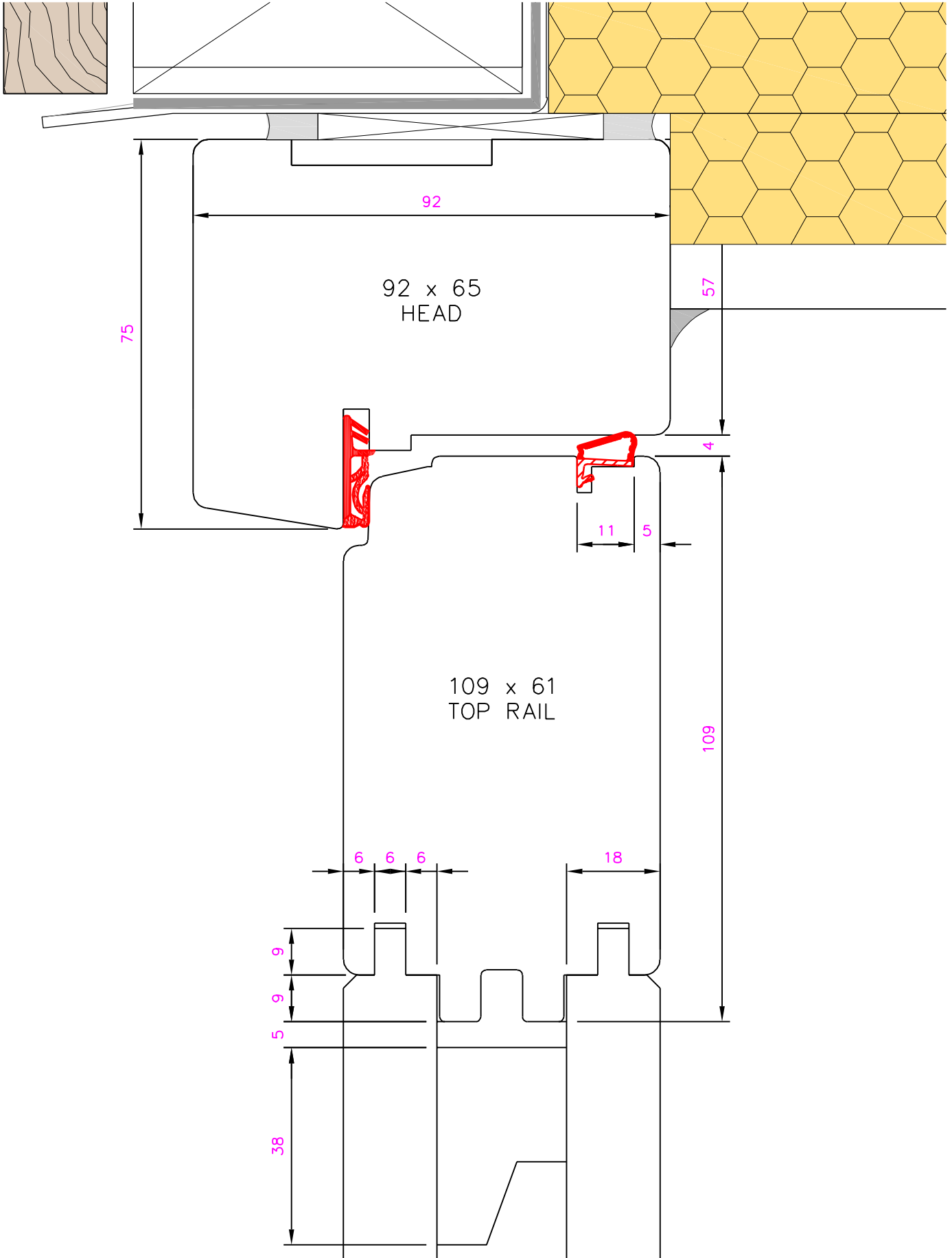

CUSTOMER: MR R EVANS, LEES HILL, SOUTH WARNBOROUGH RG29 1RQ

DRAWING TITLE: DETAIL OF OPEN INWARD HEAD @ OPENING LEAF

DATE: 03.10.23

DRAWING NUMBER: D9862F.5.4

DRAWN BY: RS

SCALE: 1:1 @ A4

REVISION: 1

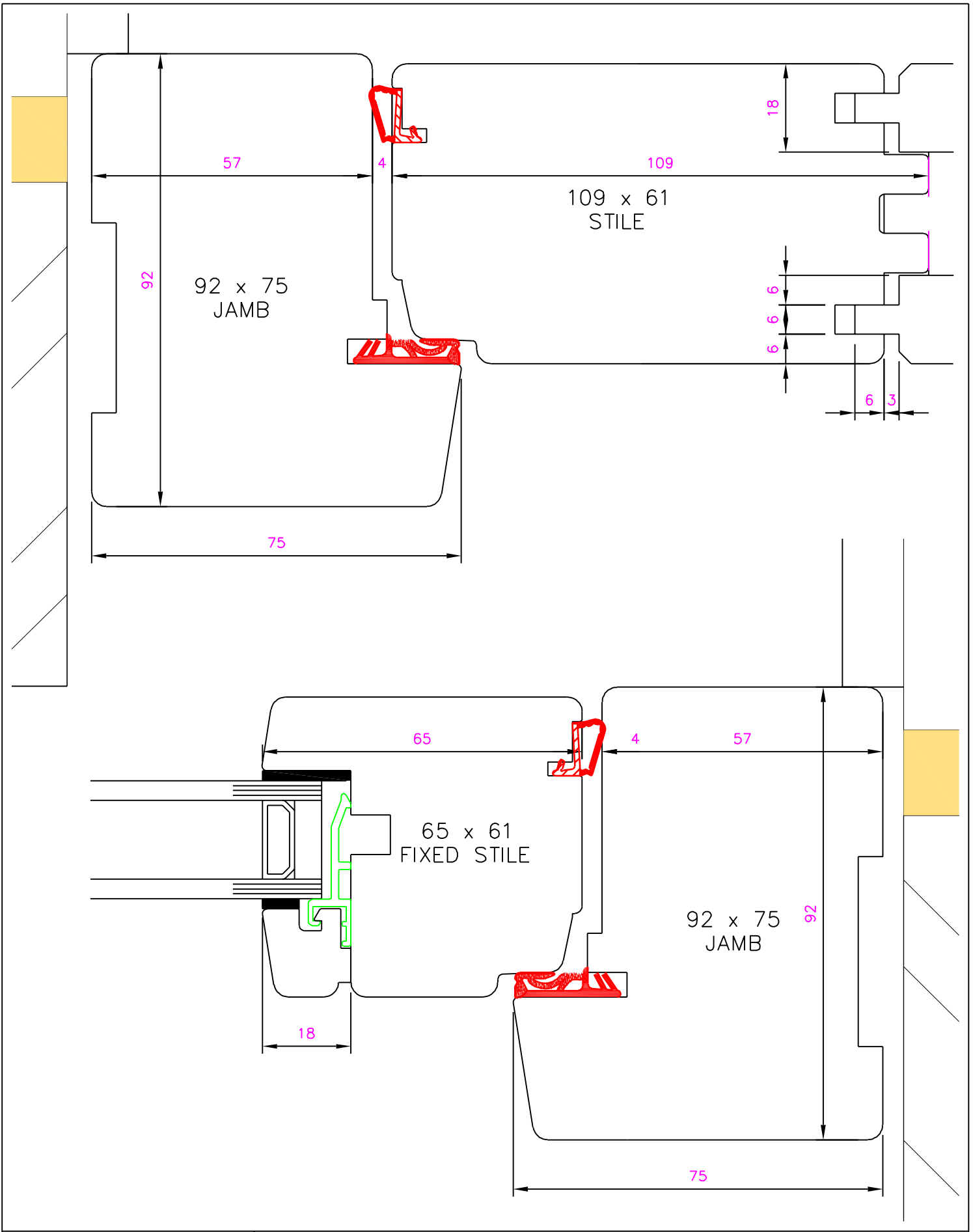

CUSTOMER: MR R EVANS, LEES HILL, SOUTH WARNBOROUGH RG29 1RQ			
DRAWING TITLE: DETAIL OF OPEN INWARD JAMBS			DATE: 03.10.23
DRAWING NUMBER: D9862F.5.5	DRAWN BY: RS	SCALE: 1:1 @ A4	REVISION: 1

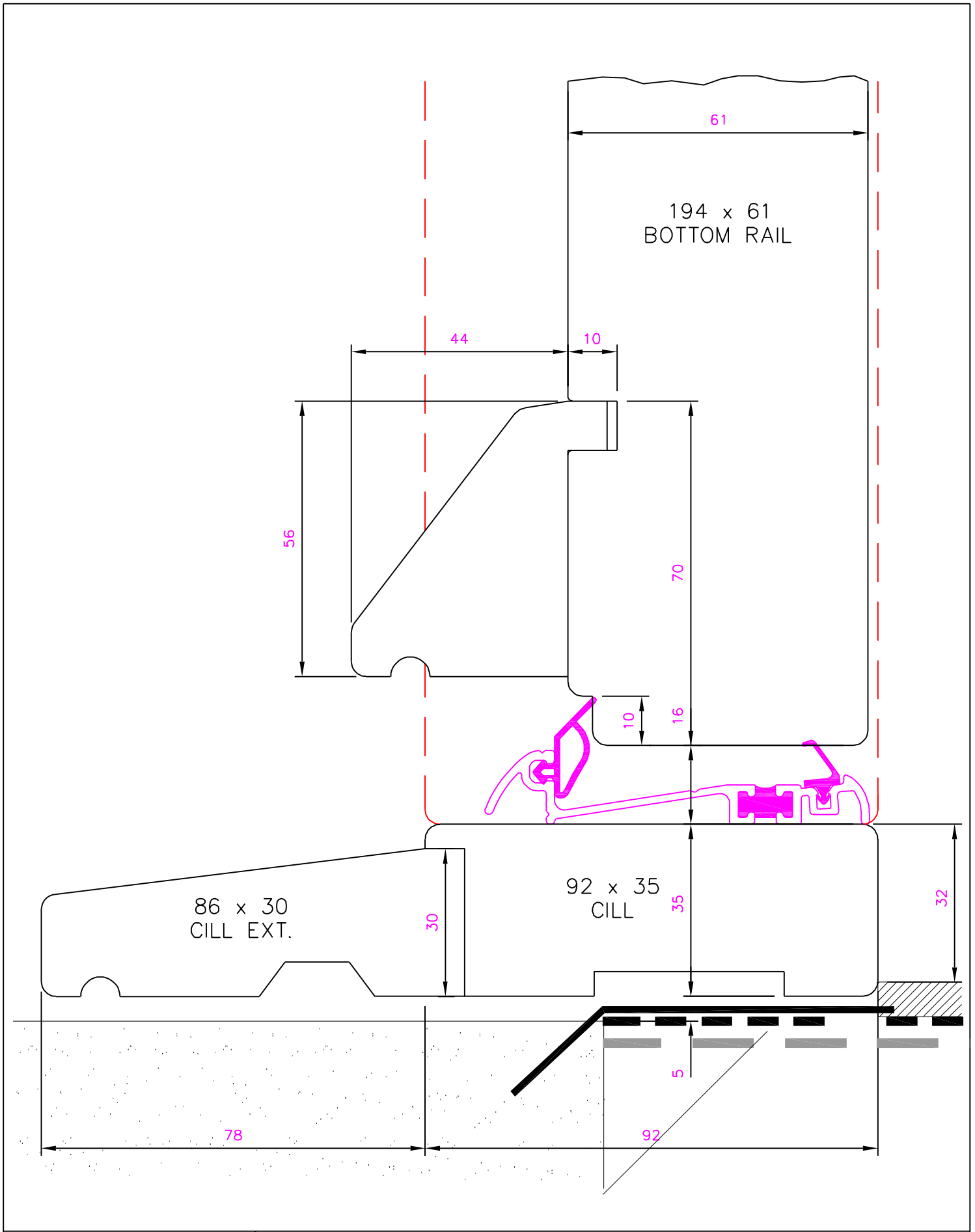

CUSTOMER: MR R EVANS, LEES HILL, SOUTH WARNBOROUGH RG29 1RQ

DRAWING TITLE: DETAIL OF OPEN INWARD THRESHOLD (78MM SETBACK)

DATE: 31.10.23

DRAWING NUMBER: D9862F.6.1

DRAWN BY: RS

SCALE: 1:1 @ A4

REVISION: 3

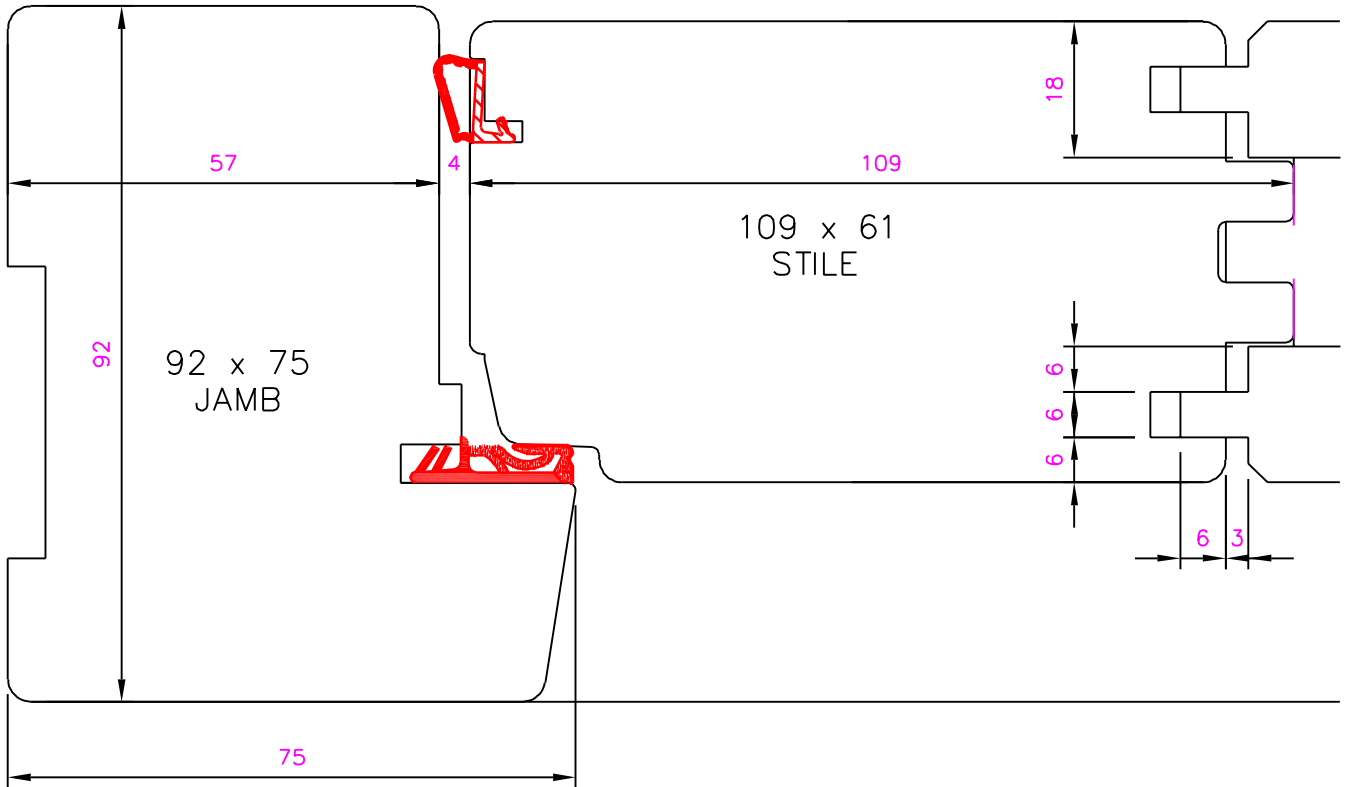

CUSTOMER: MR R EVANS, LEES HILL, SOUTH WARNBOROUGH RG29 1RQ

DRAWING TITLE: DETAIL OF OPEN INWARD JAMB @ OPENING LEAF

DATE: 26.09.23

DRAWING NUMBER: D9862F.6.3

DRAWN BY: RS

SCALE: 1:1 @ A4

REVISION: 1



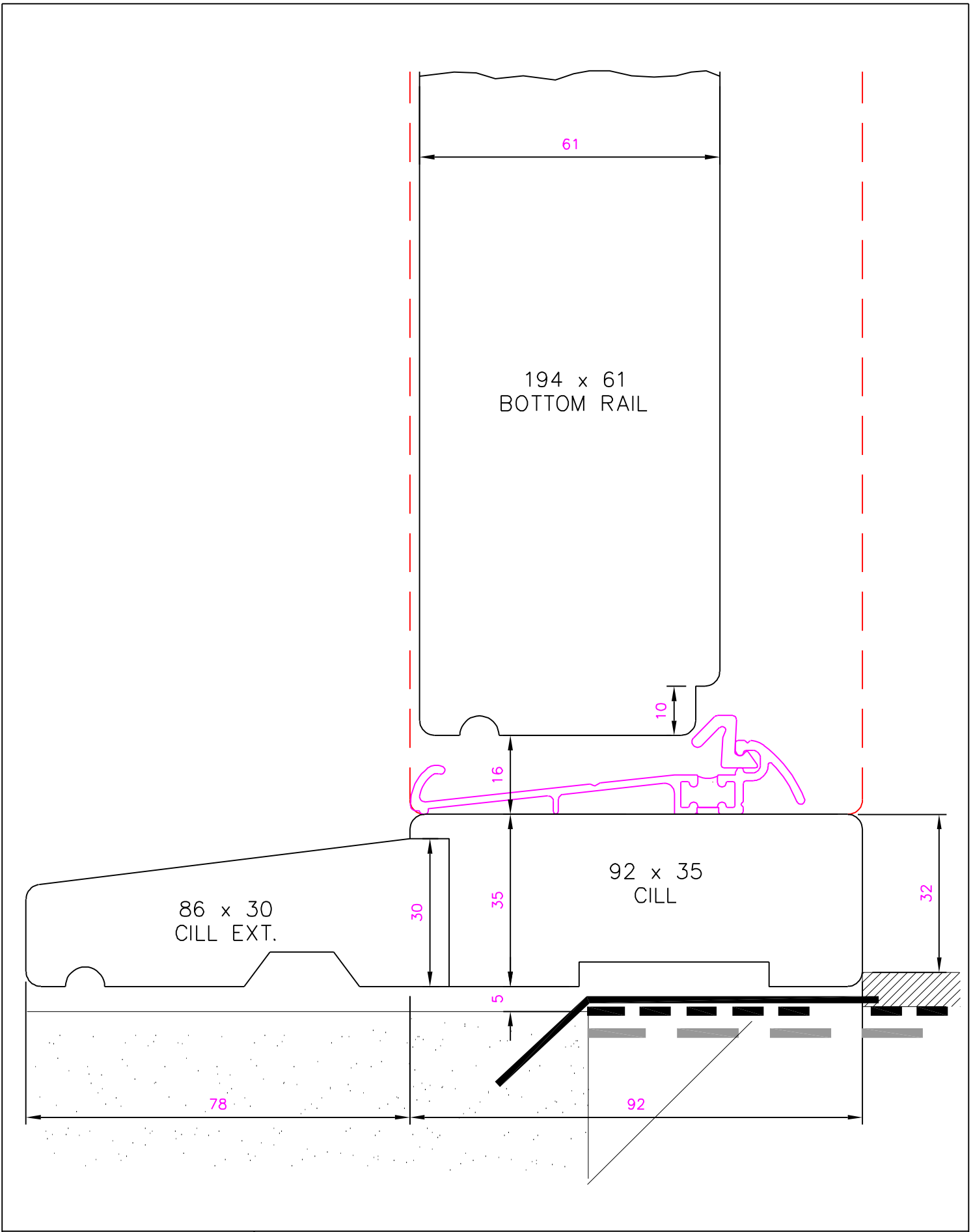

CUSTOMER: MR R EVANS, LEES HILL, SOUTH WARNBOROUGH RG29 1RQ			
DRAWING TITLE: DETAIL OF OUTWARD FACING THRESHOLD (78MM SETBACK)			DATE: 31.10.23
DRAWING NUMBER: D9862F.7.1	DRAWN BY: RS	SCALE: 1:1 @ A4	REVISION: 3

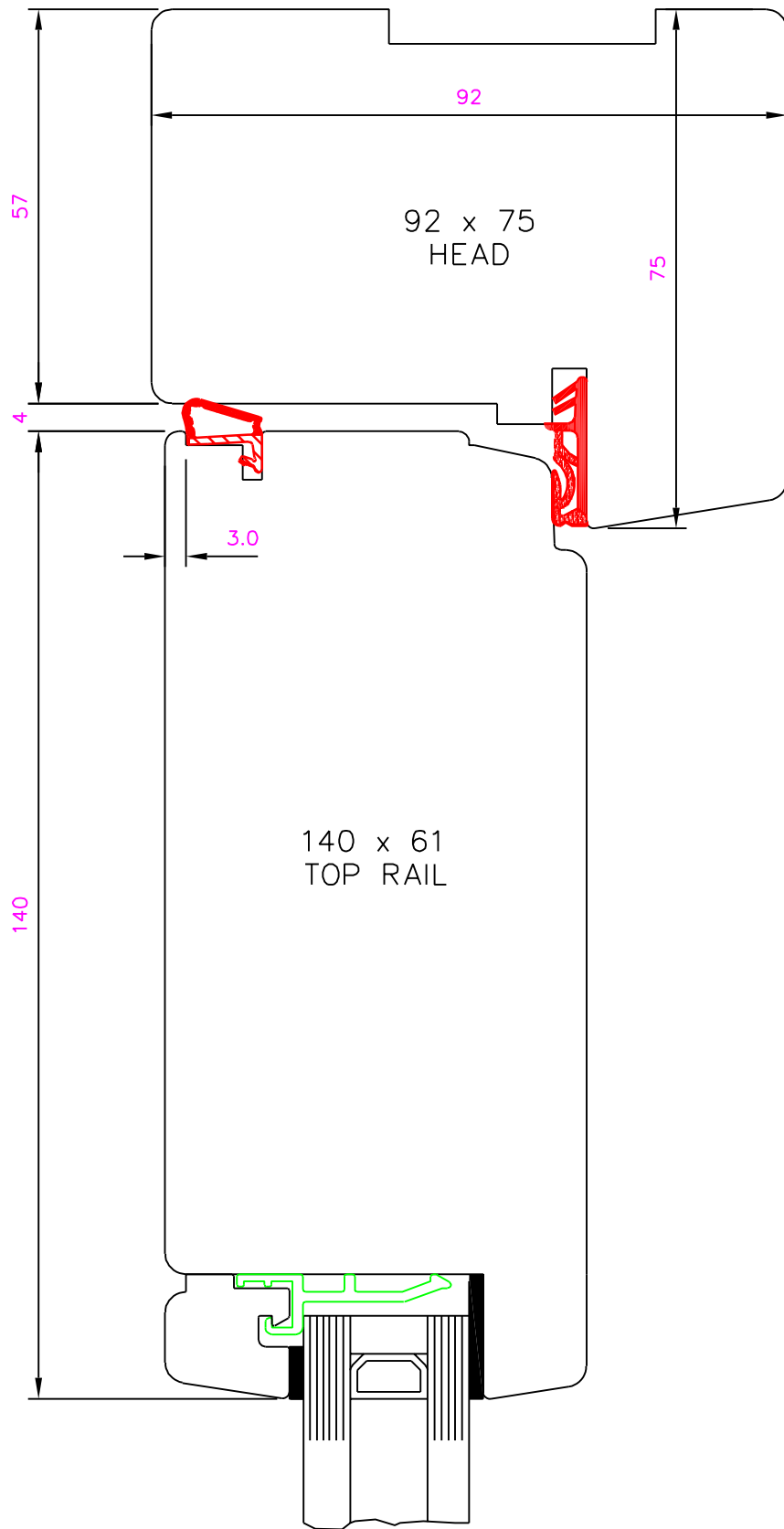

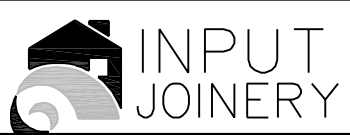
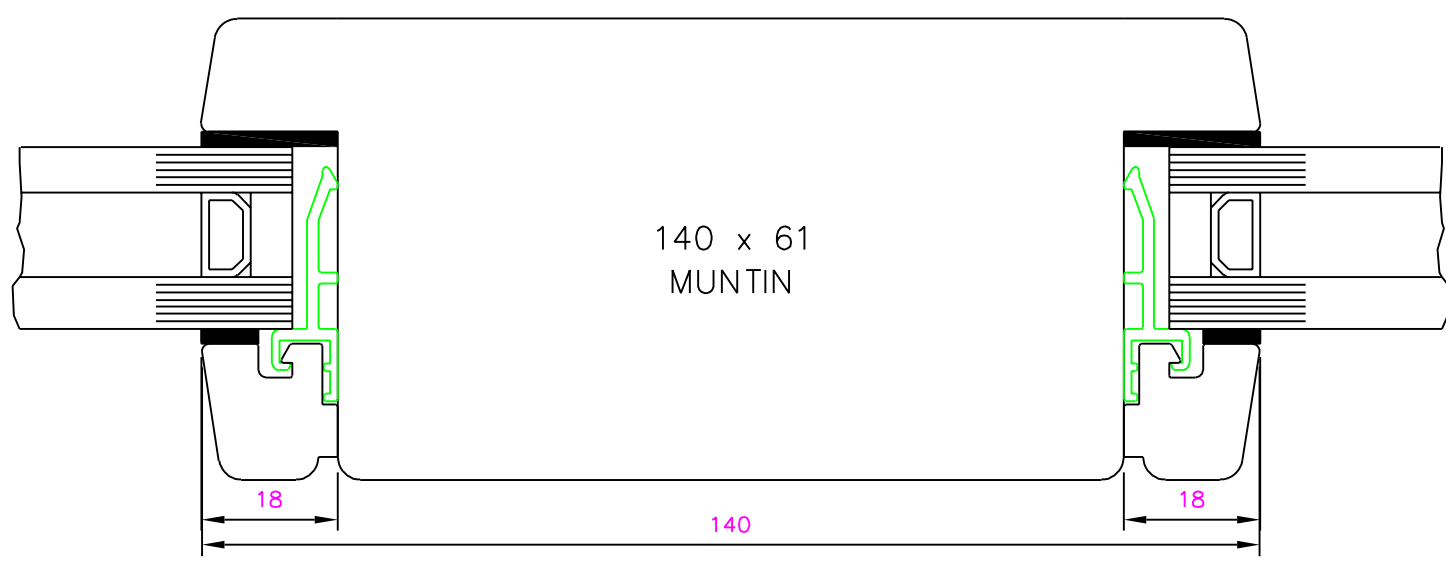
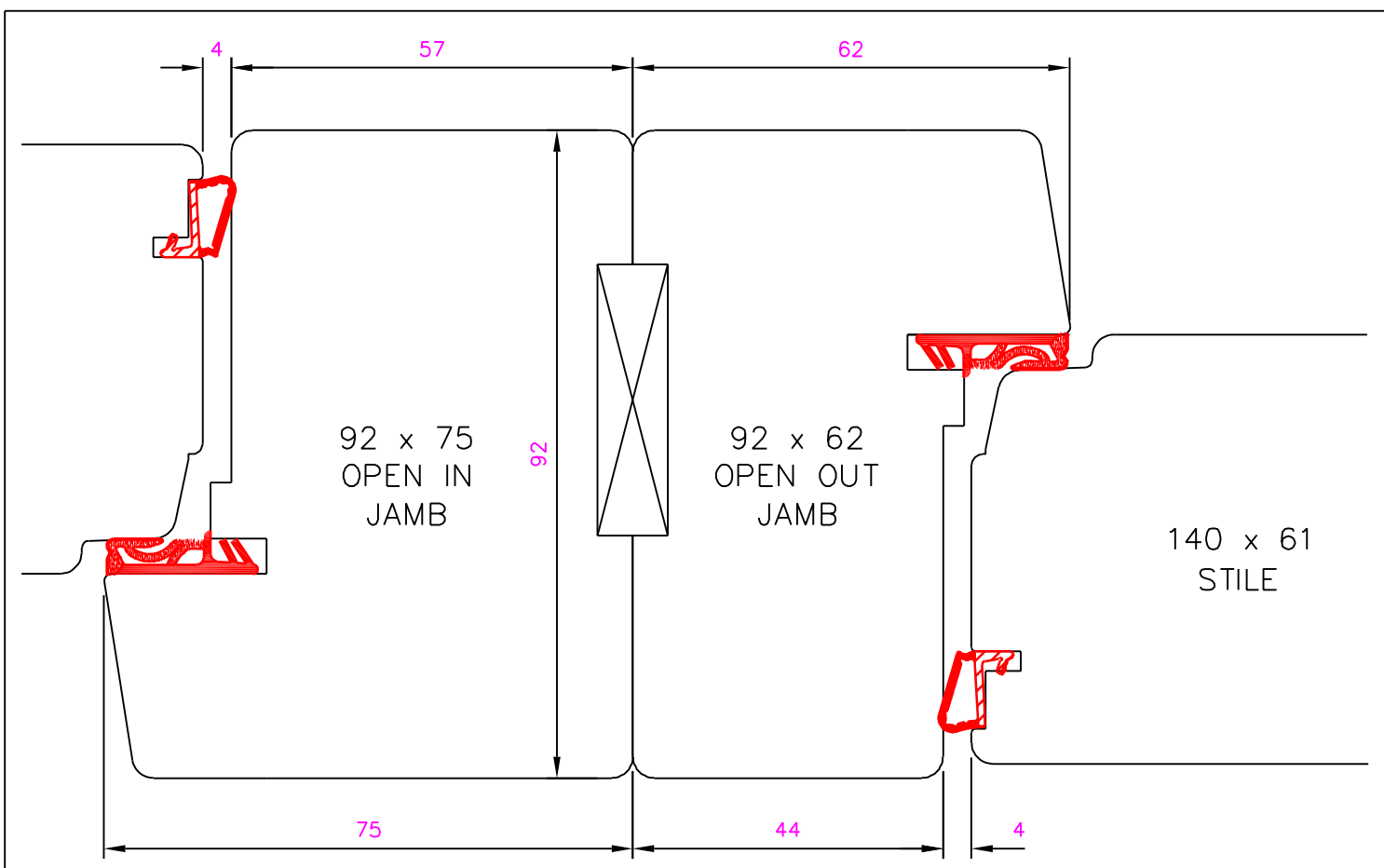

CUSTOMER: MR R EVANS, LEES HILL, SOUTH WARNBOROUGH RG29 1RQ			
DRAWING TITLE: DETAIL OF COUPLED JAMB & FIXED DOOR MUNTIN			DATE: 26.09.23
DRAWING NUMBER: D9862F.6.2	DRAWN BY: RS	SCALE: 1:1 @ A4	REVISION: 1