

**PVC SLIDING SASH WINDOWS  
VERTICAL SLIDING SASH  
SILL SECTION**

This detail relates to all windows  
apart from RG7 and RG9

 <b>BOULTER MOSSMAN</b> PROPERTY & CONSTRUCTION CONSULTANTS	PROJECT NO.	DRAWING NO.	REVISION	DRAWN	CHECKED	DATE	SCALE
	5495	16 Sill		EV	GG	AUG 23	1/2 @ A4
	PROJECT TITLE	REPLACEMENT WINDOWS AND DOORS AT 73 ROSELANDS GARDENS, SOUTHAMPTON					
CLIENT	ABRI HOUSING ASSOCIATION						

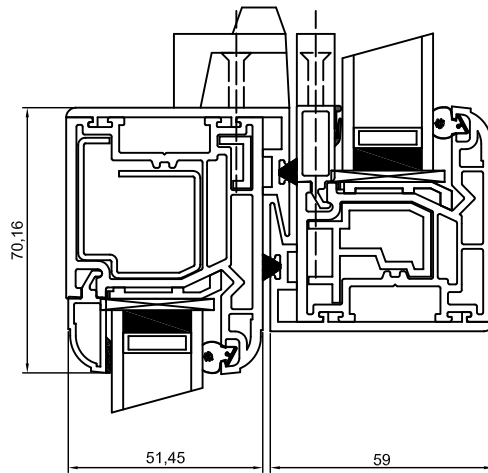

PVC SLIDING SASH WINDOWS  
 VERTICAL SLIDING SASH  
 MID-RAIL SECTION

This detail relates to all windows  
 apart from RG7 and RG9

 <b>BOULTER MOSSMAN</b> PROPERTY & CONSTRUCTION CONSULTANTS	PROJECT NO.	DRAWING NO.	REVISION	DRAWN	CHECKED	DATE	SCALE
	5495	17 Mid Rail		EV	GG	AUG 23	1/2 @ A4
	PROJECT TITLE	REPLACEMENT WINDOWS AND DOORS AT 73 ROSELANDS GARDENS, SOUTHAMPTON					
CLIENT	ABRI HOUSING ASSOCIATION						

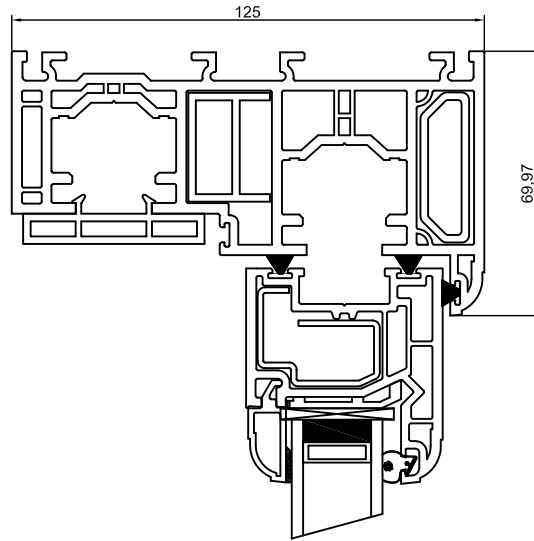

PVC SLIDING SASH WINDOWS  
 VERTICAL SLIDING SASH  
 HEAD SECTION

This detail relates to all windows  
 apart from RG7 and RG9

 <b>BOULTER MOSSMAN</b> <small>PROPERTY &amp; CONSTRUCTION CONSULTANTS</small>	PROJECT NO.	DRAWING NO.	REVISION	DRAWN	CHECKED	DATE	SCALE
	5495	18 Head		EV	GG	AUG 23	1/2 @ A4
	PROJECT TITLE	REPLACEMENT WINDOWS AND DOORS AT 73 ROSELANDS GARDENS, SOUTHAMPTON					
CLIENT	ABRI HOUSING ASSOCIATION						

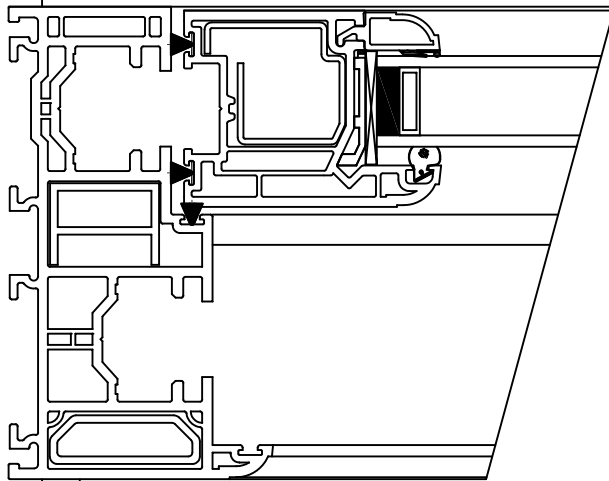

PVC SLIDING SASH WINDOWS  
 VERTICAL SLIDING SASH  
 JAMB SECTION

This detail relates to all windows  
 apart from RG7 and RG9

 <b>BOULTER MOSSMAN</b> <small>PROPERTY &amp; CONSTRUCTION CONSULTANTS</small>	PROJECT NO.	DRAWING NO.	REVISION	DRAWN	CHECKED	DATE	SCALE
	5495	19 Jamb		EV	GG	AUG 23	1/2 @ A4
	PROJECT TITLE	REPLACEMENT WINDOWS AND DOORS AT 73 ROSELANDS GARDENS, SOUTHAMPTON					
CLIENT	ABRI HOUSING ASSOCIATION						

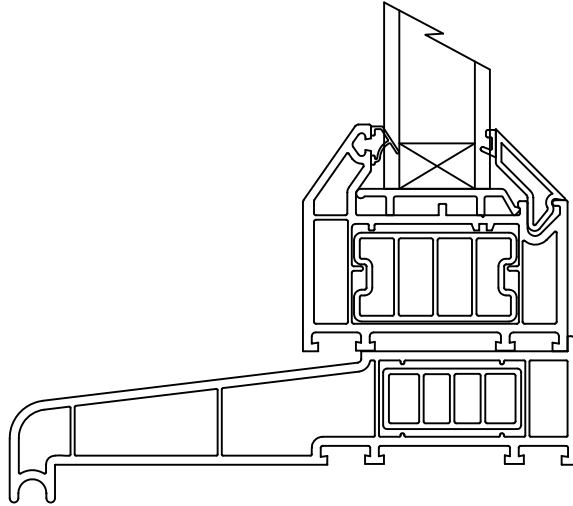

**TYPICAL PVC  
CASEMENT WINDOW  
SILL SECTION**

This detail relates windows  
RG7 and RG9

 <b>BOULTER MOSSMAN</b> PROPERTY & CONSTRUCTION CONSULTANTS	PROJECT NO.	DRAWING NO.	REVISION	DRAWN	CHECKED	DATE	SCALE
	5495	20 Sill		EV	GG	AUG 23	1/2 @ A4
	PROJECT TITLE	REPLACEMENT WINDOWS AND DOORS AT 73 ROSELANDS GARDENS, SOUTHAMPTON					
CLIENT	ABRI HOUSING ASSOCIATION						

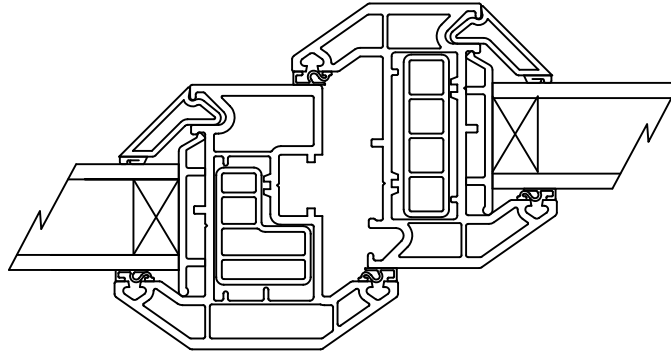

**TYPICAL PVC  
 OPENING CASEMENT WINDOW  
 MULLION SECTION**

This detail relates windows  
 RG7 and RG9

 <b>BOULTER MOSSMAN</b> <small>PROPERTY &amp; CONSTRUCTION CONSULTANTS</small>	PROJECT NO.	DRAWING NO.	REVISION	DRAWN	CHECKED	DATE	SCALE
	5495	10 Mullion		EV	GG	AUG 23	1/2 @ A4
	PROJECT TITLE	REPLACEMENT WINDOWS AND DOORS AT 73 ROSELANDS GARDENS, SOUTHAMPTON					
CLIENT	ABRI HOUSING ASSOCIATION						

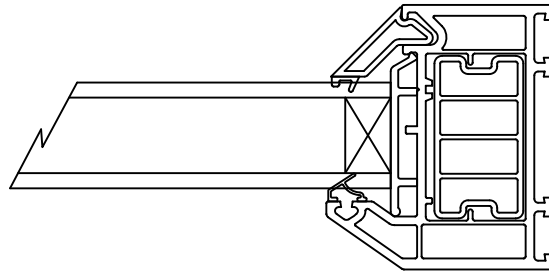

TYPICAL PVC  
CASEMENT WINDOW  
JAMB

This detail relates windows  
RG7 and RG9

 <b>BOULTER MOSSMAN</b> PROPERTY & CONSTRUCTION CONSULTANTS	PROJECT NO.	DRAWING NO.	REVISION	DRAWN	CHECKED	DATE	SCALE
	5495	22 Jamb		EV	GG	AUG 23	1/2 @ A4
	PROJECT TITLE	REPLACEMENT WINDOWS AND DOORS AT 73 ROSELANDS GARDENS, SOUTHAMPTON					
CLIENT	ABRI HOUSING ASSOCIATION						

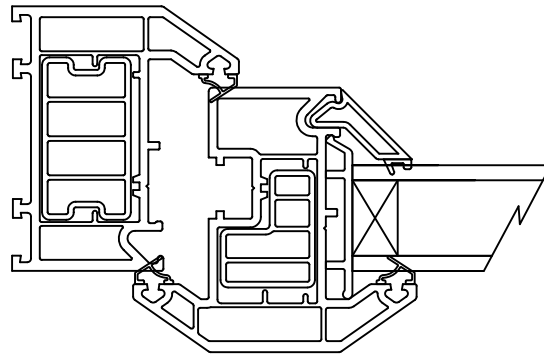

TYPICAL PVC  
CASEMENT WINDOW  
OPENING JAMB

This detail relates windows  
RG7 and RG9

 <b>BOULTER MOSSMAN</b> PROPERTY & CONSTRUCTION CONSULTANTS	PROJECT NO.	DRAWING NO.	REVISION	DRAWN	CHECKED	DATE	SCALE
	5495	23 Jamb op.		EV	GG	AUG 23	1/2 @ A4
	PROJECT TITLE	REPLACEMENT WINDOWS AND DOORS AT 73 ROSELANDS GARDENS, SOUTHAMPTON					
CLIENT	ABRI HOUSING ASSOCIATION						