



Ridings Forestry

# 2023

David Wattam BSc(Hons)For-HND-Arb RIDINGS FORESTRY UK LTD  
BS5837 2012 TREE SURVEY

## Rosemary Coote

Proposed Garden Buildings - 16 Main Street Hotham, YO43 4U, East Riding of Yorkshire.

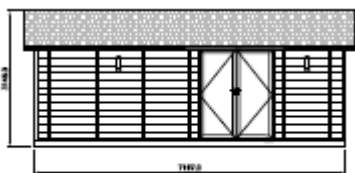

FRONT ELEVATION F-F  
SCALE 1:50



Ridings Forestry

UK LTD

Monday, October 30, 2023

## Instructions

This tree survey gives recommendations and guidance on the principles to be applied to achieve a satisfactory juxtaposition of trees, including shrubs, hedges and hedgerows when building works are proposed. It follows, in sequence, the stages of planning and implementing the provisions which are essential to allow the development to be integrated with the trees.

A tree survey is required to be carried out in accordance with BS5837:2012. The survey is to include a tree schedule for all trees that are shown on the attached drawings, an impact assessment and a method statement for protecting the trees during the construction period.

## 1) Introduction

This report provides information in accordance with recommendations given in British Standard 5837:2012 for 2 proposed Garden Buildings 16 Main Street Hotham, East Riding of Yorkshire.

## Location Plan



## 3) Date of Inspection

The trees were inspected on the 26 October 2023. Weather conditions were fine.

#### 4) Historical/Background Information

It is proposed to erect 2 Garden Buildings at 16 Main Street Hotham, East Riding of Yorkshire. The site is located within the Hotham Conservation Area.

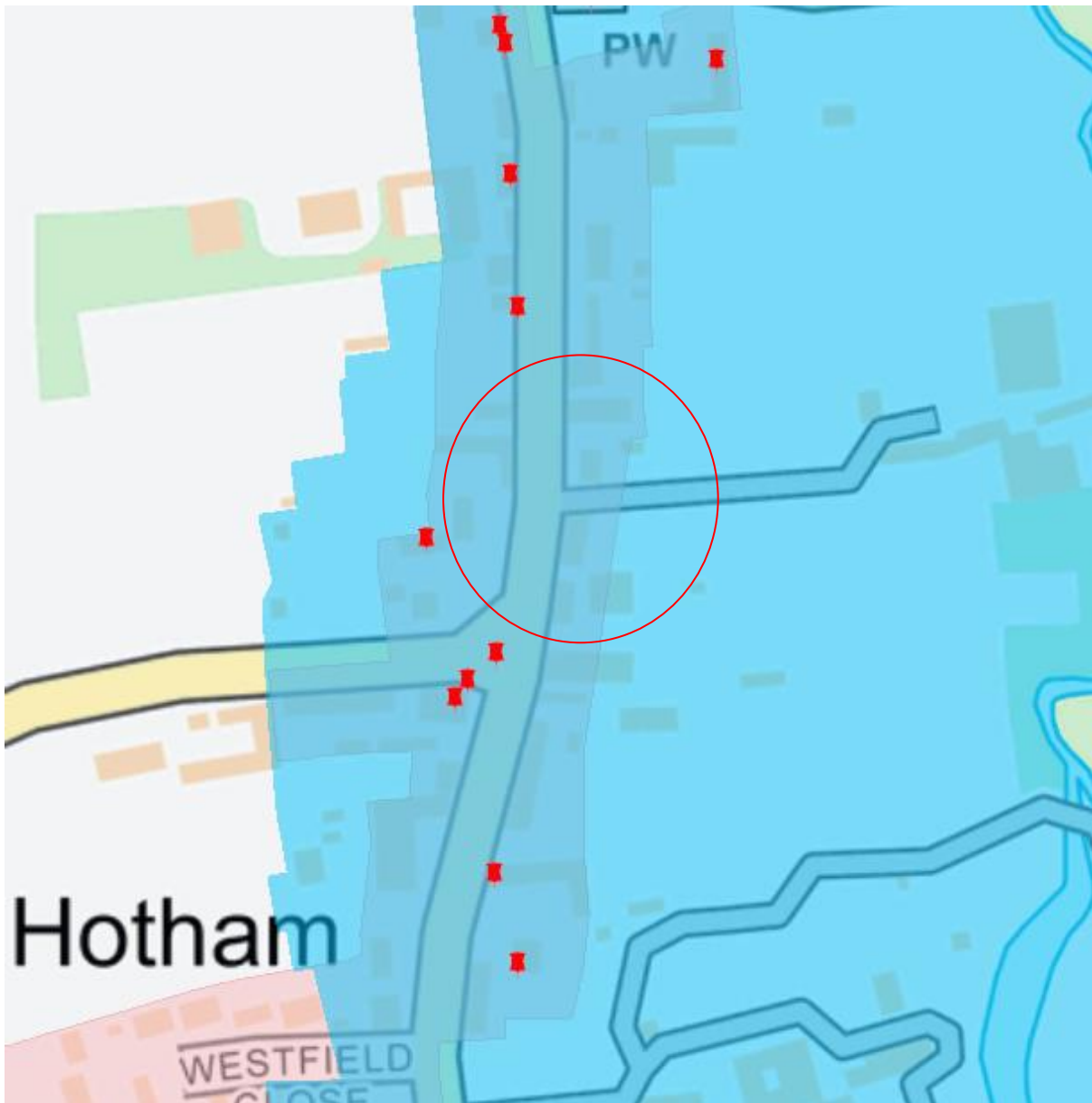

#### 5) Survey Data Collected

- Tree ref
- Species
- Height
- DBH
- Crown Spread N S E W
- Height from Ground to Crown
- Age Class
- Physical Condition
- Structural Condition
- Other Comments
- Management Recommendations
- Safe Life Expectancy

### 6) Wildlife & Countryside Act

Birds and Bats are protected by the above act. No roosts or nests were noted during the tree survey. However, should anything be noted when any works are to undertaken Natural England must be contacted.

### 7) Development Report

The locations of the trees and their grades in relation to BS 5837 2012 are shown on the plan below.

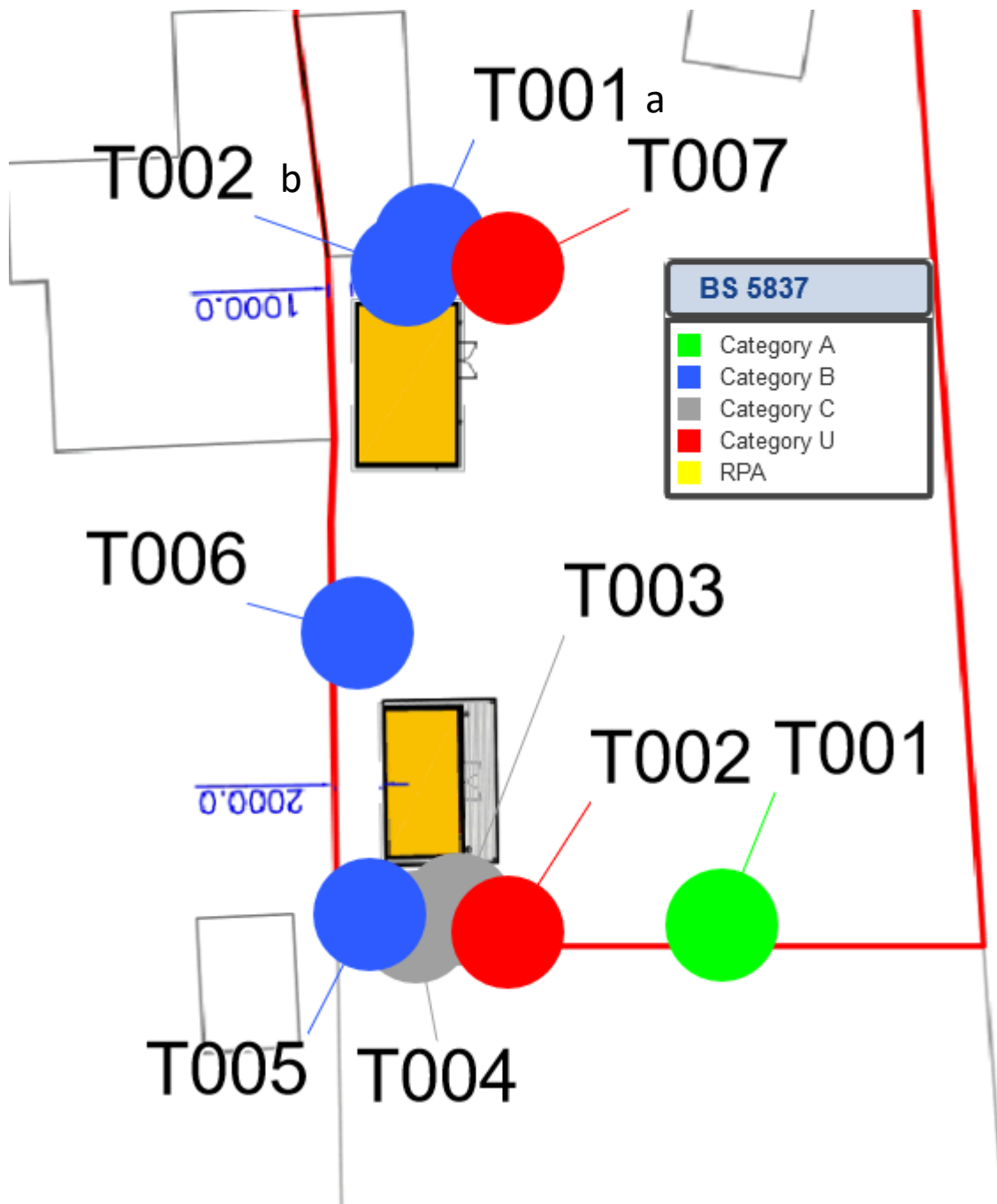

The site is located in the heart of Hotham Conservation Area. The on-site trees are located within the rear garden of the property. The trees do not form a significant part of the Hotham conservation area street scene. Please see photograph below.





T001Is a mature specimen Cherry tree and has been classed as Grade A . Please see picture below.



**T001 Cherry**



T002, T003 and T004 are trees growing in close proximity to each other. Each has suppressed the other leading to the demise of T002. Please see pictures below.



T002

T003

T004

T005 is a Cedar and has been classed as Grade B. Please see picture below.



T005 Cedar



**T001a and T002b Holly**





### 7.1.) Tree Constraints Plan

All survey data and work recommendations can be found in Appendix B of this report.

### 7.2) Root Protection Areas

Following the criteria laid out in BS5837, in my opinion there is 1 Grade A tree

#### Root Protection Areas

The root protection distances for the trees have been included in the survey schedule. Details of the fencing are given in appendix A.

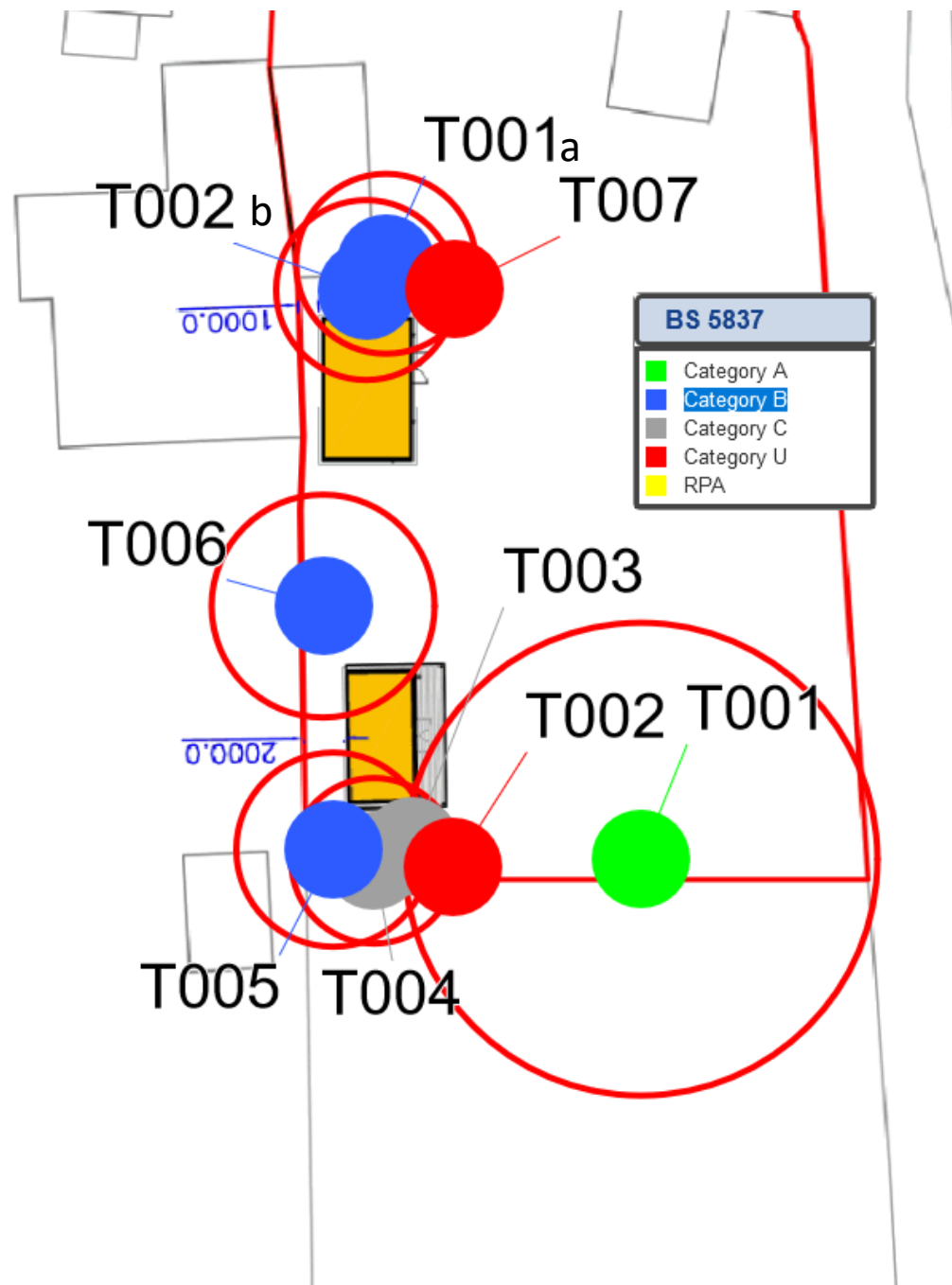

### 7.3) Tree Protection Plan

Tree Protection Fencing and Ground Protection should be erected as detailed in the plan below. See Appendix A for fencing details. Fencing should remain in place for the duration of the build.

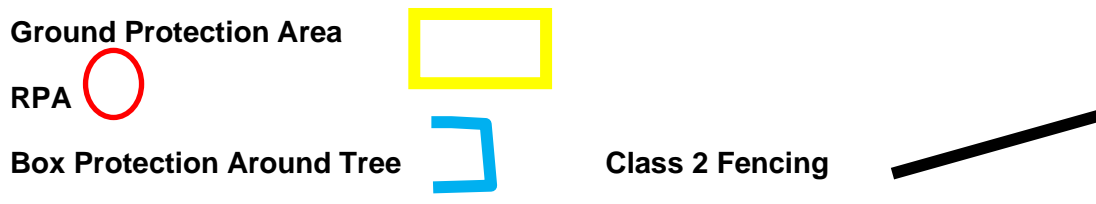
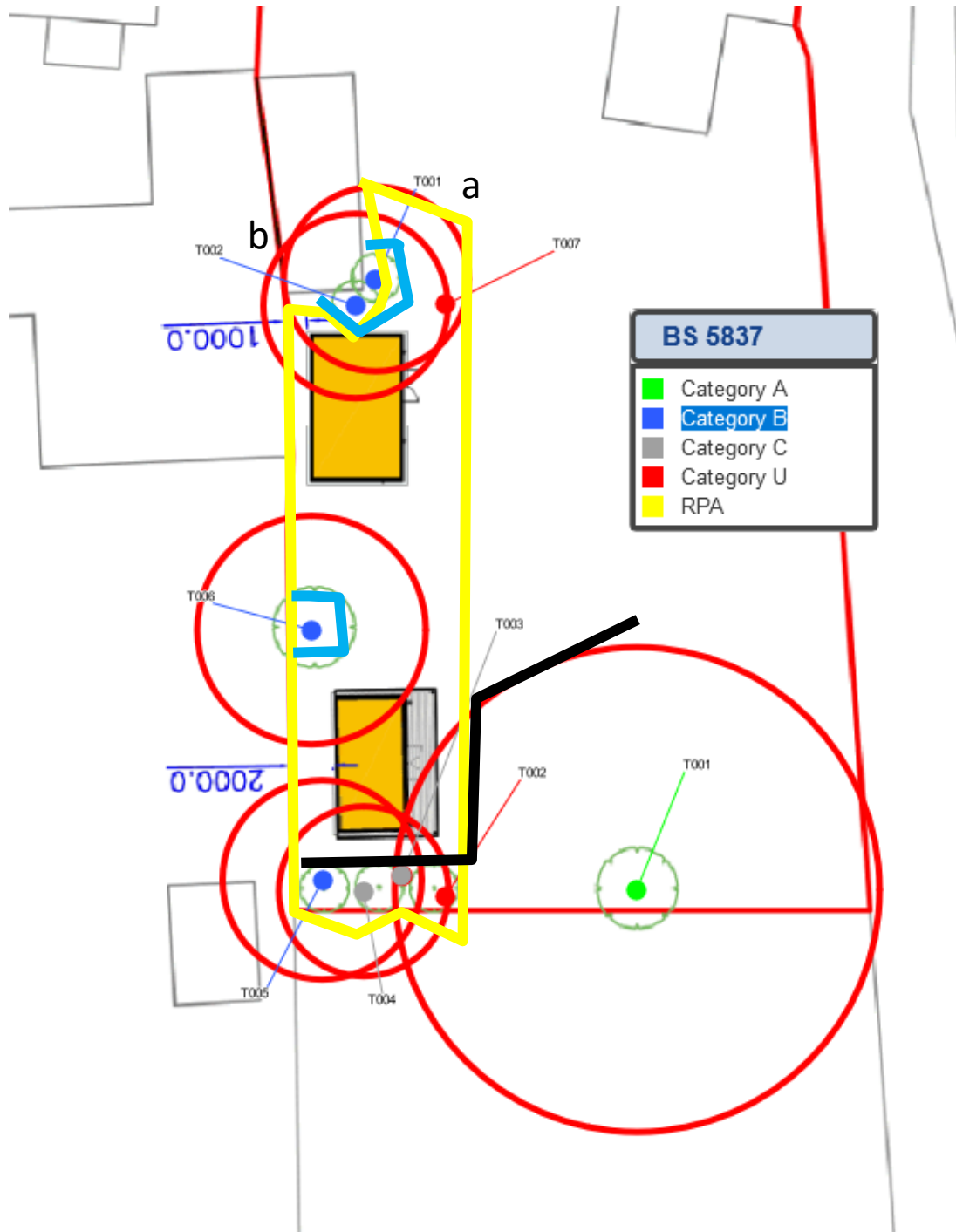

## **8) Arboricultural Implications Assessment**

### **8.1) Impact on trees**

The erection of two modular garden buildings is proposed at 16 Main Street Hotham, East Riding of Yorkshire. There are a number of trees located in the rear garden of the property. The trees do not figure significantly in the street scene of the Hotham Conservation Area. T002(Dead Birch) and T007 (Prunus in decline) are the only trees scheduled for removal. The proposed garden buildings are within the Root Protection Areas (RPA) of a number of trees. However, I have recommended that ground protection be put in place to protect roots from damage during the installation of the buildings. Box Protection and Class 1 protective fencing is to be erected (See Tree Protection Plan) to protect the closest stems and roots from being damaged during the development phase of this project. All trees except T001 will require pruning. This will mostly be a crown lift and individual branch reduction to facilitate the project.

The main concern regarding the locations of the 2 garden buildings of the new garage is the effect on the roots of the building foundations. Much of the damage that can be done to trees by construction occurs below the ground, and so when planning to build within an RPA foundation design is critical. One of the most significant issues of building around trees is severing roots. Essentially this means that traditional trench foundations and concrete slabs in RPAs are out, unless they will only clip a small area. However, a preferred alternative to traditional foundations when building in RPAs is to use small diameter piles. Piled foundations limit potential damage to roots during installation and ensure no part of the tree bears the loads from the structure.

Any excavations which must be undertaken within the root protection area would have to be carried out carefully by hand, avoiding damage to the protective bark covering larger roots. Roots, whilst exposed, should be wrapped in dry, clean hessian sacking to prevent desiccation and to protect from rapid temperature changes. Roots smaller than 25 mm diameter may be pruned back, preferably to a side branch, using a proprietary cutting tool such as bypass secateurs or handsaws. Roots larger than 25 mm should only be severed following consultation with an arboriculturist, as they may be essential to the tree's health and stability. Prior to backfilling, any hessian wrapping should be removed and retained roots should be surrounded with sharp sand (builders' sand should not be used because of its high salt content which is toxic to tree roots), or other loose granular fill, before soil or other material is replaced. This material should be free of contaminants and other foreign objects potentially injurious to tree roots. Any foundations should take in account the properties of tree roots, especially if shrinkable clay soils are present.

There are two types of piling systems that can be employed within the RPA. One is Micro piling the other is Screw Piling. Micro piling involves hitting the piles into the ground whilst screw piles are rotated into the ground using a handheld or excavator mounted torque head. Installation occurs at a constant speed, inducing no vibration and requiring no pre-auguring. A screw pile displaces a comparatively small amount of soil & tree roots compared to a traditional micro pile. The helices attached to the screw pile shaft are deliberately made from thin steel plate, with a blunt protruding edge to ensure that where possible, roots are moved out of the way during installation rather than severing them. The pile shaft is considerable smaller than that of a micro pile so again, displacement of soil and tree roots is minimised. Should a micro pile encounter a root, the root would be severed.

Clearly there is no way that a pile can be installed through an existing root system without causing some damage, however it is key to the health of the tree to minimise this effect as much as possible. As previously discussed, micro piling requires the removal of all material in the position of the pile, including any tree roots encountered. Typically screw piles are



used in combination with a cast concrete ground beam system. This system is generally flexible enough to allow pile to be adjusted on site if any large tree roots are encountered and need to be avoided.

Another method that could be employed is a procedure known as Pad, Pier and Beam. Each pad is excavated by hand at a spacing of approximately 2.5m c/c. If main roots are encountered, adjust pad positions to avoid roots and revise design accordingly. Concrete foundation pads are then poured below main root level. Brick piers are constructed upon each pad foundation. A series of steel beams are then erected and encased in concrete using suspended shuttering. A superstructure can then be erected using, using load spread mats for all working areas, avoiding point loads upon the ground surface from palletised materials.

It is quite clear in this case that traditional concrete slab and trench foundations would cause too much damage to the tree roots within the RPA. I would recommend the use of one of the methods mentioned above. The modular building proposed adjacent to T001a and T002b could be moved away from the main stems of these trees towards T006. This could avoid damage occurring to larger roots found closer to the main stem. No construction machinery or pedestrian footfall should enter the RPA without ground protection being in place. If the recommendations, I have put forward are adopted and the construction work carried out with due diligence, the proposed construction of the 2 garden buildings should not be detrimental to tree health.

### **8.2) The construction exclusion zone: barriers and ground protection**

All trees which are being retained on site should be protected by barriers and/or ground protection, as recommended. Vertical barriers should be erected, and ground protection installed before any materials or machinery is brought onto the site and before any demolition, development or stripping of soil commences. Once erected, barriers and ground protection should be regarded as sacrosanct, and should not be removed or altered without prior recommendation by an arboriculturist and approval of the local planning authority.

### **8.3) Barriers**

Barriers should be fit for the purpose of excluding construction activity and appropriate to the degree and proximity of work taking place around the retained tree(s). On all sites, special attention should be paid to ensuring that barriers remain rigid and complete.

In most cases, barriers should consist of a scaffold framework in accordance with Figure 2 comprising a vertical and horizontal framework, well braced to resist impacts, with vertical tubes spaced at a maximum interval of 3 m. Onto this, weld mesh panels should be securely fixed with wire or scaffold clamps. Weld mesh panels on rubber or concrete feet are not resistant to impact and should not be used.

+

NOTE the above is preferred because it is readily available, resistant to impact, can be re-used and enables inspection of the protected area.

GROUND PROTECTION ERECTED ON SITE TO PROTECT TREES SHOULD BE CLEARLY SIGNED AS BELOW.

# TREE PROTECTION



# DO NOT MOVE

#### **8.4) Access and Space for Construction**

All building materials will be stored on hard standing or 15 metres away from any retained trees.

#### **8.5) Services**

No details of services have been provided.

## Appendix A Tree Protection

### Tree Protection Fencing

#### Class 1 Fencing

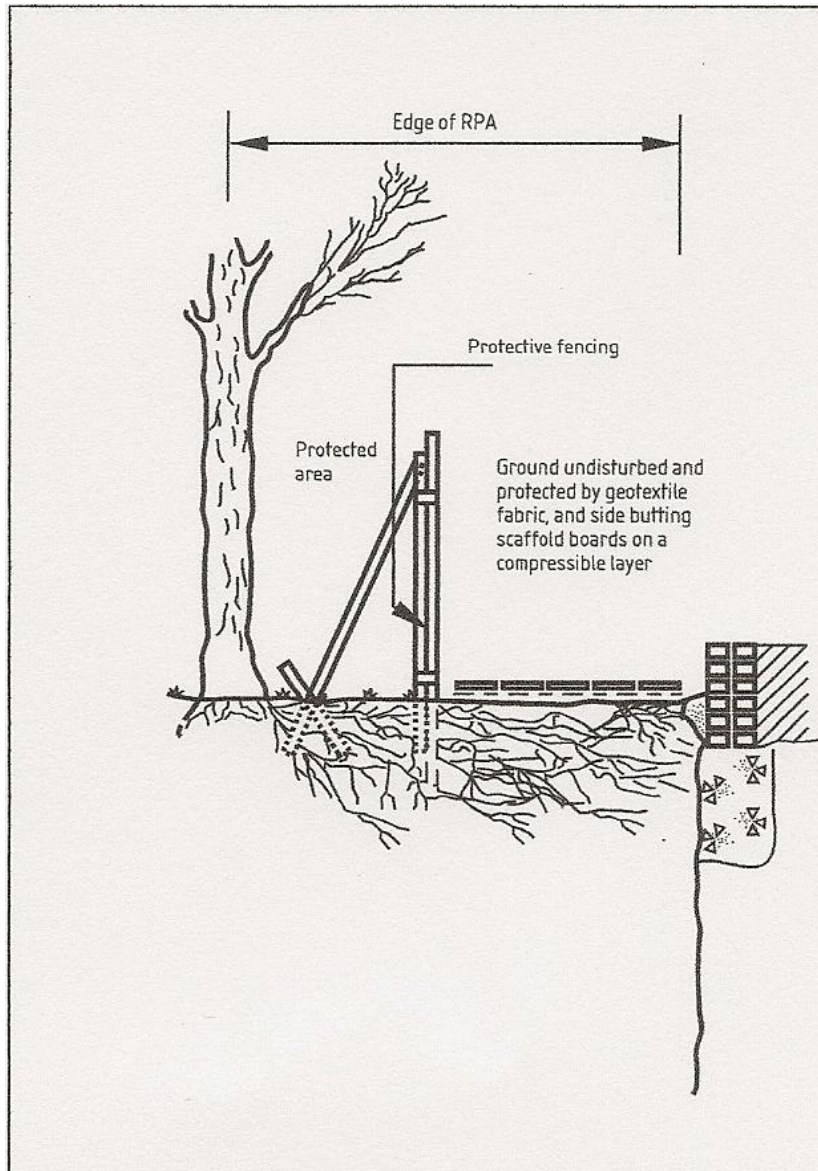



## Class 2 Fencing

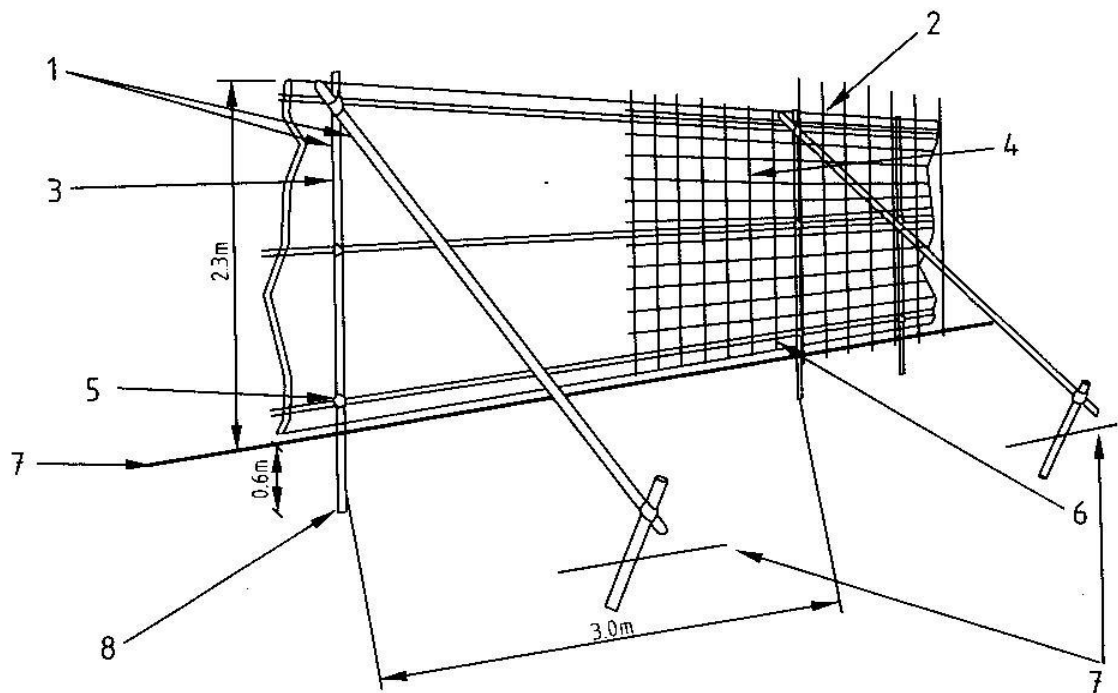

- |  |  |
|--|--|
| 1 Standard scaffold poles  | 5 Standard clamps  |
| 2 Uprights to be driven into the ground  | 6 Wire twisted and secured on inside face of fencing to avoid easy dismantling |
| 3 Panels secured to uprights with wire ties and where necessary standard scaffold clamps | 7 Ground level   |
| 4 Weldmesh wired to the uprights and horizontals   | 8 Approx. 0.6 m driven into the ground   |

**Figure 2 — Protective barrier**

Ridings Forestry UK Ltd

**Appendix B**  
**Tree Survey**

Ridings Forestry UK Ltd

## **Tree Work Recommendations**