

NOTES:-
The accuracy and content of this drawing are dependent on the original specification and ED should be consulted before use in other works.
Where underground services are shown, all reasonable care has been taken within the limits of the original specification and equipment. Before use of this information the user should ensure that any utility companies of the construction and accuracy of such services are confirmed by ground conditions and the location equipment no guarantee can be given that any services have been represented. This drawing should be used as a reference only.
All reasonable care has been taken in the survey and the specification and content of this drawing are dependent on the original specification and ED should be consulted before use in other works.
Our aim is to produce the best possible results within the specification and cost constraints of our clients. Any comments are most welcome.
Levels shown at kerbs are channel level unless stated.

LEGEND

Features:	OP Overhead Pipe	BR Brickwork
AP Air Valve	PP Potting Water	BS Barbed Wire
AS Asphalt	BP Boundary	CD Chain Drive
BA Barren	BR Bricks	CI Cast Iron
BS Brickwork	BR Bricks	CI Cast Iron
BT Boundary	BR Bricks	CI Cast Iron
BU Bus Stop	BR Bricks	CI Cast Iron
CA Concrete	BR Bricks	CI Cast Iron
CB Concrete	BR Bricks	CI Cast Iron
CC Concrete	BR Bricks	CI Cast Iron
CD Chain Drive	BR Bricks	CI Cast Iron
CE Concrete	BR Bricks	CI Cast Iron
CF Concrete	BR Bricks	CI Cast Iron
CG Concrete	BR Bricks	CI Cast Iron
CH Concrete	BR Bricks	CI Cast Iron
CI Cast Iron	BR Bricks	CI Cast Iron
CL Concrete	BR Bricks	CI Cast Iron
CM Concrete	BR Bricks	CI Cast Iron
CN Concrete	BR Bricks	CI Cast Iron
CO Concrete	BR Bricks	CI Cast Iron
CP Concrete	BR Bricks	CI Cast Iron
CQ Concrete	BR Bricks	CI Cast Iron
CR Concrete	BR Bricks	CI Cast Iron
CS Concrete	BR Bricks	CI Cast Iron
CT Concrete	BR Bricks	CI Cast Iron
CU Concrete	BR Bricks	CI Cast Iron
CV Concrete	BR Bricks	CI Cast Iron
CW Concrete	BR Bricks	CI Cast Iron
CX Concrete	BR Bricks	CI Cast Iron
CY Concrete	BR Bricks	CI Cast Iron
CZ Concrete	BR Bricks	CI Cast Iron
DA Dam	BR Bricks	CI Cast Iron
DB Dam	BR Bricks	CI Cast Iron
DC Dam	BR Bricks	CI Cast Iron
DD Dam	BR Bricks	CI Cast Iron
DE Dam	BR Bricks	CI Cast Iron
DF Dam	BR Bricks	CI Cast Iron
DG Dam	BR Bricks	CI Cast Iron
DH Dam	BR Bricks	CI Cast Iron
DI Dam	BR Bricks	CI Cast Iron
DJ Dam	BR Bricks	CI Cast Iron
DK Dam	BR Bricks	CI Cast Iron
DL Dam	BR Bricks	CI Cast Iron
DM Dam	BR Bricks	CI Cast Iron
DN Dam	BR Bricks	CI Cast Iron
DO Dam	BR Bricks	CI Cast Iron
DP Dam	BR Bricks	CI Cast Iron
DQ Dam	BR Bricks	CI Cast Iron
DR Dam	BR Bricks	CI Cast Iron
DS Dam	BR Bricks	CI Cast Iron
DT Dam	BR Bricks	CI Cast Iron
DU Dam	BR Bricks	CI Cast Iron
DV Dam	BR Bricks	CI Cast Iron
DW Dam	BR Bricks	CI Cast Iron
DX Dam	BR Bricks	CI Cast Iron
DY Dam	BR Bricks	CI Cast Iron
DZ Dam	BR Bricks	CI Cast Iron
EA Earth	BR Bricks	CI Cast Iron
EB Earth	BR Bricks	CI Cast Iron
EC Earth	BR Bricks	CI Cast Iron
ED Earth	BR Bricks	CI Cast Iron
EE Earth	BR Bricks	CI Cast Iron
EF Earth	BR Bricks	CI Cast Iron
EG Earth	BR Bricks	CI Cast Iron
EH Earth	BR Bricks	CI Cast Iron
EI Earth	BR Bricks	CI Cast Iron
EJ Earth	BR Bricks	CI Cast Iron
EK Earth	BR Bricks	CI Cast Iron
EL Earth	BR Bricks	CI Cast Iron
EM Earth	BR Bricks	CI Cast Iron
EN Earth	BR Bricks	CI Cast Iron
EO Earth	BR Bricks	CI Cast Iron
EP Earth	BR Bricks	CI Cast Iron
EQ Earth	BR Bricks	CI Cast Iron
ER Earth	BR Bricks	CI Cast Iron
ES Earth	BR Bricks	CI Cast Iron
ET Earth	BR Bricks	CI Cast Iron
EU Earth	BR Bricks	CI Cast Iron
EV Earth	BR Bricks	CI Cast Iron
EW Earth	BR Bricks	CI Cast Iron
EX Earth	BR Bricks	CI Cast Iron
EY Earth	BR Bricks	CI Cast Iron
EZ Earth	BR Bricks	CI Cast Iron

Scale: 1:100
Date: 19/06/2021
Drawing No: 19674/E/01-01

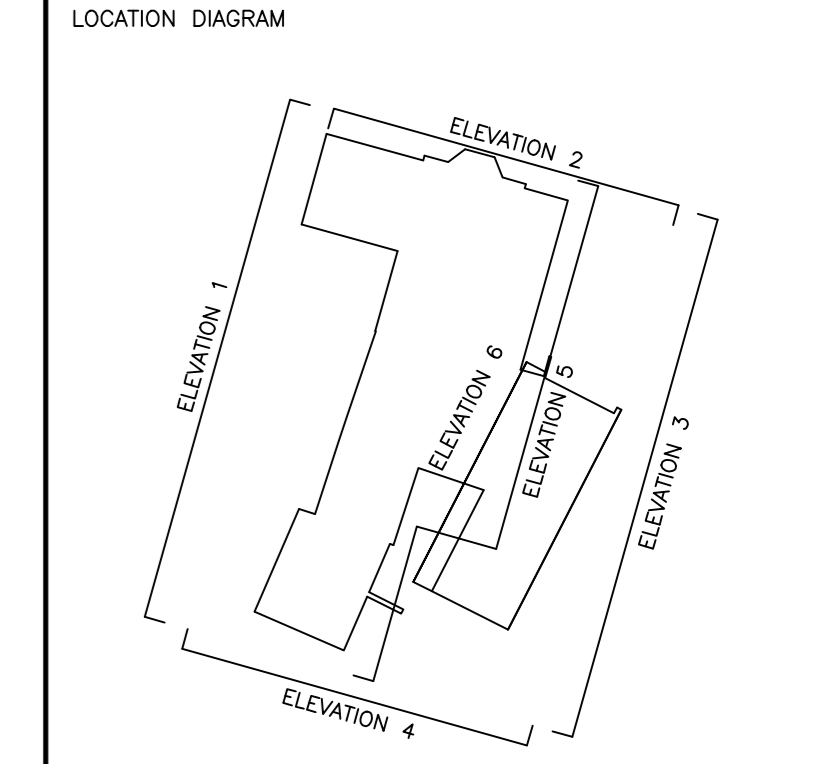

Rev	Job No	Date	Revision	Detail	Surveyor	CHKD

CLIENT
Emswell Parish Council
Bury St Edmunds
Suffolk
IP30 9HX

PROJECT
External Elevations Survey
Railway Tavern
School Road
Emswell
Suffolk, IP30 9EE

Job No.	Surveyor	Checked	Date	Scale
19674	A. Parker	RAK	June 2021	1:100

EDI SURVEYS LTD
 151-165 Roneagh Road, Ipswich, Suffolk IP2 0AH
 Telephone | 01473 211222 Fax | 01473 221660
 Email | info@edisurveys.co.uk
 Our Services: Topographic Surveys, Access Building Surveys, GPS, Boundary and Corridor, 3D Laser Scanning, Utility Surveys and Drainage Investigations.
 Call us on 01473 211222 or visit our website and find out more.
www.edisurveys.co.uk

DRAWING No: 19674/E/01-01

REV: -

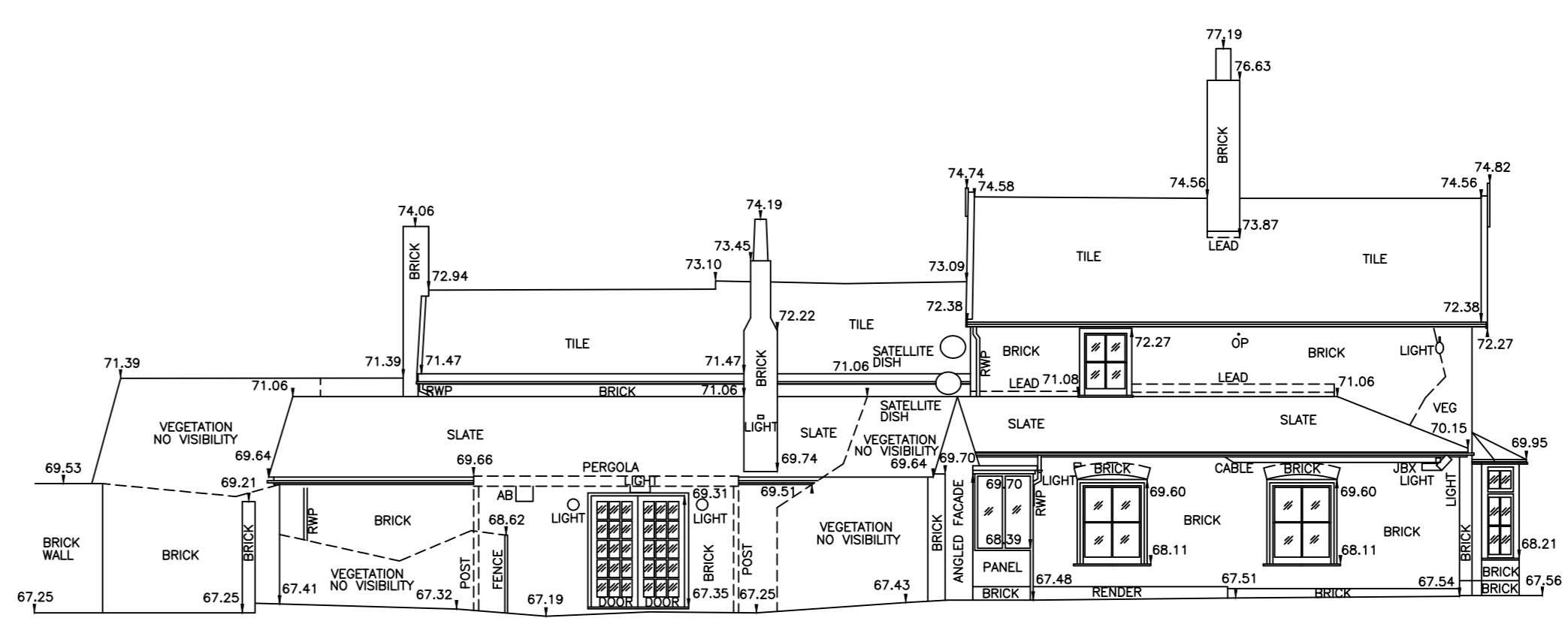

AOD 60.00m

ELEVATION 3

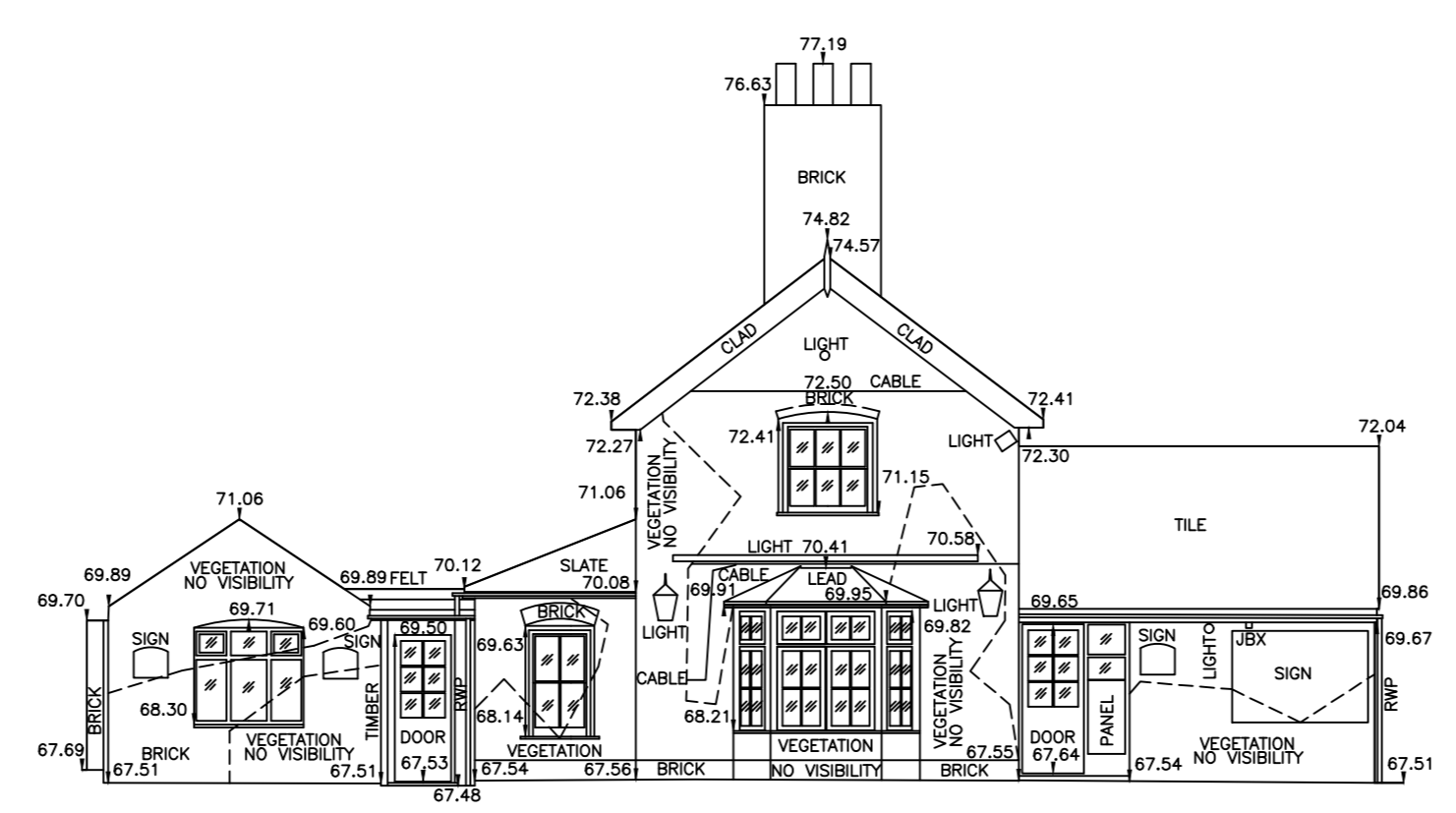

AOD 60.00m

ELEVATION 2

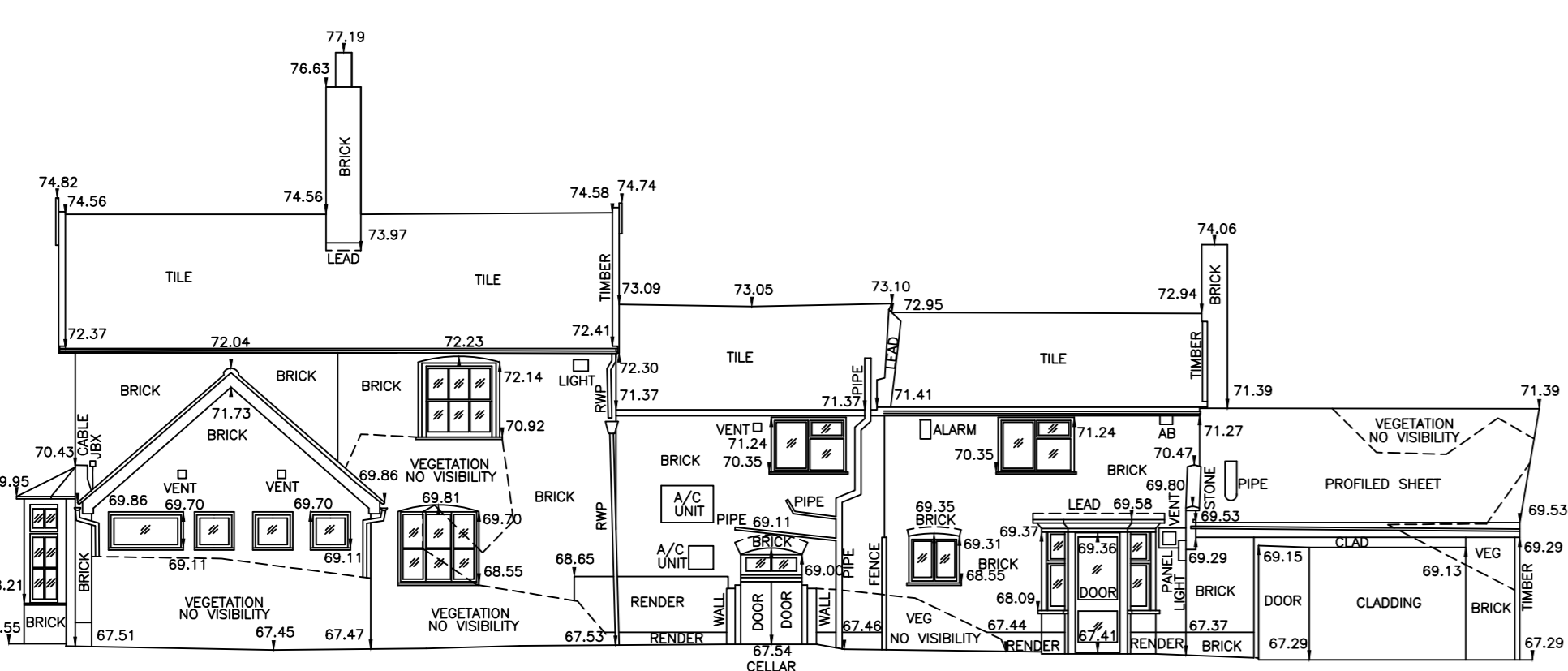

AOD 60.00m

ELEVATION 1

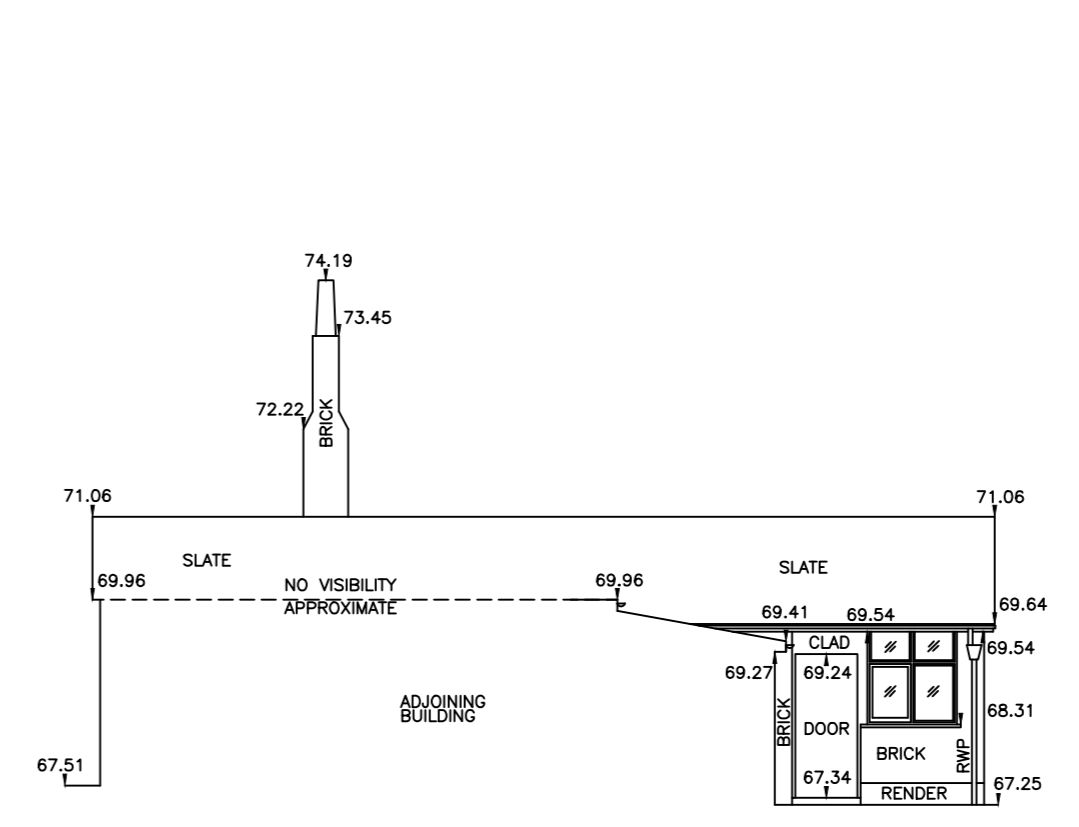

AOD 60.00m

ELEVATION 6

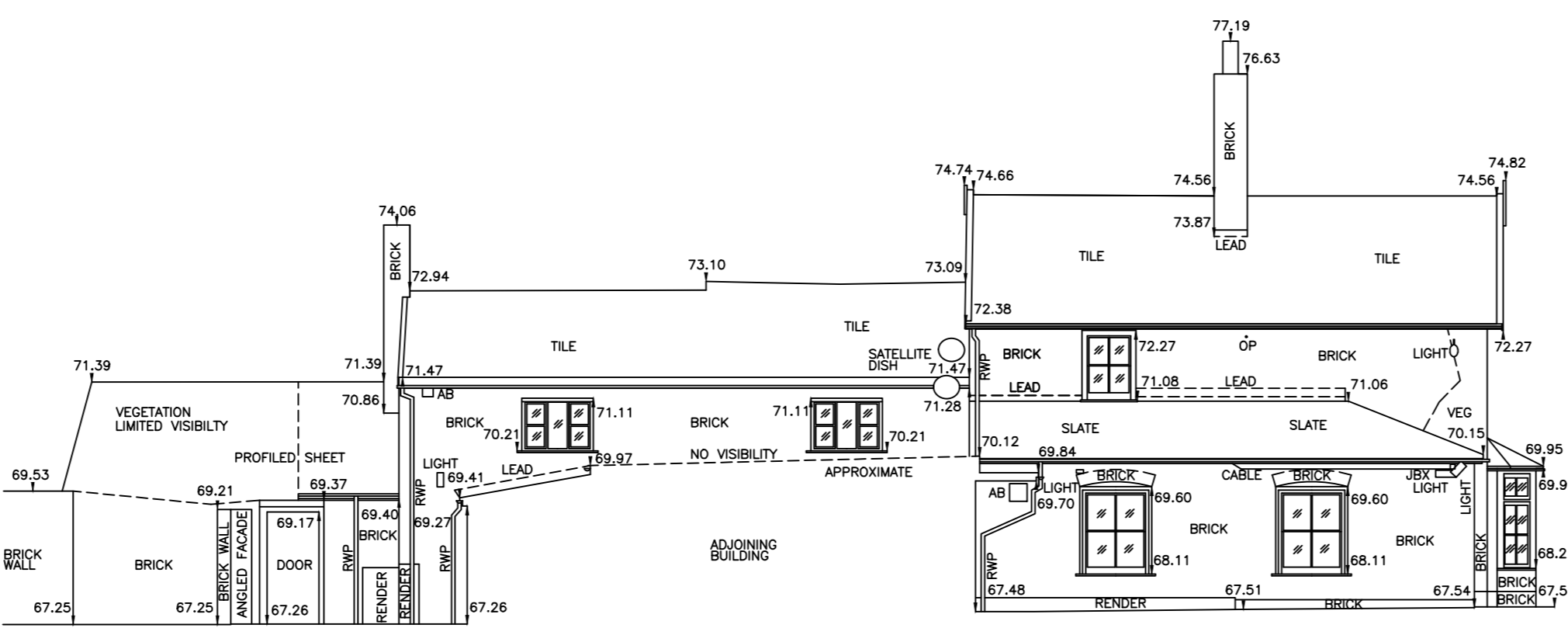

AOD 60.00m

ELEVATION 5

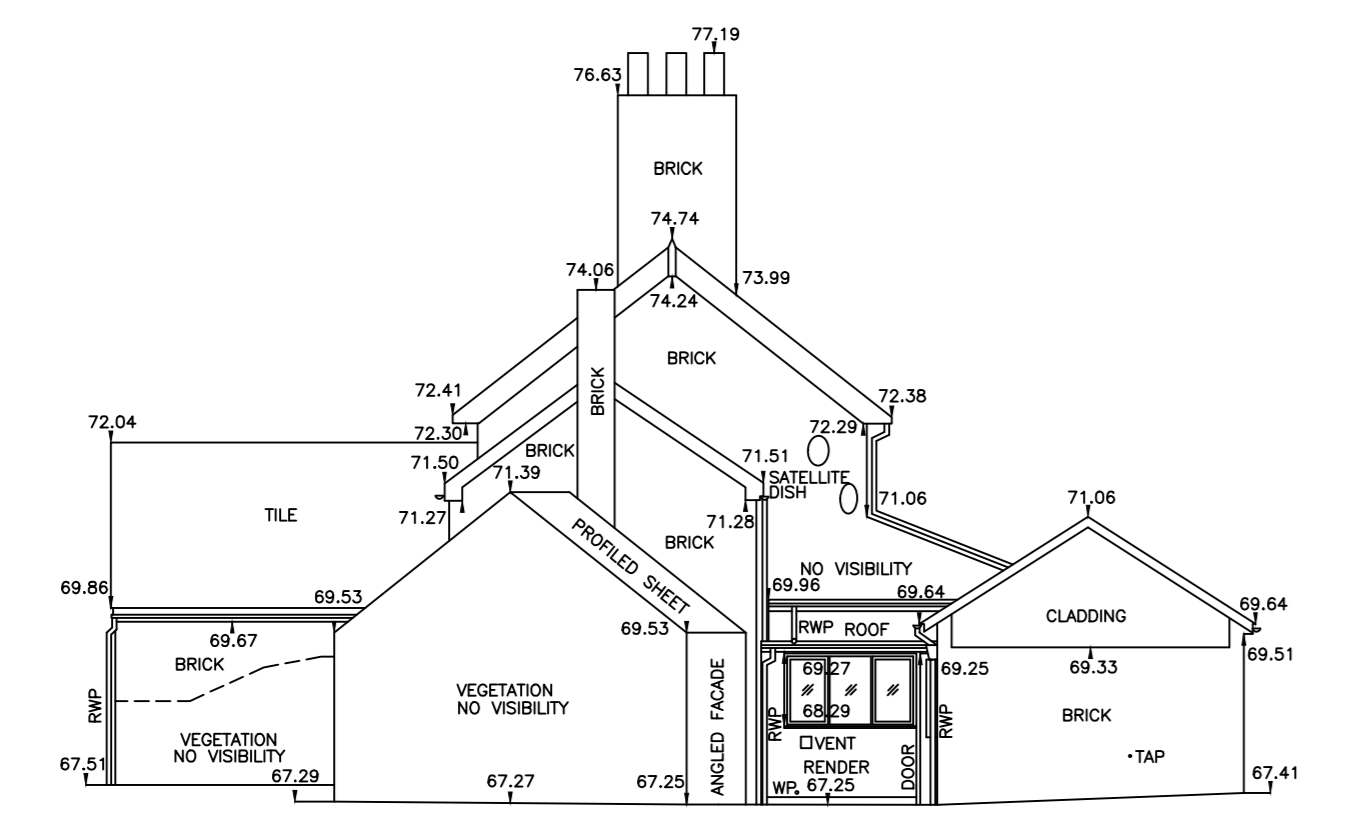

AOD 60.00m

ELEVATION 4