



Heat Pump Datasheet

Installation of Air Source Heat pumps



Hill Mead Primary School

Moorland Road, Lambeth, SW9 8UE

Document Number	Revision	Issue Date
CN2302-ALT-HIL-XX-DT-Z-0001	P01	28/07/2023

PUZ-HWM140VHA(-BS)

Ecodan R32

Monobloc Air Source Heat Pump



Key Features:	Key Benefits:
<ul style="list-style-type: none"> ■ A+++ high efficiency system ■ Compact design ■ Maintains full heating capacity at low temperatures ■ Zero carbon solution ■ MELCloud enabled 	<ul style="list-style-type: none"> ■ Ultra low running cost ■ Minimal installation space required ■ Confident and quick product selection ■ Help to tackle the climate crisis ■ Remote control, monitoring, maintenance and technical support



ecodan[®]
Renewable Heating Technology

OUTDOOR UNIT		PUZ-HWM140VHA(-BS)
HEAT PUMP SPACE HEATER - 55°C	ErP Rating	A++
	η_s	131%
HEAT PUMP SPACE HEATER - 35°C	ErP Rating	A+++
	η_s	176%
HEAT PUMP COMBINATION HEATER - Large Profile ¹	ErP Rating	A+
	η_{wh}	130%
HEATING ² (A-7/W35)	Capacity (kW)	14
	Power Input (kW)	5.71
	COP	2.45
OPERATING AMBIENT TEMPERATURE (°C DB)		-28 ~ +35
SOUND DATA ³	Pressure Level at 1m (dBA)	53
	Power Level (dBA) ⁴	67
WATER DATA	Pipework Size (mm)	28
	Flow Rate (l/min)	40.1
	Water Pressure Drop (kPa)	20
DIMENSIONS (mm)	Width	1020
	Depth	330 + 30*7
	Height	1350
WEIGHT (kg)		132
ELECTRICAL DATA	Electrical Supply	220-240v, 50Hz
	Phase	Single
	Nominal Running Current [MAX] (A) ⁵	13.8 [35]
	Fuse Rating - MCB Sizes (A) ⁶	40
REFRIGERANT CHARGE (kg) / CO ₂ EQUIVALENT (t)	R32 (GWP 675)	3.3

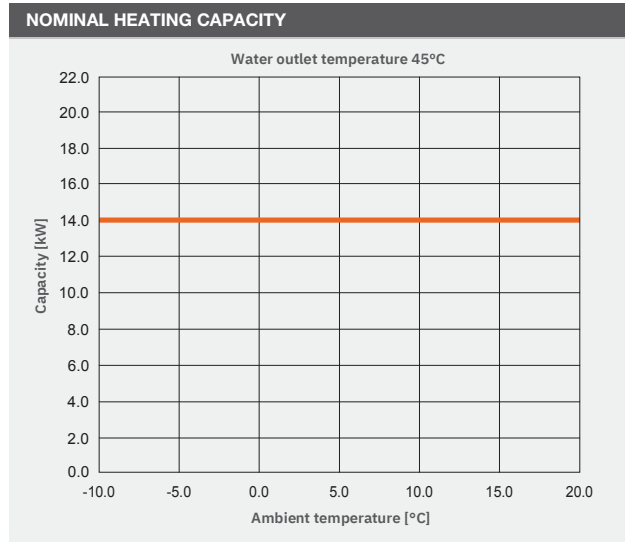

Notes:

- ¹ Combination with E*PT20X Cylinder
 - ² Under normal heating conditions at outdoor temp: -7°CDB / -8°CWB, outlet water temp 35°C, inlet water temp 30°C.
 - ³ Under normal heating conditions at outdoor temp: 7°CDB / 6°CWB, outlet water temp 55°C, inlet water temp 47°C as tested to BS EN14511.
 - Low Noise mode accessory (reference PAC-SA89TA-EP) available for VHA chassis.
 - ⁴ Sound power level tested to BS EN12102.
 - ⁵ Under nominal heating conditions at outdoor temp: 7°C, outlet water temp: 35°C.
 - ⁶ MCB Sizes BS EN60898-2 & BS EN60947-2.
 - ⁷ Grille.
- η_s is the seasonal space heating energy efficiency (SSHEE) η_{wh} is the water heating energy efficiency

PUZ-HWM140VHA(-BS) DIMENSIONS

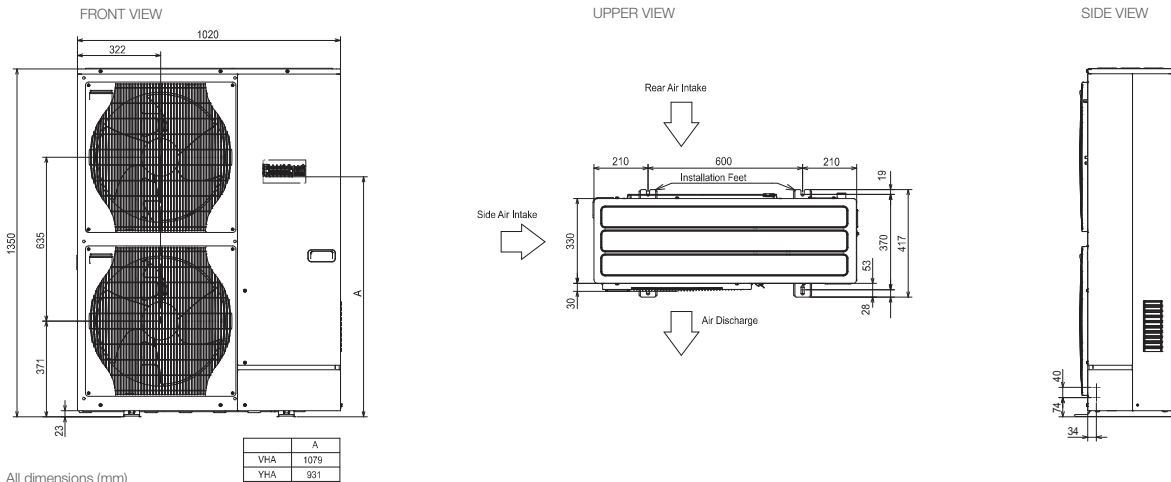

MITSUBISHI ELECTRIC
Changes for the Better

Telephone: 01707 282880
email: heating@meuk.mee.com
heating.mitsubishielectric.co.uk

[@meuk_les](#) / [@green_gateway](#) |
 [Mitsubishi Electric Living Environmental Systems UK](#) |
 [Mitsubishi Electric Cooling and Heating UK](#) |
 [mitsubishielectricuk_les](#) |
 [Mitsubishi Electric Living Environmental Systems UK](#) |
 [BLOG](#) thehub.mitsubishielectric.co.uk

UNITED KINGDOM Mitsubishi Electric Europe Living Environment Systems Division, Travellers Lane, Hatfield, Hertfordshire, AL10 8XB, England. Telephone: 01707 282880 Fax: 01707 278881
IRELAND Mitsubishi Electric Europe, Westgate Business Park, Ballymount, Dublin 24, Ireland. Telephone: (01) 419 8800 Fax: (01) 419 8890 International code: (003531)

Country of origin: United Kingdom - Japan - Thailand - Malaysia. ©Mitsubishi Electric Europe 2020. Mitsubishi and Mitsubishi Electric are trademarks of Mitsubishi Electric Europe B.V. The company reserves the right to make any variation in technical specification to the equipment described, or to withdraw or replace products without prior notification or public announcement. Mitsubishi Electric is constantly developing and improving its products. All descriptions, illustrations, drawings and specifications in this publication present only general particulars and shall not form part of any contract. All goods are supplied subject to the Company's General Conditions of Sale, a copy of which is available on request. Third-party product and brand names may be trademarks or registered trademarks of their respective owners.

Note: Refer to 'Installation Manual' and 'Instruction Book' for further 'Technical Information'. The fuse rating is for guidance only and please refer to the relevant databook for detailed specification. It is the responsibility of a qualified electrician/electrical engineer to select the correct cable size and fuse rating based on current regulation and site specific conditions. Mitsubishi Electric's air conditioning equipment and heat pump systems contain a fluorinated greenhouse gas, R410A (GWP:2088), R32 (GWP:675), R407C (GWP:1774), R134a (GWP:1430), R513A (GWP:631), R454B (GWP:466), R1234ze (GWP:7) or R1234yf (GWP:4). *These GWP values are based on Regulation (EU) No 517/2014 from IPCC 4th edition. In case of Regulation (EU) No.626/2011 from IPCC 3rd edition, these are as follows. R410A (GWP:1975), R32 (GWP:550), R407C (GWP:1650) or R134a (GWP:1300).

Effective as of September 2020



Air to Water Heat Pump

PUZ-HWM140HA series

INSTALLATION MANUAL

For safe and correct use, read this manual and the indoor unit installation manual thoroughly before installing the outdoor unit. English is original. The other languages versions are translation of the original.

INSTALLATIONSHANDBUCH

Aus Sicherheitsgründen und zur richtigen Verwendung vor der Installation der Außenanlage das vorliegende Handbuch und die Installationsanleitung der Innenanlage gründlich durchlesen. Das Original ist in Englisch. Die anderen Sprachversionen sind vom Original übersetzt.

MANUEL D'INSTALLATION

Avant d'installer l'appareil extérieur, lire attentivement ce manuel, ainsi que le manuel d'installation de l'appareil intérieur pour une utilisation sûre et correcte. L'anglais est l'original. Les versions fournies dans d'autres langues sont des traductions de l'original.

INSTALLATIEHANDLEIDING

Lees voor een veilig en juist gebruik deze handleiding en de installatiehandleiding van het binnenapparaat zorgvuldig door voordat u met het installeren van het buitenapparaat begint. Het Engels is het origineel. De andere taalversies zijn vertalingen van het origineel.

MANUAL DE INSTALACIÓN

Para un uso correcto y seguro, lea detalladamente este manual y el manual de instalación de la unidad interior antes de instalar la unidad exterior. El idioma original del documento es el inglés. Las versiones en los demás idiomas son traducciones del original.

MANUALE DI INSTALLAZIONE

Per un uso sicuro e corretto, leggere attentamente il presente manuale ed il manuale d'installazione dell'unità interna prima di installare l'unità esterna. Il testo originale è redatto in lingua inglese. Le altre versioni linguistiche rappresentano traduzioni dell'originale.

ΕΓΧΕΙΡΙΔΙΟ ΟΔΗΓΙΩΝ ΕΓΚΑΤΑΣΤΑΣΗΣ

Για σωστή και ασφαλή χρήση, διαβάστε προσεκτικά αυτό το εγχειρίδιο καθώς και το εγχειρίδιο εγκατάστασης της εσωτερικής μονάδας, προτού εγκαταστήσετε την εξωτερική μονάδα. Η γλώσσα του πρωτοτύπου είναι η αγγλική. Οι εκδόσεις άλλων γλωσσών είναι μεταφράσεις του πρωτοτύπου.

MANUAL DE INSTALAÇÃO

Para uma utilização segura e correcta, leia atentamente este manual e o manual de instalação da unidade interior antes de instalar a unidade exterior. O idioma original é o inglês. As versões em outros idiomas são traduções do idioma original.

INSTALLATIONS MANUAL

Læs af sikkerhedshensyn denne manual samt manualen til installation af indendørsenheden grundigt, før du installerer udendørsenheden. Engelsk er originalsproget. De andre sprogversioner er oversættelser af originalen.

INSTALLATIONS MANUAL

Läs bruksanvisningen och inomhusenhetens installationshandbok noga innan du installerar utomhusenhet för säker och korrekt användning. Engelska är originalspråket. De övriga språkversionerna är översättningar av originalet.

INSTALLASJONSHÅNDBOK

For å sikre trygg og riktig bruk skal denne håndboken samt installasjonshåndboken for innendørsenheten leses grundig igjennom før enheten installeres. Engelsk er originalspråket. De andre språkversjonene er oversettelser av originalen.

ASENNUSOPAS

Turvallisen ja asianmukaisen käytön varmistamiseksi lue tämä opas sekä sisäyksikön asennusopas huolellisesti ennen ulkoyksikön asentamista. Alkuperäiskieli on englanti. Muut kieliversiot ovat alkuperäisen käännöksiä.

NÁVOD K MONTÁŽI

Kvůli zajištění bezpečného a správného používání si před montáží vnější jednotky pečlivě přečtěte tento návod i návod k montáži vnitřní jednotky. Verze v angličtině je originál. Ostatní jazykové verze jsou překladem originálu.

INSTRUKCJA MONTAŻU

Aby zapewnić bezpieczne i prawidłowe korzystanie z urządzenia, przed montażem jednostki zewnętrznej należy dokładnie zapoznać się z treścią niniejszej instrukcji oraz instrukcji montażu jednostki wewnętrznej. Originalną instrukcję sporządzono w języku angielskim. Pozostałe wersje językowe zostały przetłumaczone z oryginału.

РЪКОВОДСТВО ЗА МОНТАЖ

За безопасно и правилно използване, прочетете внимателно това ръководство и ръководството за монтаж на вътрешното тяло, преди да монтирате външното тяло. Версията на английски език е оригинал. Версиите на други езици са превод от оригинала.

NÁVOD NA INŠTALÁCIU

V záujme bezpečného a správneho používania si pred inštaláciou exteriérovej jednotky pozorne prečítajte tento návod a návod na inštaláciu interiérovej jednotky. Pôvodným jazykom je angličtina. Ostatné jazykové verzie sú prekladom originálu.

TELEPÍTÉSI KÉZIKÖNYV

A biztonságos és helyes használat érdekében alaposan olvassa el ezt a használati kézikönyvet és a beltéri egység telepítési kézikönyvét a kültéri egység felszerelése előtt. A dokumentum eredeti nyelve az angol. A más nyelvű változatok az angol eredeti fordításai.

NAMESTITVENI PRIROČNIK

Za varno in pravilno uporabo natančno preberite ta navodila za uporabo in namestitveni priročnik za notranjo enoto, preden namestite zunanjo enoto. Izvirni jezik je angleščina. Različice v drugih jeziki so prevodi izvirnika.

MANUAL DE INSTALARE

Pentru a utiliza aparatul corect și în siguranță, citiți în întregime acest manual, precum și manualul de instalare al unității interioare înainte de a instala unitatea exterioră. Originalul este în limba engleză. Versiunile în alte limbi reprezintă traducerea originalului.

PAIGALDUSJUHEND

Ohutu ja õige kasutuse tagamiseks lugege see juhend ja siseseadme paigaldusjuhend enne välisseadme paigaldamist põhjalikult läbi. Originaal on inglise keeles. Teistes keeltes versioonid on originaali tõlked.

MONTĀŽAS ROKASGRĀMATA

Lai nodrošinātu pareizu un drošu iekārtas lietošanu, pirms ārējās iekārtas uzstādīšanas rūpīgi izlasiet šo rokasgrāmatu un iekšējās iekārtas montāžas rokasgrāmatu. Dokumenta oriģināls ir angļu valodā. Pārējo valodu versijas ir oriģināla tulkojumi.

MONTAVIMO VADOVAS

Kad saugiai ir tinkamai naudotumėte, prieš montuodami lauko įrenginį perskaitykite šį vadovą ir vidinio įrenginio montavimo vadovą. Anglų yra originali kalba. Kitų kalbų versijos yra originalios kalbos vertimas.

PRIRUČNIK ZA POSTAVLJANJE

Radi sigurne i pravilne uporabe pročitajte pažljivo ovaj priručnik i priručnik za postavljanje unutarnje jedinice prije postavljanja vanjske jedinice. Izvorni tekst je na engleskom jeziku. Ostale jezične varijante predstavljaju prijevod tog teksta.

UPUTSTVO ZA UGRADNJU

Radi bezbedne i ispravne upotrebe, detaljno pročitajte ovo uputstvo i uputstvo za ugradnju unutrašnje jedinice pre nego što ugradite spoljnu jedinicu. Engleski je original. Verzije na drugim jezicima su prevod originala.

FOR INSTALLER

English

FÜR INSTALLATEUR

Deutsch

POUR L'INSTALLATEUR

Français

VOOR DE INSTALLATEUR

Nederlands

PARA EL INSTALADOR

Español

PER L'INSTALLATORE

Italiano

ΓΙΑ ΑΥΤΟΝ ΠΟΥ ΚΑΝΕΙ ΤΗΝ ΕΓΚΑΤΑΣΤΑΣΗ

Ελληνικά

PARA O INSTALADOR

Português

TIL INSTALLATØREN

Dansk

FÖR INSTALLATÖREN

Svenska

FOR MONTØR

Norsk

ASENTAJALLE

Suomi

PRO MONTÉRA

Čeština

DLA INSTALATORA

Polski

ЗА ИНСТАЛАТОРА

Български

PRE MONTÉRA

Slovenčina

A TELEPÍTŐ RÉSZÉRE

Magyar

ZA MONTERJA

Slovenščina

PENTRU INSTALATOR

Română

PAIGALDAJALE

Eesti

UZSTĀDĪŠANAS SPECIĀLISTAM

Latviski

SKIRTA MONTUOTOJUI

Lietuviškai

ZA INSTALATERA

Hrvatski

ZA INSTALATERA

Srpski



Manual Download



<http://www.mitsubishielectric.com/ldg/ibim/>

- en** Go to the above website to download manuals, select model name, then choose language.
- de** Besuchen Sie die oben stehende Website, um Anleitungen herunterzuladen, wählen Sie den Modellnamen und dann die Sprache aus.
- fr** Rendez-vous sur le site Web ci-dessus pour télécharger les manuels, sélectionnez le nom de modèle puis choisissez la langue.
- nl** Ga naar de bovenstaande website om handleidingen te downloaden, de modelnaam te selecteren en vervolgens de taal te kiezen.
- es** Visite el sitio web anterior para descargar manuales, seleccione el nombre del modelo y luego elija el idioma.
- it** Andare sul sito web indicato sopra per scaricare i manuali, selezionare il nome del modello e scegliere la lingua.
- el** Μεταβείτε στον παραπάνω ιστότοπο για να κατεβάσετε εγχειρίδια. Επιλέξτε το όνομα του μοντέλου και, στη συνέχεια, τη γλώσσα.
- pt** Aceda ao site Web acima indicado para descarregar manuais, seleccione o nome do modelo e, em seguida, escolha o idioma.
- da** Gå til ovenstående websted for at downloade manualer og vælg modelnavn, og vælg derefter sprog.
- sv** Gå till ovanstående webbplats för att ladda ner anvisningar, välj modellnamn och välj sedan språk.
- tr** Kılavuzları indirmek için yukarıdaki web sitesine gidin, model adını ve ardından dili seçin.
- ru** Чтобы загрузить руководства, перейдите на указанный выше веб-сайт; выберите название модели, а затем язык.
- uk** Щоб завантажити керівництва, перейдіть на зазначений вище веб-сайт; виберіть назву моделі, а потім мову.
- bg** Посетете горепосочения уебсайт, за да изтеглите ръководства, като изберете име на модел и след това – език.
- pl** Odwiedź powyższą stronę internetową, aby pobrać instrukcje, wybierz nazwę modelu, a następnie język.
- no** Gå til nettstedet over for å laste ned håndbøker og velg modellnavn, og velg deretter språk.
- fi** Mene yllä mainitulle verkkosivulle ladataksesi oppaat, valitse mallin nimi ja valitse sitten kieli.
- cs** Příručky naleznete ke stažení na internetové stránce zmíněné výše poté, co zvolíte model a jazyk.
- sk** Na webovej stránke vyššie si môžete stiahnuť návody. Vyberte názov modelu a zvolte požadovaný jazyk.
- hu** A kézikönyvek letöltéséhez látogasson el a fenti weboldalra, válassza ki a modell nevét, majd válasszon nyelvet.
- sl** Obiščite zgornjo spletno stran za prenos priročnikov; izberite ime modela, nato izberite jezik.
- ro** Accesați site-ul web de mai sus pentru a descărca manualele, selectați denumirea modelului, apoi alegeți limba.
- et** Kasutusjuhendite allalaadimiseks minge ülaltoodud veebilehele, valige mudeli nimi ja seejärel keel.
- lv** Dodieties uz iepriekš norādīto tīmekļa vietni, lai lejupielādētu rokasgrāmatas; tad izvēlieties modeļa nosaukumu un valodu.
- lt** Norėdami atsisiųsti vadovus, apsilankykite pirmiau nurodytoje žiniatinklio svetainėje, pasirinkite modelio pavadinimą, tada – kalbą.
- hr** Kako biste preuzeli priručnike, idite na gore navedeno web-mjesto, odaberite naziv modela, a potom odaberite jezik.
- sr** Idite na gore navedenu veb stranicu da biste preuzeli uputstva, izaberite ime modela, a zatim izaberite jezik.

Contents

1. Safety precautions	1	5. Electrical work	10
2. Installation location	3	6. System control	12
3. Installing the outdoor unit	7	7. Specifications	12
4. Water piping work	8	8. Serial number	12



Note: This symbol mark is for EU countries only.

This symbol mark is according to the directive 2012/19/EU Article 14 Information for users and Annex IX.

Your MITSUBISHI ELECTRIC product is designed and manufactured with high quality materials and components which can be recycled and reused.

This symbol means that electrical and electronic equipment, at their end-of-life, should be disposed of separately from your household waste.

Please, dispose of this equipment at your local community waste collection/recycling centre.

In the European Union there are separate collection systems for used electrical and electronic product.

Please, help us to conserve the environment we live in!

en

⚠ Caution:

- Do not vent R32 into the Atmosphere:

1. Safety precautions

- ▶ Before installing the unit, make sure you read all the “Safety precautions”.
- ▶ Please report to or take consent by the supply authority before connection to the system.
- ▶ Equipment complying with IEC/EN 61000-3-12 (PUZ-HWM140VHA)

⚠ Warning:

Describes precautions that must be observed to prevent danger of injury or death to the user.

⚠ Caution:

Describes precautions that must be observed to prevent damage to the unit.

After installation work has been completed, explain the “Safety Precautions,” use, and maintenance of the unit to the customer according to the information in the Operation Manual and perform the test run to ensure normal operation. Both the Installation Manual and Operation Manual must be given to the user for keeping. These manuals must be passed on to subsequent users.

⚡ : Indicates a part which must be grounded.

⚠ Warning:

Carefully read the labels affixed to the main unit.

MEANINGS OF SYMBOLS DISPLAYED ON THE UNIT

	WARNING (Risk of fire)	This mark is for R32 refrigerant only. Refrigerant type is written on nameplate of outdoor unit. In case that refrigerant type is R32, this unit uses a flammable refrigerant. If refrigerant leaks and comes in contact with fire or heating part, it will create harmful gas and there is risk of fire.
		Read the OPERATION MANUAL carefully before operation.
		Service personnel are required to carefully read the OPERATION MANUAL and INSTALLATION MANUAL before operation.
		Further information is available in the OPERATION MANUAL, INSTALLATION MANUAL, and the like.

⚠ Warning:

- The unit must not be installed by the user. Ask a dealer or an authorized technician to install the unit. If the unit is installed incorrectly, water leakage, electric shock, or fire may result.
- For installation work, follow the instructions in the Installation Manual and use tools and pipe components specifically made for use with R32 refrigerant. The R32 refrigerant in the HFC system is pressurized 1.6 times the pressure of usual refrigerants. If pipe components not designed for R32 refrigerant are used and the unit is not installed correctly, the pipes may burst and cause damage or injuries. In addition, water leakage, electric shock, or fire may result.
- When installing the unit, use appropriate protective equipment and tools for safety. Failure to do so could cause injuries.
- The unit must be installed according to the instructions in order to minimize the risk of damage from earthquakes, typhoons, or strong winds. An incorrectly installed unit may fall down and cause damage or injuries.
- The unit must be securely installed on a structure that can sustain its weight. If the unit is mounted on an unstable structure, it may fall down and cause damage or injuries.
- If the outdoor unit is installed in a small room, measures must be taken to prevent the refrigerant concentration in the room from exceeding the safety limit in the event of refrigerant leakage. Consult a dealer regarding the appropriate measures to prevent the allowable concentration from being exceeded. Should the refrigerant leak and cause the concentration limit to be exceeded, hazards due to lack of oxygen in the room may result.
- Ventilate the room if refrigerant leaks during operation. If refrigerant comes into contact with a flame, poisonous gases will be released.
- All electric work must be performed by a qualified technician according to local regulations and the instructions given in this manual. The units must be powered by dedicated power lines and the correct voltage and circuit breakers must be used. Power lines with insufficient capacity or incorrect electrical work may result in electric shock or fire.

- This appliance is intended to be used by expert or trained users in shops, in light industry and on farms, or for commercial use by lay persons.
- Use only specified cables for wiring. The wiring connections must be made securely with no tension applied on the terminal connections. Also, never splice the cables for wiring (unless otherwise indicated in this document). Failure to observe these instructions may result in overheating or a fire.
- If the supply cord is damaged, it must be replaced by the manufacturer, its service agent or similarly qualified persons in order to avoid hazard.
- The appliance shall be installed in accordance with national wiring regulations.
- The terminal block cover panel of the outdoor unit must be firmly attached. If the cover panel is mounted incorrectly and dust and moisture enter the unit, electric shock or fire may result.
- When installing or relocating, or servicing the outdoor unit, use only the specified refrigerant (R32) to charge the refrigerant lines. Do not mix it with any other refrigerant and do not allow air to remain in the lines. If air is mixed with the refrigerant, then it can be the cause of abnormal high pressure in the refrigerant line, and may result in an explosion and other hazards. The use of any refrigerant other than that specified for the system will cause mechanical failure or system malfunction or unit breakdown. In the worst case, this could lead to a serious impediment to securing product safety.
- Use only authorized accessories and ask a dealer or an authorized technician to install them. If accessories are incorrectly installed, water leakage, electric shock, or fire may result.
- Do not alter the unit. Consult a dealer for repairs. If alterations or repairs are not performed correctly, water leakage, electric shock, or fire may result.
- The user should never attempt to repair the unit or transfer it to another location. If the unit is installed incorrectly, water leakage, electric shock, or fire may result. If the outdoor unit must be repaired or moved, ask a dealer or an authorized technician.

1. Safety precautions

en

- After installation has been completed, check for refrigerant leaks. If refrigerant leaks into the room and comes into contact with the flame of a heater or portable cooking range, poisonous gases will be released.
- Do not use means to accelerate the defrosting process or to clean, other than those recommended by the manufacturer.
- The appliance shall be stored in a room without continuously operating ignition sources (for example: open flames, an operating gas appliance or an operating electric heater).
- Do not pierce or burn.
- Be aware that refrigerants may not contain an odour.
- Compliance with national gas regulations shall be observed.
- Keep any required ventilation openings clear of obstruction.
- ⊙ Do not use low temperature solder alloy in case of brazing the refrigerant pipes.

- ⊙ When performing brazing work, be sure to ventilate the room sufficiently. Make sure that there are no hazardous or flammable materials nearby. When performing the work in a closed room, small room, or similar location, make sure that there are no refrigerant leaks before performing the work. If refrigerant leaks and accumulates, it may ignite or poisonous gases may be released.
- ⊙ The appliance shall be stored in a well-ventilated area where the room size corresponds to the room area as specified for operation.
- ⊙ Keep gas-burning appliances, electric heaters, and other fire sources (ignition sources) away from the location where installation, repair, and other outdoor unit work will be performed. If refrigerant comes into contact with a flame, poisonous gases will be released.
- ⊙ Do not smoke during work and transportation.

1.1. Before installation

⚠ Caution:

- Do not use the unit in an unusual environment. If the outdoor unit is installed in areas exposed to steam, volatile oil (including machine oil), or sulfuric gas, areas exposed to high salt content such as the seaside, or areas where the unit will be covered by snow, the performance can be significantly reduced and the internal parts can be damaged.
- Do not install the unit where combustible gases may leak, be produced, flow, or accumulate. If combustible gas accumulates around the unit, fire or explosion may result.
- The outdoor unit produces condensation during the heating operation. Make sure to provide drainage around the outdoor unit if such condensation is likely to cause damage.

- When installing the unit in a hospital or communications office, be prepared for noise and electronic interference. Inverters, home appliances, high-frequency medical equipment, and radio communications equipment can cause the outdoor unit to malfunction or breakdown. The outdoor unit may also affect medical equipment, disturbing medical care, and communications equipment, harming the screen display quality.
- When the unit is running, vibrations or the noise of refrigerant running may be heard from the extension piping. Try to avoid installing the piping to thin walls, etc. as much as possible and provide sound insulation with the piping cover, etc.

1.2. Before installation (relocation)

⚠ Caution:

- Be extremely careful when transporting or installing the units. Two or more persons are needed to handle the unit, as it weighs 20 kg or more. Do not grasp the packaging bands. Wear protective gloves to remove the unit from the packaging and to move it, as you can injure your hands on the fins or the edge of other parts.
- Be sure to safely dispose of the packaging materials. Packaging materials, such as nails and other metal or wooden parts may cause stabs or other injuries.

- The base and attachments of the outdoor unit must be periodically checked for looseness, cracks or other damage. If such defects are left uncorrected, the unit may fall down and cause damage or injuries.
- Do not clean the outdoor unit with water. Electric shock may result.

1.3. Before electric work

⚠ Caution:

- Be sure to install circuit breakers. If not installed, electric shock may result.
- For the power lines, use standard cables of sufficient capacity. Otherwise, a short circuit, overheating, or fire may result.
- When installing the power lines, do not apply tension to the cables. If the connections are loosened, the cables can snap or break and overheating or fire may result.

- Be sure to ground the unit. Do not connect the ground wire to gas or water pipes, lightning rods, or telephone grounding lines. If the unit is not properly grounded, electric shock may result.
- Use circuit breakers (ground fault interrupter, isolating switch (+B fuse), and molded case circuit breaker) with the specified capacity. If the circuit breaker capacity is larger than the specified capacity, breakdown or fire may result.

1.4. Before starting the test run

⚠ Caution:

- Turn on the main power switch more than 12 hours before starting operation. Starting operation just after turning on the power switch can severely damage the internal parts. Keep the main power switch turned on during the operation season.
- Before starting operation, check that all panels, guards and other protective parts are correctly installed. Rotating, hot, or high voltage parts can cause injuries.

- Do not touch any switch with wet hands. Electric shock may result.
- Do not touch the refrigerant pipes with bare hands during operation. The refrigerant pipes are hot or cold depending on the condition of the flowing refrigerant. If you touch the pipes, burns or frostbite may result.
- After stopping operation, be sure to wait at least five minutes before turning off the main power switch. Otherwise, water leakage or breakdown may result.

1.5. Using R32 refrigerant outdoor units

⚠ Caution:

- Do not use refrigerant other than R32 refrigerant. If another refrigerant is used, the chlorine will cause the oil to deteriorate.
- Use the following tools specifically designed for use with R32 refrigerant. The following tools are necessary to use R32 refrigerant. Contact your nearest dealer for any questions.

Tools (for R32)	
Gauge manifold	Size adjustment gauge
Charge hose	Vacuum pump adapter
Gas leak detector	Electronic refrigerant charging scale
Torque wrench	

- Be sure to use the correct tools. If dust, debris, or moisture enters the refrigerant lines, refrigeration oil deterioration may result.

2. Installation location

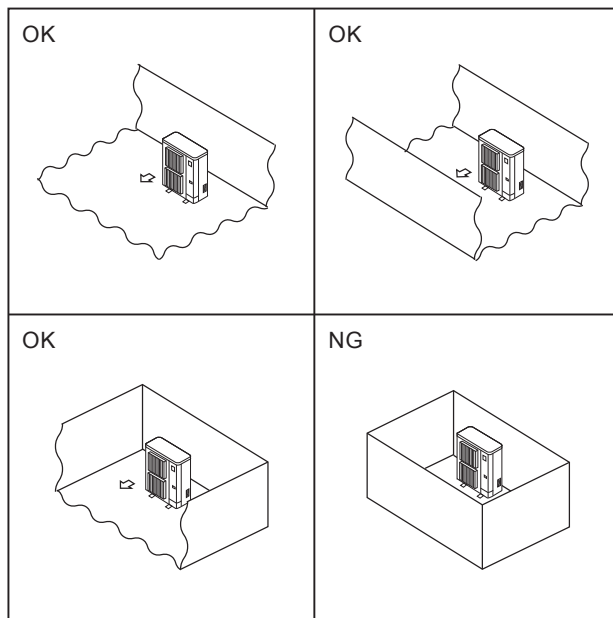

Fig. 2-1

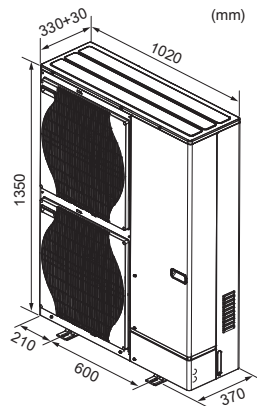

Fig. 2-2

2.1. Choosing the outdoor unit installation location

⊙ R32 is heavier than air—as well as other refrigerants—so tends to accumulate at the base (in the vicinity of the floor). If R32 accumulates around base, it may reach a flammable concentration in case room is small. To avoid ignition, maintaining a safe work environment is required by ensuring appropriate ventilation. If a refrigerant leak is confirmed in a room or an area where there is insufficient ventilation, refrain from using of flames until the work environment can be improved by ensuring appropriate ventilation.

- Avoid locations exposed to direct sunlight or other sources of heat.
 - Select a location from which noise emitted by the unit will not inconvenience neighbors.
 - Select a location permitting easy wiring and pipe access to the power source and indoor unit.
 - Avoid locations where combustible gases may leak, be produced, flow, or accumulate.
 - Note that water may drain from the unit during operation.
 - Select a level location that can bear the weight and vibration of the unit.
 - Avoid locations where the unit can be covered by snow. In areas where heavy snow fall is anticipated, special precautions such as raising the installation location or installing a hood on the air intake must be taken to prevent the snow from blocking the air intake or blowing directly against it. This can reduce the airflow and a malfunction may result.
 - Avoid locations exposed to oil, steam, or sulfuric gas.
 - Use the transportation handles of the outdoor unit to transport the unit. If the unit is carried from the bottom, hands or fingers may be pinched.
- ⊙ Install outdoor units in a place where at least one of the four sides is open, and in a sufficiently large space without depressions. (Fig. 2-1)

en

⚠ Caution:

- **Perform grounding.**
Do not connect the ground wire to a gas pipe, water pipe arrester or telephone ground wire. Defective grounding could cause an electric shock.
- **Do not install the unit in a place where an inflammable gas leaks.**
If gas leaks and accumulates in the area surrounding the unit, it could cause an explosion.
- **Install a ground leakage breaker depending on the installation place (where it is humid).**
If a ground leakage breaker is not installed, it could cause an electric shock.
- **Perform the drainage/piping work securely according to the installation manual.**
If there is a defect in the drainage/piping work, water could drop from the unit and household goods could be wet and damaged.

2.2. Outline dimensions (Outdoor unit) (Fig. 2-2)

2. Installation location

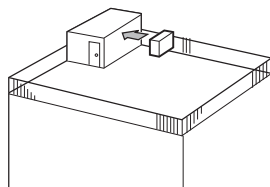

Fig. 2-3

2.3. Ventilation and service space

2.3.1. Windy location installation

When installing the outdoor unit on a rooftop or other location unprotected from the wind, situate the air outlet of the unit so that it is not directly exposed to strong winds. Strong wind entering the air outlet may impede the normal airflow and a malfunction may result.

The following shows three examples of precautions against strong winds.

- ① Face the air outlet towards the nearest available wall about 35 cm away from the wall. (Fig. 2-3)
- ② Install an optional air protect guide if the unit is installed in a location where strong winds from a typhoon, etc. may directly enter the air outlet. (Fig. 2-4)
 - Ⓐ Air protect guide
- ③ Position the unit so that the air outlet blows perpendicularly to the seasonal wind direction, if possible. (Fig. 2-5)
 - Ⓑ Wind direction

en

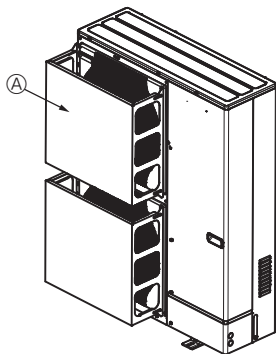

Fig. 2-4

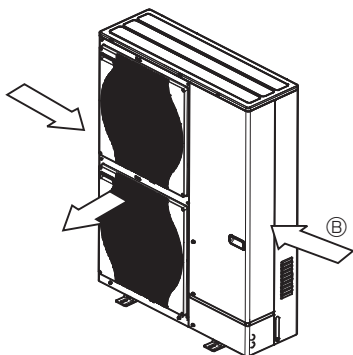

Fig. 2-5

2. Installation location

2.3.2. When installing a single outdoor unit

Minimum dimensions are as follows, except for Max., meaning Maximum dimensions, indicated.

Refer to the figures for each case.

- ① Obstacles at rear only (Fig. 2-6)
- ② Obstacles at rear and above only (Fig. 2-7)
 - Do not install the optional air outlet guides for upward airflow.
- ③ Obstacles at rear and sides only (Fig. 2-8)
- ④ Obstacles at front only (Fig. 2-9)
- ⑤ Obstacles at front and rear only (Fig. 2-10)
- ⑥ Obstacles at rear, sides, and above only (Fig. 2-11)
 - Do not install the optional air outlet guides for upward airflow.

2.3.3. When installing multiple outdoor units

Leave 50 mm space or more between the units.

Refer to the figures for each case.

- ① Obstacles at rear only (Fig. 2-12)
- ② Obstacles at rear and above only (Fig. 2-13)
 - No more than 3 units must be installed side by side. In addition, leave space as shown.
 - Do not install the optional air outlet guides for upward airflow.
- ③ Obstacles at front only (Fig. 2-14)
- ④ Obstacles at front and rear only (Fig. 2-15)
- ⑤ Single parallel unit arrangement (Fig. 2-16)
 - When using an optional air outlet guide installed for upward airflow, the clearance is 500 mm or more.
- ⑥ Multiple parallel unit arrangement (Fig. 2-17)
 - When using an optional air outlet guide installed for upward airflow, the clearance is 1000 mm or more.
- ⑦ Stacked unit arrangement (Fig. 2-18)
 - The units can be stacked up to two units high.
 - No more than 2 stacked units must be installed side by side. In addition, leave space as shown.

en

UNIT : mm

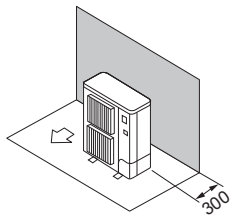

Fig. 2-6

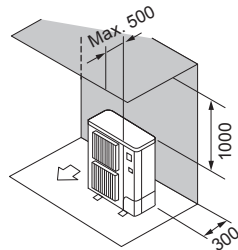

Fig. 2-7

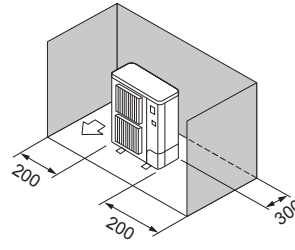

Fig. 2-8

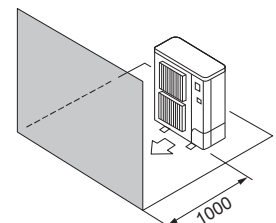

Fig. 2-9

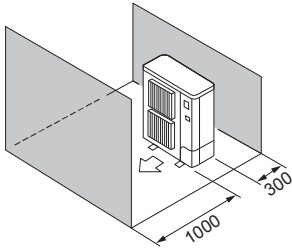

Fig. 2-10

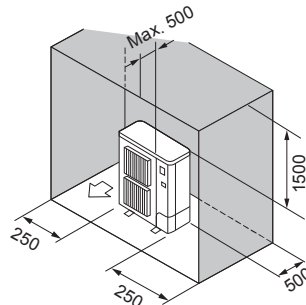

Fig. 2-11

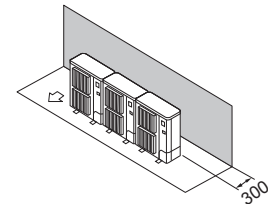

Fig. 2-12

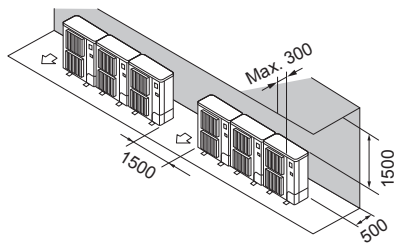

Fig. 2-13

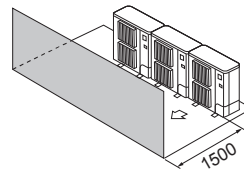

Fig. 2-14

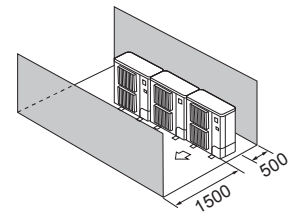

Fig. 2-15

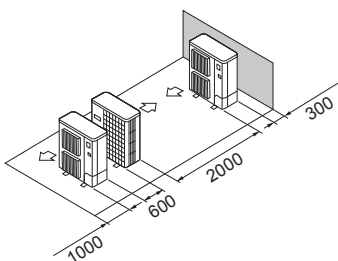

Fig. 2-16

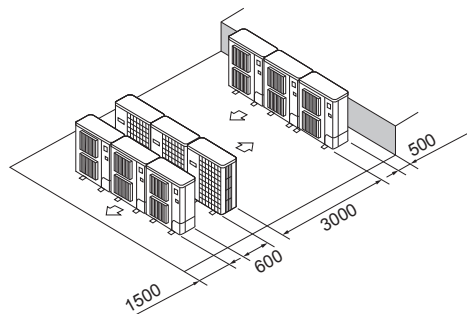

Fig. 2-17

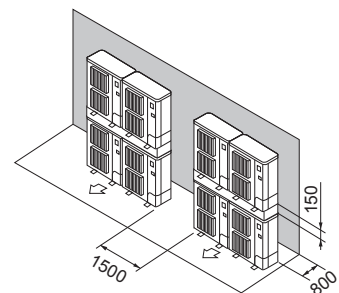

Fig. 2-18

2. Installation location

© 2.4. Minimum installation area

If you unavoidably install a unit in a space where all four sides are blocked or there are depressions, confirm that one of these situations (A, B or C) is satisfied.

Note: These countermeasures are for keeping safety not for specification guarantee.

A) Secure sufficient installation space (minimum installation area A_{min}).

Install in a space with an installation area of A_{min} or more, corresponding to refrigerant quantity M (factory-charged refrigerant + locally added refrigerant).

M [kg]	A_{min} [m ²]
1.0	12
1.5	17
2.0	23
2.5	28
3.0	34
3.5	39
4.0	45
4.5	50
5.0	56
5.5	62
6.0	67
6.5	73
7.0	78
7.5	84

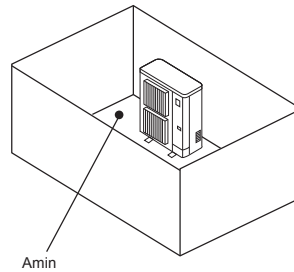

B) Install in a space with a depression height of ≤ 0.125 [m].

Height from the bottom of 0.125 [m] or less

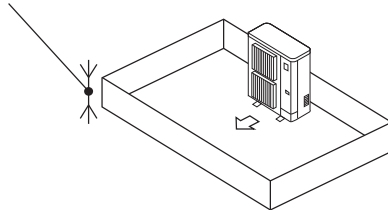

Height from the bottom of 0.125 [m] or less

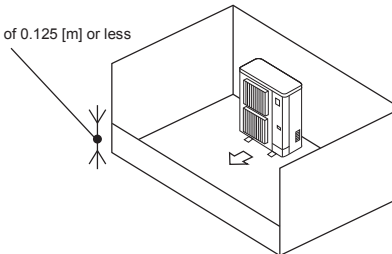

C) Create an appropriate ventilation open area.

Make sure that the width of the open area is 0.9 [m] or more and the height of the open area is 0.15 [m] or more.

However, the height from the bottom of the installation space to the bottom edge of the open area should be 0.125 [m] or less.

Open area should be 75% or more opening.

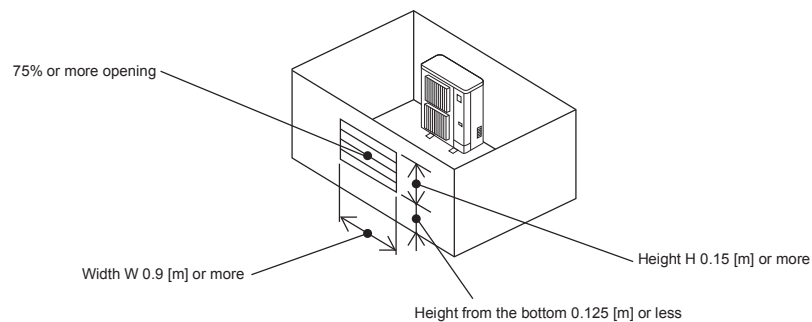

3. Installing the outdoor unit

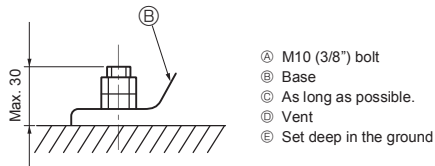
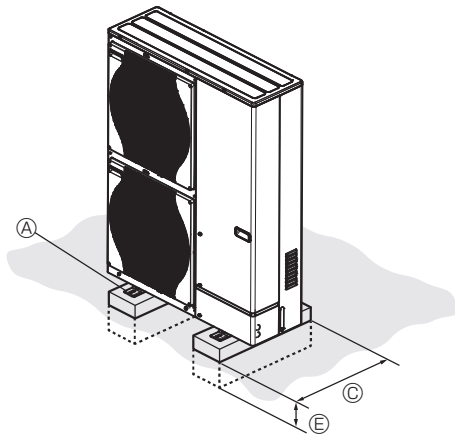

- Ⓐ M10 (3/8") bolt
- Ⓑ Base
- Ⓒ As long as possible.
- Ⓓ Vent
- Ⓔ Set deep in the ground

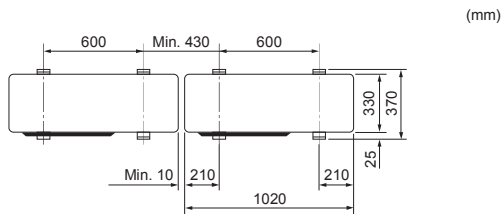
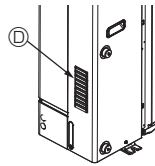

Fig. 3-1

- Be sure to install the unit in a sturdy, level surface to prevent rattling noises during operation. (Fig. 3-1)

<Foundation specifications>

Foundation bolt	M10 (3/8")
Thickness of concrete	120 mm
Length of bolt	70 mm
Weight-bearing capacity	320 kg

- Make sure that the length of the foundation bolt is within 30 mm of the bottom surface of the base.
- Secure the base of the unit firmly with four-M10 foundation bolts in sturdy locations.

Installing the outdoor unit

- Do not block the vent. If the vent is blocked, operation will be hindered and breakdown may result.
- In addition to the unit base, use the installation holes on the back of the unit to attach wires, etc., if necessary to install the unit. Use self-tapping screws (ø5 × 15 mm or less) and install on site.

⚠ Warning:

- **The unit must be securely installed on a structure that can sustain its weight. If the unit is mounted on an unstable structure, it may fall down and cause damage or injuries.**
- **The unit must be installed according to the instructions in order to minimize the risk of damage from earthquakes, typhoons, or strong winds. An incorrectly installed unit may fall down and cause damage or injuries.**

⚠ Caution:

- **Install the unit on a rigid structure to prevent excessive operation sound or vibration.**

en

4. Water piping work

4.1. Water piping connection (Fig. 4-1)

- Connect the water pipes to the outlet and inlet pipes.
(Parallel male screw for 1-inch water pipe (ISO 228/1-G1B))
- Inlet and outlet pipes position is shown on the Fig. 4-1.
- Install the hydraulic filter at the water intake.
- Maximum allowable torque at the water piping connection is 50 N·m.
- Check if water leaks after installation.
- Inlet water gauge pressure must be between 0-0.3 MPa.
- Use the inlet water with a temperature lower than 55 °C.

Note:

Refer to the indoor unit installation manual.

- **The water velocity in pipes should be kept within certain limits of material to avoid erosion, corrosion and excessive noise generation. Be aware, and take care of, that local velocities in small pipes, bends and similar obstructions can exceed the values above.**
- **When connecting metal pipes made of different materials, be sure to insulate the joint to prevent electrolytic etching.**
- **Set up a field system so that the inlet water temperature and water flow rate can be within the allowable range specified in our technical data, etc. If the unit is used out of the allowable range, the parts of unit might be damaged.**

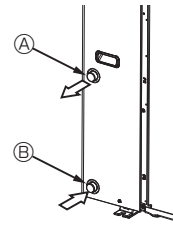

Fig. 4-1

Note:

Make sure to perform the frozen prevention measure for water pipe system. (Water piping insulation, back-up pump system, using of a certain % ethylene glycol instead of normal water)
Insulate the water piping properly. The performance can be poor if the insulation is insufficient.

Warning:

As the outlet water temperature can reach 60 °C at maximum, do not touch the water piping directly with a bare hand.

4.2. Water quality condition

- The water in a system should be clean and with a pH value of 6.5-8.0.
- The followings are the maximum values;
 - Calcium : 100 mg/L
 - Chlorine : 100 mg/L
 - Ca hardness : 250 mg/L
 - Copper : 0.3 mg/L

[Fig. 4-1]

- Ⓐ Water outlet
- Ⓑ Water inlet

4.3. Minimum water quantity

Refer to the indoor unit installation manual.

4.4. Parts which require regular inspection (Fig. 4-2)

Parts	Check every	Possible failures
Pressure relief valve (3 bar)	1 year (pushing the lever manually)	PRV would be fixed and expansion vessel would burst

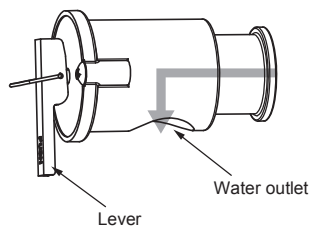

Fig. 4-2

Caution:

- Operate the lever when the water temperature falls below 40°C.
- Check that the water outlet of the pressure relief valve is facing downward before operating the lever.
If it is not facing downward, rotate the PRV so that it is facing downward.

4. Water piping work

4.5. Available range (Water flow rate, return water temp.)

■ Heating

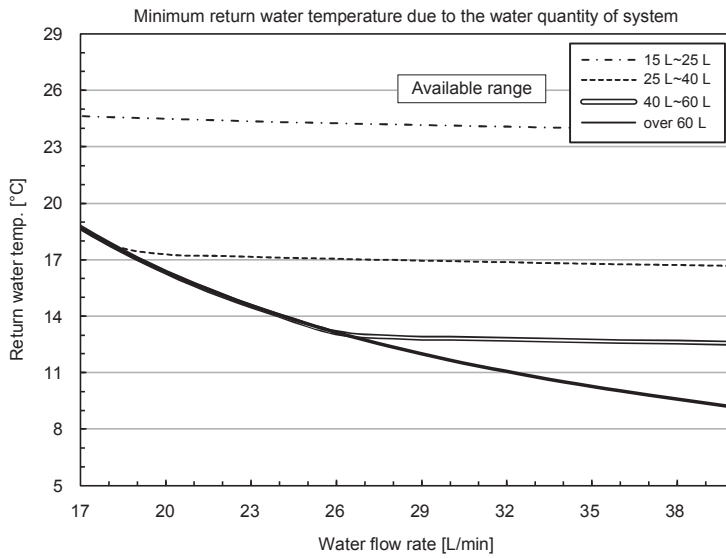

■ Cooling

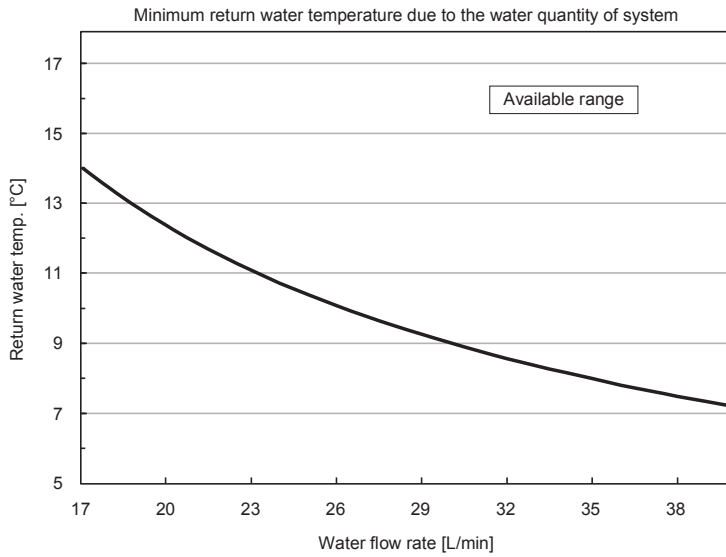

Note:

Be sure to avoid the unavailable range during defrosting.

Otherwise, the outdoor unit is insufficiently defrosted and/or the heat exchanger of the indoor unit may freeze.

en

5. Electrical work

5.1. Outdoor unit (Fig. 5-1, Fig. 5-2)

- ① Remove the service panel.
- ② Wire the cables referring to the Fig. 5-1 and the Fig. 5-2.

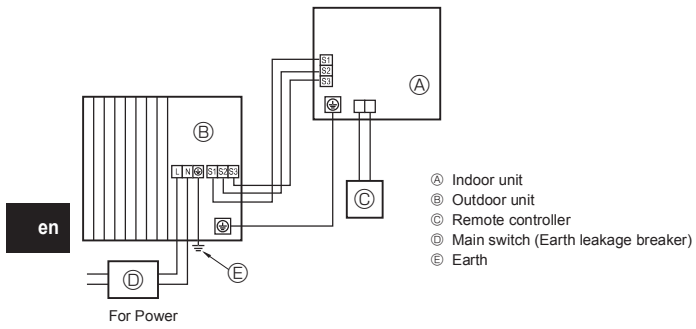

Fig. 5-1

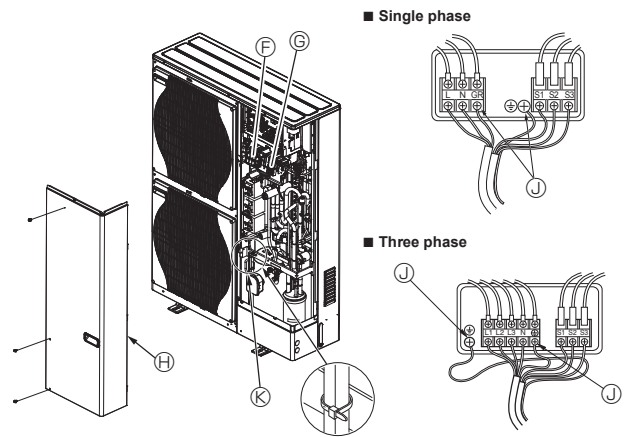

Fig. 5-2

- F Terminal block
 G Indoor/Outdoor connection terminal block (S1, S2, S3)
 H Service panel
 J Earth terminal
 K Clamp
 * Clamp the cables so that they do not contact the center of the service panel.

Note :

If the protective sheet for the electrical box is removed during servicing, be sure to reinstall it.

⚠ Caution:

Be sure to install N-Line. Without N-Line, it could cause damage to unit.

5. Electrical work

5.2. Field electrical wiring

Outdoor unit model		HWM140V	HWM140Y
Outdoor unit power supply		~N (single), 50 Hz, 230 V	3N~ (3 ph 4-wires), 50 Hz, 400 V
Outdoor unit input capacity Main switch (Breaker)		*1 40 A	16 A
Wiring Wire No. x size (mm ²)	Outdoor unit power supply	3 x Min. 6	5 x Min. 1.5
	Indoor unit-Outdoor unit	*2 3 x 1.5 (Polar)	3 x 1.5 (Polar)
	Indoor unit-Outdoor unit earth	*2 1 x Min. 1.5	1 x Min. 1.5
	Remote controller-Indoor unit	*3 2 x 0.3 (Non-polar)	2 x 0.3 (Non-polar)
Circuit rating	Outdoor unit L-N (single)	*4 230 VAC	230 VAC
	Outdoor unit L1-N, L2-N, L3-N (3 phase)	*4 230 VAC	230 VAC
	Indoor unit-Outdoor unit S1-S2	*4 24 VDC	24 VDC
	Indoor unit-Outdoor unit S2-S3	*4 12 VDC	12 VDC

*1. A breaker with at least 3.0 mm contact separation in each poles shall be provided. Use earth leakage breaker (NV).

Make sure that the current leakage breaker is one compatible with higher harmonics.

Always use a current leakage breaker that is compatible with higher harmonics as this unit is equipped with an inverter.

The use of an inadequate breaker can cause the incorrect operation of inverter.

*2. Max. 45 m

If 2.5 mm² used, Max. 50 m

If 2.5 mm² used and S3 separated, Max. 80 m

*3. The 10 m wire is attached in the remote controller accessory.

*4. The figures are NOT always against the ground.

S3 terminal has 24 VDC against S2 terminal. However between S3 and S1, these terminals are NOT electrically insulated by the transformer or other device.

*5. In multi-phase appliances, the colour of the neutral conductor of the supply cord, if any, shall be blue.

Notes: 1. Wiring size must comply with the applicable local and national codes.

2. Power supply cables and the cables between interface unit/Flow temp. controller and outdoor unit shall not be lighter than polychloroprene sheathed flexible cables. (Design 60245 IEC 57)

3. Be sure to connect the cables between interface unit/Flow temp. controller and outdoor unit directly to the units (no intermediate connections are allowed).

Intermediate connections may result in communication errors. If water enters at the intermediate connection point, it may cause insufficient insulation to ground or a poor electrical contact.

(If an intermediate connection is necessary, be sure to take measures to prevent water from entering the cables.)

4. Install an earth longer than other cables.

5. Do not construct a system with a power supply that is turned ON and OFF frequently.

6. Use self-extinguishing distribution cables for power supply wiring.

7. Properly route wiring so as not to contact the sheet metal edge or a screw tip.

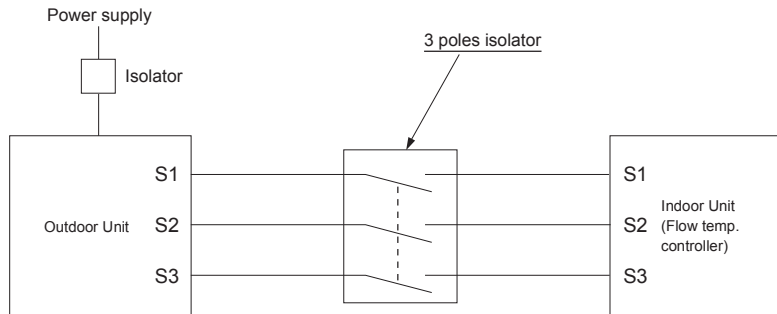

⚠ Warning:

- In case of A-control wiring, there is high voltage potential on the S3 terminal caused by electrical circuit design that has no electrical insulation between power line and communication signal line. Therefore, please turn off the main power supply when servicing. And do not touch the S1, S2, S3 terminals when the power is energized. If isolator should be used between indoor unit and outdoor unit, please use 3-pole type.







Never splice the power cable or the indoor-outdoor connection cable, otherwise it may result in a smoke, a fire or communication failure.

en

6. System control

Set the refrigerant address using the DIP switch of the outdoor unit.

SW1 Function Setting

SW1 Setting	Refrigerant address	SW1 Setting	Refrigerant address
ON OFF  3 4 5 6 7	00	ON OFF  3 4 5 6 7	03
ON OFF  3 4 5 6 7	01	ON OFF  3 4 5 6 7	04
ON OFF  3 4 5 6 7	02	ON OFF  3 4 5 6 7	05

Note:

a) Up to 6 units can be connected.

b) Select one single model for all units.

c) For Dip switch setting for indoor unit, refer to the indoor unit's installation manual.

en

7. Specifications

Outdoor model		PUZ-HWM140VHA	PUZ-HWM140YHA
Power supply	V / Phase / Hz	230 / Single / 50	400 / Three / 50
Dimensions (W × H × D)	mm	1020 × 1350 × 330	
Sound Power Level *1 (Heating)	dB(A)	67	

*1 Measured under rated operation frequency.

8. Serial number

■ The serial number is indicated on the SPEC NAME PLATE.

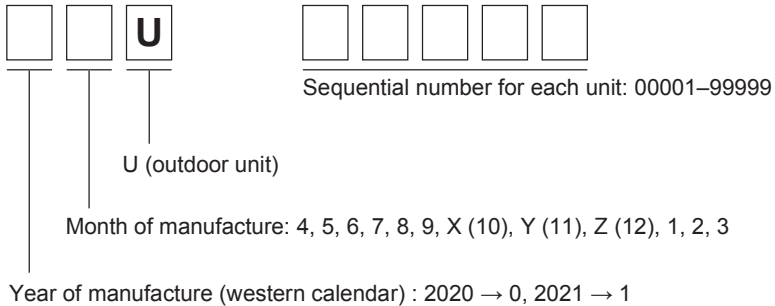

EC DECLARATION OF CONFORMITY
EG-KONFORMITÄTSEKHLÄRUNG
DECLARATION DE CONFORMITÉ CE
EG-CONFORMITEITSVERKLARING
DECLARACIÓN DE CONFORMIDAD CE
DICHIARAZIONE DI CONFORMITÀ CE

ΔΗΛΩΣΗ ΠΙΣΤΟΤΗΤΑΣ EK
DECLARAÇÃO DE CONFORMIDADE CE
EU-OVERENSSTEMMELSESEKHLÆRING
EG-DEKLARATION OM ÖVERENSSTÄMMELSE
CE-ERKLÆRING OM SAMSVAR
EY-VAATIMUSTENMUKAISUUSVAKUUTUS

ES PROHLÁŠENÍ O SHODĚ
DEKLARACJA ZGODNOŚCI WE
ЕС ДЕКЛАРАЦИЯ ЗА СЪОТВЕТСТВИЕ
VYHLÁŠENIE O ZHODE ES
EK MEGFELELŐSÉGI NYILATKOZAT
IZJAVA O SKLADNOSTI ES

DECLARAȚIE DE CONFORMITATE CE
EU VASTAVUSDEKLARATSIOON
EK ATBILSTĪBAS DEKLARĀCIJA
EB ATITIKTĪES DEKLARĀCIJA
EC IZJAVA O SUKLADNOSTI
EZ IZJAVA O USAGLAŠENOSTI

MITSUBISHI ELECTRIC CORPORATION
TOKYO BUILDING, 2-7-3, MARUNOUCHI, CHIYODA-KU, TOKYO 100-8310, JAPAN

hereby declares under its sole responsibility that the air conditioners and heat pumps described below for use in residential, commercial and light-industrial environments:
erklärt hiermit auf seine alleinige Verantwortung, dass die Klimaanlage und Wärmepumpen für das häusliche, kommerzielle und leicht-industrielle Umfeld wie unten beschrieben:
déclare par la présente et sous sa propre responsabilité que les climatiseurs et les pompes à chaleur décrits ci-dessous, destinés à un usage dans des environnements résidentiels, commerciaux et d'industrie légère :

verklaart hierbij onder eigen verantwoordelijkheid dat de voor residentiële, commerciële en licht-industriële omgevingen bestemde airconditioners en warmtepompen zoals onderstaand beschreven:
por la presente declara bajo su única responsabilidad que los acondicionadores de aire y bombas de calor descritas a continuación para su uso en entornos residenciales, comerciales y de industria ligera:
confirma con la presente, sotto la sua esclusiva responsabilità, che i condizionatori d'aria e le pompe di calore descritti di seguito e destinati all'utilizzo in ambienti residenziali, commerciali e semi-industriali:
με το παρόν πιστοποιεί με αποκλειστική της ευθύνη ότι οι τα κλιματιστικά και οι αντλίες θέρμανσης που περιγράφονται παρακάτω για χρήση σε οικιακό, επαγγελματικό και ελαφριάς βιομηχανίας περιβάλλοντα:

através da presente declara sob sua única responsabilidade que os aparelhos de ar condicionado e bombas de calor abaixo descritos para uso residencial, comercial e de indústria ligeira:
erklærer hermed under eneansvar, at de herunder beskrevne airconditionanlæg og varmepumper til brug i privat boligbyggeri, erhvervsområder og inden for let industri:
intygar härmed att luftkonditioneringarna och värmepumparna som beskrivs nedan för användning i bostäder, kommersiella miljöer och lätta industriella miljöer:
erklærer et fullstendig ansvar for undernevnte klimaanlegg og varmepumper ved bruk i boliger, samt kommersielle og lettindustrielle miljøer:
vakuuttaa täten yksinomaissella vastuullaan, että jäljempänä kuvatut asuinrakennuksiin, pientaloihin ja kaupalliseen käyttöön tarkoitettuihin ulkoilma- ja lämpöpumpat:
tímto na vlastní odpovědnost prohlašuje, že níže popsané klimatizační jednotky a tepelné čerpadla pro použití v obytných prostředích, komerčních prostředích a prostředích lehkého průmyslu:
niniejszym oświadczam na swoją wyłączną odpowiedzialność, że klimatyzatory i pompy ciepła opisane poniżej, są przeznaczone do zastosowań w środowisku mieszkalnym, handlowym i lekko przemysłowym:
декларира на своя собствена отговорност, че климатичните и термopомпите, описани по-долу, за употреба в жилищни, търговски и леки промишлени условия:
týmto na svoju výlučnú zodpovednosť vyhlasuje, že nasledovné klimatizačné jednotky a tepelné čerpadlá určené na používanie v obytných a obchodných priestoroch a v prostredí ľahkého priemyslu:
alulírott kizárólagos felelősségére nyilatkozik, hogy az alábbi lakossági, kereskedelmi és kisipari környezetben való használatra szánt klímaberendezések és hőszivattyúk:
izjavlja pod izključno lastno odgovornostjo, da so spodaj navedene klimatske naprave in toplotne črpalke, namenjene uporabi v stanovanjskih, komercialnih in lahkoindustrijskih okoljih:
declară, prin prezenta, pe proprie răspundere, faptul că aparatele de climatizare și pompele de căldură descrise mai jos și destinate utilizării în medii rezidențiale, comerciale și din industria ușoară:
kinnitab käesolevaga oma ainuvastutusele, et allpool toodud kliimaseadmed ja sooajuspumbad on mõeldud kasutamiseks elu-, äri- ja kergtööstuskeskkondades:
ar šo, vienpersoniski uzņemoties atbildību, paziņo, ka tālāk aprakstītie gaisa kondicionētāji un siltumsūkņi ir paredzēti lietošanai dzīvojamajās, komercdarbības un vieglās rūpniecības telpās.
šiuo vien tik savo atsakomybe pareiški, kad toliau apibūdinti oro kondicionieriai ir šilumos siurbiai skirti naudoti gyvenamosiose, komercinėse ir lengvosios pramonės aplinkose:
ovime izjavljuje pod izključivom odgovornostjo da su klimatizacijski uređaji i toplinske dizalice opisane u nastavku namijenjeni za upotrebu u stambenim i poslovnim okruženjima lake industrije:
ovim izjavljuje na svoju isključivu odgovornost da su klima-uređaji i toplotne pumpe opisane u daljem tekstu za upotrebu u stambenim, komercijalnim okruženjima i okruženjima sa lakom industrijom:

MITSUBISHI ELECTRIC, PUZ-HWM140VHA*, PUZ-HWM140YHA*

Note: Its serial number is on the nameplate of the product.
Hinweis: Die Seriennummer befindet sich auf dem Kennschild des Produkts.
Remarque : Le numéro de série de l'appareil se trouve sur la plaque du produit.
Opmerking : het serienummer staat op het naamplaatje van het product.
Nota: El número de serie se encuentra en la placa que contiene el nombre del producto.
Nota: il numero di serie si trova sulla targhetta del prodotto.
Σημείωση: Ο σειριακός του αριθμός βρίσκεται στην πινακίδα ονόματος του προϊόντος.
Nota: o número de série encontra-se na placa que contém o nome do produto.
Bemærk: Seriennummeret står på produktets fabriksskilt.
Obs: Serienumret finns på produktens namnplåt.
Merk: Seriennummeret befinner seg på navneplaten til produktet.
Huomautus: Sarjanumero on merkitty laitteen arvokilpeen.

Poznámka: Příslušné sériové číslo se nachází na štítku produktu.
Uwaga: Numer seryjny znajduje się na tabliczce znamionowej produktu.
Забелешка: Серијният номер е на табелката на продукта.
Poznámka: Výrobné číslo sa nachádza na typovom štítku výrobku.
Megjegyzés: A sorozatszám a termék adattábláján található.
Opomba: serijska številka je zapisana na tipski ploščici enote.
Notă: Numărul de serie este specificat pe plăcuța indicatoare a produsului.
Márkus. Seerianumber asub toote andmesilidil.
Piezīme. Sērijas numurs ir norādīts uz ierīces datu plāksnītes.
Pastaba. Serijos numeris nurodytas gaminio vardinii duomenų lentelėje.
Napomena: serijski broj nalazi se na natpisnoj pločici proizvoda.
Napomena: Serijski broj nalazi se na nazivnoj pločici proizvoda.

Directives
Richtlijnen
Directives
Richtlijnen
Directivas
Direttive

Οδηγίες
Directivas
Direktiver
Direktiv
Direktiver
Direktiivit

Směrnice
Dyrektywy
Директиви
Smernice
Írányelvek
Direktive

Directive
Direktiivid
Direktivas
Direktivos
Direktive
Direktive

2014/35/EU: Low Voltage Directive
2006/42/EC: Machinery Directive
2014/30/EU: Electromagnetic Compatibility Directive
2009/125/EC: Energy-related Products Directive and Regulation (EU) No. 813/2013
2011/65/EU, (EU) 2015/863 and (EU) 2017/2102: RoHS Directive
2014/68/EU: Pressure Equipment Directive

Issued: 1 April 2020
JAPAN

Tomoyuki Miwa
Manager, Quality Assurance Department

<ENGLISH>

English is original. The other languages versions are translation of the original.

⚠ CAUTION

- Refrigerant leakage may cause suffocation. Provide ventilation in accordance with EN378-1.
- Be sure to wrap insulation around the piping. Direct contact with the bare piping may result in burns or frostbite.
- Never put batteries in your mouth for any reason to avoid accidental ingestion.
- Battery ingestion may cause choking and/or poisoning.
- Install the unit on a rigid structure to prevent excessive operation sound or vibration.
- The A-weighted sound pressure level is below 70dB.
- This appliance is intended to be used by expert or trained users in shops, in light industry and on farms, or for commercial use by lay persons.

<DEUTSCH>

Das Original ist in Englisch. Die anderen Sprachversionen sind vom Original übersetzt.

⚠ VORSICHT

- Wenn Kältemittel austritt, kann dies zu Ersticken führen. Sorgen Sie in Übereinstimmung mit EN378-1 für Durchlüftung.
- Die Leitungen müssen isoliert werden. Direkter Kontakt mit nicht isolierten Leitungen kann zu Verbrennungen oder Erfrierungen führen.
- Nehmen Sie niemals Batterien in den Mund, um ein versehentliches Verschlucken zu vermeiden.
- Durch das Verschlucken von Batterien kann es zu Ersticken und/oder Vergiftungen kommen.
- Installieren Sie das Gerät auf einem stabilen Untergrund, um übermäßige Betriebsgeräusche oder -schwingungen zu vermeiden.
- Der A-gewichtete Schalldruckpegel ist niedriger als 70dB.
- Dieses Gerät ist vorgesehen für die Nutzung durch Fachleute oder geschultes Personal in Werkstätten, in der Leichtindustrie und in landwirtschaftlichen Betrieben oder für die kommerzielle Nutzung durch Laien.

<FRANÇAIS>

L'anglais est l'original. Les versions fournies dans d'autres langues sont des traductions de l'original.

⚠ PRECAUTION

- Une fuite de réfrigérant peut entraîner une asphyxie. Fournissez une ventilation adéquate en accord avec la norme EN378-1.
- Assurez-vous que la tuyauterie est enveloppée d'isolant. Un contact direct avec la tuyauterie nue peut entraîner des brûlures ou des engelures.
- Ne mettez jamais des piles dans la bouche pour quelque raison que ce soit pour éviter de les avaler par accident.
- Le fait d'ingérer des piles peut entraîner un étouffement et/ou un empoisonnement.
- Installez l'appareil sur une structure rigide pour prévenir un bruit de fonctionnement et une vibration excessifs.
- Le niveau de pression acoustique pondéré est en dessous de 70 dB.
- Cet appareil est conçu pour un utilisateur expert ou les utilisateurs formés en magasin, dans l'industrie légère et dans l'agriculture ou dans le commerce par le profane.

<NEDERLANDS>

Het Engels is het origineel. De andere taalversies zijn vertalingen van het origineel.

⚠ VOORZICHTIG

- Het lekken van koelvlloeistof kan verstikking veroorzaken. Zorg voor ventilatie in overeenstemming met EN378-1.
- Isoleer de leidingen met isolatiemateriaal. Direct contact met de onbedekte leidingen kan leiden tot brandwonden of bevriezing.
- Stop nooit batterijen in uw mond om inslikking te voorkomen.
- Het inslikken van batterijen kan verstikking of vergiftiging veroorzaken.
- Installeer het apparaat op een stabiele structuur om overmatig lawaai of trillingen te voorkomen.
- Het niveau van de geluidsdruk ligt onder 70 dB(A).
- Dit apparaat is bedoeld voor gebruik door ervaren of opgeleide gebruikers in werkplaatsen, in de lichte industrie en op boerderijen, of voor commercieel gebruik door leken.

<ESPAÑOL>

El idioma original del documento es el inglés. Las versiones en los demás idiomas son traducciones del original.

⚠ CUIDADO

- Las pérdidas de refrigerante pueden causar asfixia. Se debe proporcionar la ventilación determinada en EN378-1.
- Asegúrese de colocar el aislante alrededor de las tuberías. El contacto directo con la tubería puede ocasionar quemaduras o congelación.
- Para evitar una ingestión accidental, no coloque las pilas en su boca bajo ningún concepto.
- La ingestión de las pilas puede causar asfixia y/o envenenamiento.
- Coloque la unidad en una estructura rígida para evitar que se produzcan sonidos o vibraciones excesivos debidos a su funcionamiento.
- El nivel de presión acústica ponderado A es inferior a 70 dB.
- Este aparato está destinado a su uso por parte de usuarios expertos o capacitados en talleres, industrias ligeras y granjas, o a su uso comercial por parte de personas no expertas.

<ITALIANO>

Il testo originale è redatto in lingua Inglese. Le altre versioni linguistiche rappresentano traduzioni dell'originale.

⚠ ATTENZIONE

- Le perdite di refrigerante possono causare asfissia. Prevedere una ventilazione adeguata in conformità con la norma EN378-1.
- Accertarsi di applicare materiale isolante intorno alle tubature. Il contatto diretto con le tubature non schermate può provocare ustioni o congelamento.
- Non introdurre in nessun caso le batterie in bocca onde evitare ingestioni accidentali.
- L'ingestione delle batterie può provocare soffocamento e/o avvelenamento.
- Installare l'unità su una struttura rigida in modo da evitare rumore o vibrazioni eccessivi durante il funzionamento.
- Il livello di pressione del suono ponderato A è inferiore a 70dB.
- Questa apparecchiatura è destinata all'utilizzo da parte di utenti esperti o addestrati in negozi, industria leggera o fattorie oppure a un uso commerciale da parte di persone non esperte.

<ΕΛΛΗΝΙΚΑ>

Η γλώσσα του πρωτοτύπου είναι η αγγλική. Οι εκδόσεις άλλων γλωσσών είναι μεταφράσεις του πρωτοτύπου.

⚠ ΠΡΟΣΟΧΗ

- Η διαρροή του ψυκτικού ενδέχεται να προκαλέσει ασφυξία. Φροντίστε για τον εξαερισμό σύμφωνα με το πρότυπο EN378-1.
- Φροντίστε να τυλιχτείτε με μονωτικό υλικό τη σωλήνωση. Η απευθείας επαφή με τη γυμνή σωλήνωση ενδέχεται να προκαλέσει εγκαύματα ή κρυοπαγήματα.
- Μη βάζετε ποτέ τις μπαταρίες στο στόμα σας για κανένα λόγο ώστε να αποφύγετε την κατά λάθος κατάποσή τους.
- Η κατάποση μπαταριών μπορεί να προκαλέσει πνιγμό ή/και δηλητηρίαση.
- Εγκαταστήστε τη μονάδα σε σταθερή κατασκευή ώστε να αποφύγετε τον έντονο ήχο λειτουργίας ή τους κραδασμούς.
- Η Α-σταθμισμένη στάθμη ηχητικής πίεσης είναι κάτω των 70dB.
- Η συσκευή αυτή προορίζεται για χρήση από έμπειρους ή εκπαιδευμένους χρήστες σε καταστήματα, στην ελαφριά βιομηχανία και σε αγροκτήματα, ή για εμπορική χρήση από άτομα τα οποία δεν είναι ειδήμονες.

<PORTUGUÊS>

O idioma original é o inglês. As versões em outros idiomas são traduções do idioma original.

⚠ CUIDADO

- A fuga de refrigerante pode causar asfixia. Garanta a ventilação em conformidade com a norma EN378-1.
- Certifique-se de que envolve as tubagens com material de isolamento. O contacto directo com tubagens não isoladas pode resultar em queimaduras ou ulcerações provocadas pelo frio.
- Nunca coloque pilhas na boca, por nenhum motivo, para evitar a ingestão accidental.
- A ingestão de uma pilha pode causar obstrução das vias respiratórias e/ou envenenamento.
- Instale a unidade numa estrutura robusta, de forma a evitar ruídos ou vibrações excessivos durante o funcionamento.
- O nível de pressão sonora ponderado A é inferior a 70 dB.
- Este equipamento destina-se a ser utilizado por especialistas ou utilizadores com formação em lojas, na indústria ligeira e em quintas, ou para utilização comercial por leigos.

<DANSK>

Engelsk er originalen. De andre sprogversioner er oversættelser af originalen.

⚠ FORSIGTIG

- Lækage af kølemiddel kan forårsage kvælning. Sørg for udluftning i overensstemmelse med EN378-1.
- Sørg for at pakke rørene ind i isolering. Direkte kontakt med ubeklædte rør kan forårsage forbrændinger eller forfrysninger.
- Batterier må under ingen omstændigheder tages i munden for at forhindre utilsigtet indtagelse.
- Indtagelse af batterier kan forårsage kvælning og/eller forgiftning.
- Installer enheden på en fast struktur for at forhindre for høje driftslyde eller vibrationer.
- Det A-vægtede lydtrykkniveau er under 70dB.
- Dette apparat er beregnet til at blive brugt af eksperter eller udlærte brugere i butikker, inden for let industri og på gårde eller til kommerciel anvendelse af lægmænd.

<SVENSKA>

Engelska är originalspråket. De övriga språkversionerna är översättningar av originalet.

⚠ FÖRSIKTIGHET

- Köldmedelsläckage kan leda till kvävning. Tillhandahåll ventilation i enlighet med EN378-1.
- Kom ihåg att linda isolering runt rören. Direktkontakt med bara rör kan leda till brännskador eller köldskador.
- Stoppa aldrig batterier i munnen, de kan sväljas av misstag.
- Om ett batteri sväljs kan det leda till kvävning och/eller förgiftning.
- Montera enheten på ett stadigt underlag för att förhindra höga driftljud och vibrationer.
- Den A-vägda ljudtrycksnivån är under 70dB.
- Denna apparat är ämnad för användning av experter eller utbildade användare i affärer, inom lätt industri och på lantbruk, eller för kommersiell användning av lekmän.

<NORSK>

Originalspråket er engelsk. De andre språkversjonene er oversettelser av originalen.

⚠ FORSIKTIG

- Kjølemedellekkasje kan forårsake kvælning. Sørg for ventilering i samsvar med EN378-1.
- Pass på at isoleringen pakkes godt rundt røret. Direkte kontakt med ukledte rør kan forårsake brannskader eller forfrysninger.
- Aldri plasser batteri i munnen, da dette kan medføre en risiko for at du svelger batteriet ved et uheld.
- Hvis du svelger et batteri, kan du risikere kvælning og/eller forgiftning.
- Installer enheten på en stabil struktur for å forhindre unødvendig mye driftsstøy eller vibrering.
- Det A-vektede lydtryknivået er under 70 dB.
- Dette apparatet er ment for bruk av eksperter eller faglært personell i butikker, lettindustri og på gårder, eller for kommersielt bruk av ikke-fagmenn.

<SUOMI>

Englanninkielinen asiakirja on alkuperäinen. Muunkieliset versiot ovat alkuperäisen käännöksiä.

⚠ HUOMIO

- Kylmäaineen vuoto voi aiheuttaa tukehtumisen. Järjestä tuuletus standardin EN378-1 mukaisesti.
- Pukittomia pitää eristää. Suora kosketus paljaaseen putkeen voi aiheuttaa palovamman tai pulttuman.
- Älä koskaan laita paristoja suuhun mistään syystä, jotta vältät tahattoman nielemisen.
- Pariston nieleminen voi aiheuttaa tukehtumisen ja/tai myrkytymisen.
- Asenna yksikkö tukevaan rakenteeseen estääksesi liiallisen, toiminnasta aiheutuvan, äänen tai värinän.
- A-painotettu äänenpainetaso on alle 70 dB.
- Tämä laite on tarkoitettu asiantuntijoiden tai koulutettujen käyttäjien käytettäväksi liikehuoneistoissa, kevyen teollisuuden tiloissa ja maataloilla tai maallikkujen kaupalliseen käyttöön.

<ČEŠTINA>

Originál je v angličtině. Ostatní jazykové verze jsou překladem originálu.

⚠ POZOR

- Únik chladicího média může způsobit udušení. Zajistěte větrání v souladu s normou EN 378-1.
- Potrubí omotejte izolací. Přímý kontakt s oznaženým potrubím může způsobit popálení nebo omrzliny.
- Nikdy si z žádného důvodu nevkládejte baterie do úst, aby nedošlo k jejich polknutí.
- Polknutí baterie může způsobit dušení anebo otravu.
- Jednotku nainstalujte na pevnou konstrukci, aby nedocházelo ke vzniku nadměrného provozního hluku a vibrací.
- Hladina akustického tlaku je nižší než 70 dB.
- Toto zařízení je určeno pro prodejny, lehký průmysl a farmy, kde je musí obsluhovat odborníci a školení uživatelé, a pro komerční použití, kde je mohou obsluhovat laici.

<POLSKI>

Językiem oryginalnym jest język angielski. Inne wersje językowe stanowią tłumaczenia oryginalne.

⚠ UWAGA

- Wyciek czynnika chłodniczego może spowodować uduszenie. Należy zapewnić wentylację zgodną z normą EN378-1.
- Należy pamiętać, aby owinać izolacją wokół przewodów rurowych. Bezpośredni kontakt z niezabezpieczonymi przewodami rurowymi może doprowadzić do poparzeń lub odmrożeń.
- Nie wolno wkładać baterii do ust z jakiegokolwiek powodu, aby uniknąć przypadkowego połknięcia.
- Połknięcie baterii może spowodować zadławienie i/lub zatrucie.
- Zainstalować urządzenie na sztywnej konstrukcji, aby zapobiec nadmiernemu hałasowi i wibracjom.
- Poziom dźwięku A nie przekracza 70 dB.
- W sklepach, w przemyśle lekkim i w gospodarstwach rolnych urządzenie powinni obsługiwać profesjonalni lub przeszkoleni użytkownicy, a w środowisku handlowym mogą to być osoby nieposiadające fachowej wiedzy.

<БЪЛГАРСКИ>

Оригиналът е текстът на английски език. Версиите на други езици са преводи на оригинала.

▲ ВНИМАНИЕ

- Истичането на хладилен агент може да причини задушаване. Осигурете вентилация съобразно с EN378-1.
- Не забравяйте да поставите изолация на тръбите. Директният контакт с оголени тръби може да причини изгаряне или измръзване.
- При никакви обстоятелства не поставяйте батериите в устата си, в противен случай може да ги погълнете случайно.
- Поглъщането на батериите може да доведе до задавяне и/или отравяне.
- Монтирайте тялото върху твърда конструкция, за да предотвратите прекомерен шум или вибрации по време на работа.
- A-претегленото ниво на звуково налягане е под 70 dB.
- Този уред е предназначен за използване от експерти или обучени потребители в магазини, в леката промишленост и във ферми, или за търговска употреба от неспециалисти.

<SLOVENČINA>

Preklad angleškého originálu. Všetky jazykové verzie sú preložené z angličtiny.

▲ UPOZORNENIE

- Únik chladiva môže spôsobiť udusenie. Zabezpečte vetranie podľa normy EN 378-1.
- Nezabudnite potrubie obaliť izoláciou. Priamy kontakt s nezabaleným potrubím môže spôsobiť popáleniny alebo omrzliny.
- Baterie si nikdy z akéhokoľvek dôvodu nekladte do úst, aby nedošlo k ich náhodnému požitiu.
- Požitie batérii môže vyvolať dusenie a/alebo otravu.
- Nainštalujte jednotku na pevný konštrukčný prvok, aby ste obmedzili nadmerný prevádzkový hluk a vibrácie.
- Hladina akustického tlaku vážená podľa krivky A je nižšia ako 70 dB.
- Toto zariadenie je určené na používanie odborníkmi alebo zaškolenými používateľmi v komerčných priestoroch, v prostredí ľahkého priemyslu, na farmách, alebo na komerčné použitie bežnými používateľmi.

<MAGYAR>

Az angol változat az eredeti. A többi nyelvi változat az eredeti fordítása.

▲ VIGYÁZAT

- A hűtőközeg szivárgása fulladást okozhat. Gondoskodjon az EN378-1 szabvány előírásai szerinti szellőzéstől.
- Feltétlenül szigetelje körbe a csöveket. A csupasaz cső megérintése égési vagy fagyási sérülést okozhat.
- Ne vegyen a szájába elemet semmilyen célból, mert véletlenül lenyelheti!
- A lenyelt elem fulladást és/vagy mérgezést okozhat.
- A készüléket merev szerkezetre szerelje fel, hogy megakadályozza a túlzott üzemi zajt és vibrációt.
- Az A-súlyozott hangnyomásszint 70 dB alatt van.
- A készülék üzemel, a könnyűipar és gazdaságok szakértő vagy képzett felhasználói, valamint laikus felhasználók általi kereskedelmi használatra készült.

<SLOVENŠČINA>

Izvirnik je v angleščini. Druge jezikovne različice so prevodi izvirnika.

▲ POZOR

- Puščanje hladiva lahko povzroči zaдушitev. Zagotovite prezračevanje po standardu EN378-1.
- Cevi ovijte z izolacijo. Neposredni stik z golimi cevimi lahko povzroči opekline ali ozebljine.
- Nikoli in iz nobenega razloga ne vstavljajte baterij v usta, da jih po nesreči ne pogoltnete.
- Če baterije pogoltnete, se lahko zaдушite in/ali zastrupite.
- Enoto namesite na togo konstrukcijo, da preprečite pretiran zvok ali tresljaje med delovanjem.
- A-utežena raven zvočnega tlaka je pod 70 dB.
- Naprava je namenjena za uporabo s strani strokovnih ali ustrezno usposobljenih uporabnikov v trgovinah, lahki industriji in na kmetijah ter za komercialno uporabo s strani nestrokovnih uporabnikov.

<ROMÂNĂ>

Textul original este în limba engleză. Versiunile pentru celelalte limbi sunt traduceri ale originalului.

▲ ATENȚIE

- Scurgerea de agent frigorific poate cauza asfixierea. Asigurați o ventilație corespunzătoare, conform standardului EN378-1.
- Asigurați-vă că înfășurați materialul izolator în jurul conductelor. Contactul direct cu conductele neizolate se poate solda cu arsuri sau degerături.
- Nu introduceți niciodată și pentru niciun motiv bateriile în gură, pentru a evita ingerarea accidentală a acestora.
- Ingerarea bateriilor poate cauza sufocarea și/sau intoxicarea.
- Instalați unitatea pe o structură rigidă pentru a preveni producerea unui nivel excesiv de sunete sau vibrații.
- Nivelul de presiune acustică ponderată în A este mai mic de 70 dB.
- Acest aparat este destinat utilizării de către utilizatori specializați sau instruiți în cadrul spațiilor comerciale, spațiilor din cadrul industriei ușoare și al fermelor sau în scopuri comerciale de către nespecialiști.

<EESTI>

Originaaljuhend on ingliskeelne. Muudes keeltes versioonid on originaali tõlked.

▲ ETTEVAATUST!

- Külmaaine leke võib põhjustada lämbumist. Tuulutamine standardi EN378-1 kohaselt.
- Mähkige torude ümber kindlasti isolatsiooni. Vahetu kontakt paljaste torudega võib põhjustada põletusi või külmakahjustusi.
- Hoiduge patareide tahtmatust allaneelamisest, ärge kunagi pange ühelgi põhjusel patareid suhu.
- Patarei allaneelamine võib põhjustada lämbumist ja/või mürgitust.
- Paigaldage seade jäigale struktuurile, et vältida ülemäärast tööheli ja vibreerimist.
- A-filtriga helirõhu tase on madalam kui 70 dB.
- Seade on mõeldud kasutamiseks asjatundjatele ja väljaõppe läbinud kasutajatele pooides, kergtööstuses ja taludes ning kommertskasutuseks tavaisikute poolt.

<LATVIŠKI>

Origināls ir angļu valodā. Versijas citās valodās ir oriģināla tulkojums.

▲ UZMANĪBU

- Aukstumaģenta noplūdes gadījumā pastāv nosmakšanas risks. Ir jānodrošina standartam EN378-1 atbilstoša ventilācija.
- Aptiniet caurules ar izolējošu materiālu. Pieskaroties neapftām caurulēm, var gūt apdegumus vai apsaldejumus.
- Aizliegts ievietot baterijas mutē; pastāv norišanas risks.
- Bateriju norišana var izraisīt aizrīšanas un/vai saindēšanas.
- Uzstādiet iekārtu uz izturīgas struktūras, lai izvairītos no pārlieku liela darbības trokšņa vai vibrācijas.
- A — izsvartarotais skaņas spiediena līmenis ir mazāks par 70 dB.
- Šo iekārtu paredzēts lietot speciālistiem vai apmācītiem lietotājiem veikalos, vieglās rūpniecības telpās un lauksaimniecības fermās, kā arī to var lietot nespeciālisti komerciālām vajadzībām.

<LIETUVIŠKAI>

Originalas yra anglų k. Versijos kitomis kalbomis yra originalo vertimas.

▲ ATSARGIAI

- Dėl šaltnešio nuotėkio galima uždusti. Išvėdinkite patalpą pagal EN378-1.
- Būtinai vamzdelius apvyniokite izoliacija. Prisilietus prie plikų vamzdelių galima nusideginti arba nušalti.
- Siekdami išvengti atsitiktinio prarijimo, niekada nedėkite baterijų į burną.
- Prarijus bateriją galima užspringti ir / arba apsinuodyti.
- Išrenginį sumontuokite ant tvirtos struktūros, kad nesigirdėtų pernelyg didelio veikimo triukšmo ar vibracijos.
- A svertinis garso slėgio lygis nesiekia 70 dB;
- Šis prietaisas skirtas naudoti specialistui ar išmokytiems naudotojams dirbtuvėse, lengvojoje pramonėje ar ūkiuose arba komerciniam naudojimui nespecialistams.

<HRVATSKI>

Tekst je izvorno napisan na engleskom jeziku. Tekst na ostalim jezicima predstavlja prijevod izvorno napisanog teksta.

▲ OPREZ

- Curenje rashladnog sredstva može uzrokovati gušenje. Osigurajte ventilaciju u skladu s normom HR EN378-1.
- Obavezno stavite izolaciju oko položenih cijevi. Izravni doticaj s golim cijevima može dovesti do opekлина ili smrzavanja.
- Nikada ne stavljajte baterije u usta ni zbog kojeg razloga kako biste izbjegli slučajno gutanje.
- Gutanje baterija može prouzročiti gušenje i/ili trovanje.
- Postavite jedinicu na čvrstu površinu kako biste izbjegli prebučan zvuk tijekom rada ili pojavu vibracija.
- Razina zvučnog tlaka A niža je od 70dB.
- Ovaj uređaj mogu upotrebljavati stručnjaci ili osposobljeni korisnici u trgovinama, lakoj industriji i na poljoprivrednim gospodarstvima ili laici u komercijalne svrhe.

<SRPSKI>

Prevod originala. Verzije na drugim jezicima su prevodi originala.

▲ OPREZ

- Curenje rashladne tečnosti može da dovede do gušenja. Obezbedite ventilaciju u skladu sa EN378-1.
- Obavezno obmotajte izolaciju oko cevi. Direktni kontakt sa golom cevi može izazvati opekotine ili promrzline.
- Nikada nemojte stavljati baterije u usta iz bilo kog razloga, kako bi se sprečilo slučajno gutanje.
- Gutanje baterija može da izazove gušenje i/ili trovanje.
- Ugradite jedinicu na čvrstu strukturu kako biste sprečili previše jak zvuk rada ili vibracije.
- A-ponderisani nivo jačine pritiska zvuka je ispod 70 dB.
- Ovaj uređaj je namenjen za upotrebu od strane stručnih ili obučanih korisnika u prodavnicama, u lakoj industriji i na farmama ili za komercijalnu upotrebu od strane nekvalifikovanih lica.

This product is designed and intended for use in the residential, commercial and light-industrial environment.

Importer:

Mitsubishi Electric Europe B.V.
Capronilaan 46, 1119 NS, Schiphol Rijk, The Netherlands

French Branch
25, Boulevard des Bouvets, 92741 Nanterre Cedex, France

German Branch
Mitsubishi-Electric-Platz 1, 40882 Ratingen, Germany

Belgian Branch
Autobaan 2, 8210 Loppem, Belgium

Irish Branch
Westgate Business Park, Ballymount, Dublin 24, Ireland

Italian Branch
Centro Direzionale Colleoni, Palazzo Sirio-Ingresso 1 Viale Colleoni 7, 20864 Agrate Brianza (MB), Italy

Norwegian Branch
Gneisveien 2D, 1914 Ytre Enebakk, Norway

Portuguese Branch
Avda. do Forte, 10, 2799-514, Carnaxide, Lisbon, Portugal

Spanish Branch
Carretera de Rubi 76-80 - Apdo. 420 08173 Sant Cugat del Valles (Barcelona), Spain

Scandinavian Branch
Hammarbacken 14, P.O. Box 750 SE-19127, Sollentuna, Sweden

UK Branch
Travellers Lane, Hatfield, Herts., AL10 8XB, England, U.K.

Polish Branch
Krakowska 50, PL-32-083 Balice, Poland

Please be sure to put the contact address/telephone number on this manual before handing it to the customer.

MITSUBISHI ELECTRIC CORPORATION

HEAD OFFICE: TOKYO BUILDING, 2-7-3, MARUNOUCHI, CHIYODA-KU, TOKYO 100-8310, JAPAN