



PRODUCT RANGE > HORIZONTAL SLIDING >

Slimline 10 (HS)

A versatile horizontal sliding system in 2, 3 and 4 pane options that provides easy access to the external window for ventilation. Slim profiles make it suitable for heritage properties.

Recommended maximum frame sizes

HORIZONTAL SLIDING

	Height (mm)	Width (mm)
2 Pane	2200	2800
3 Pane	2200	4200
4 Pane	2200	4900

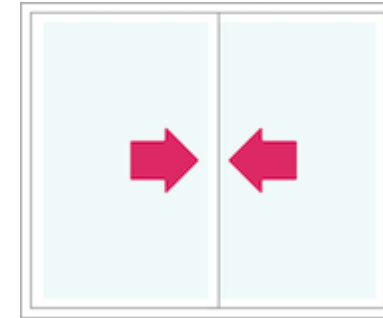

Slimline 10 (HS)

Mid-range 15 (HS)

Heavy Duty 80 (HS)

Security 85 (HS)

Glazing Range

4 mm to 6.8 mm

Frame Finishes

Standard white (HIPCA semi-gloss).

Any standard powder paint, wood grain finish or anodised finish to order.

[Secondary glazing products](#)

Gallery



Style and Details

Performance

Ironmongery

Specification

Styles available

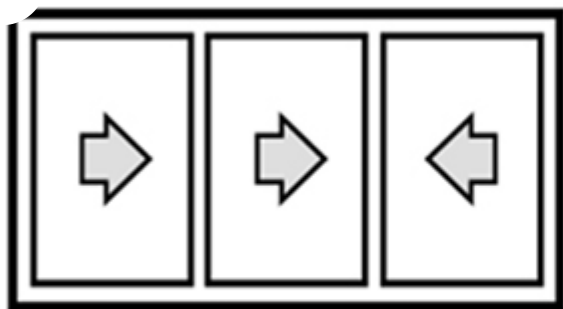

3 pane horizontal slider - centre

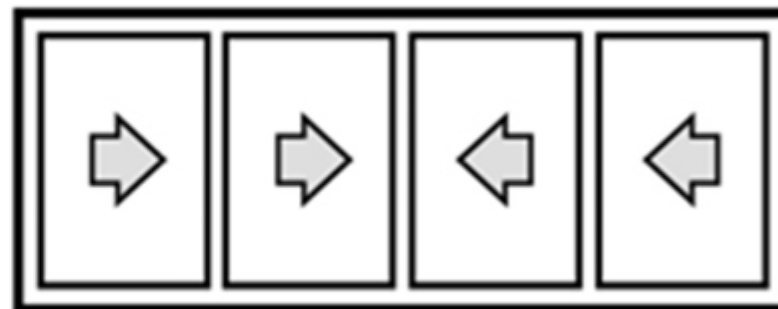

4 pane horizontal slider

Section diagrams

Plan section

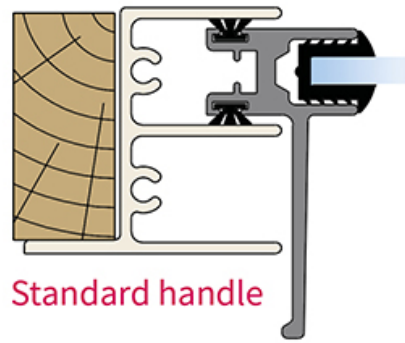

Standard handle

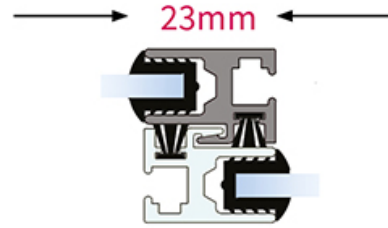

Standard interlock

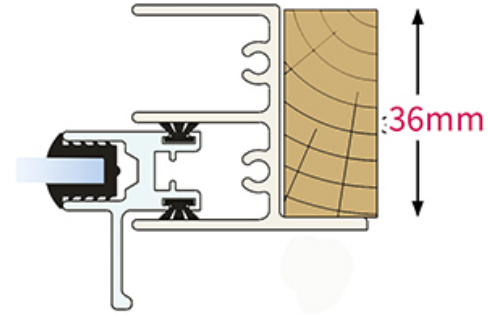

Plan section options

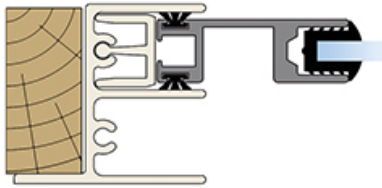

Recessed finger pull

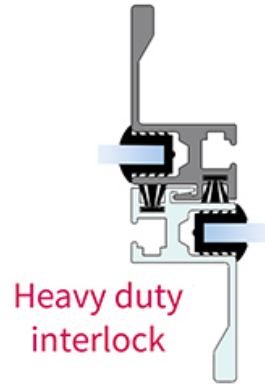

Heavy duty interlock

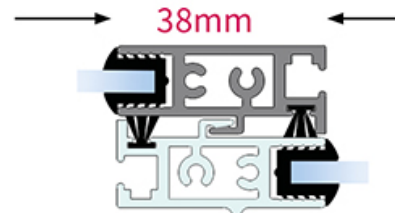

Box interlock

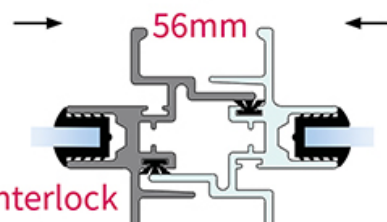

Butt interlock

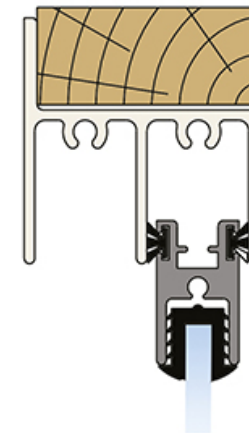

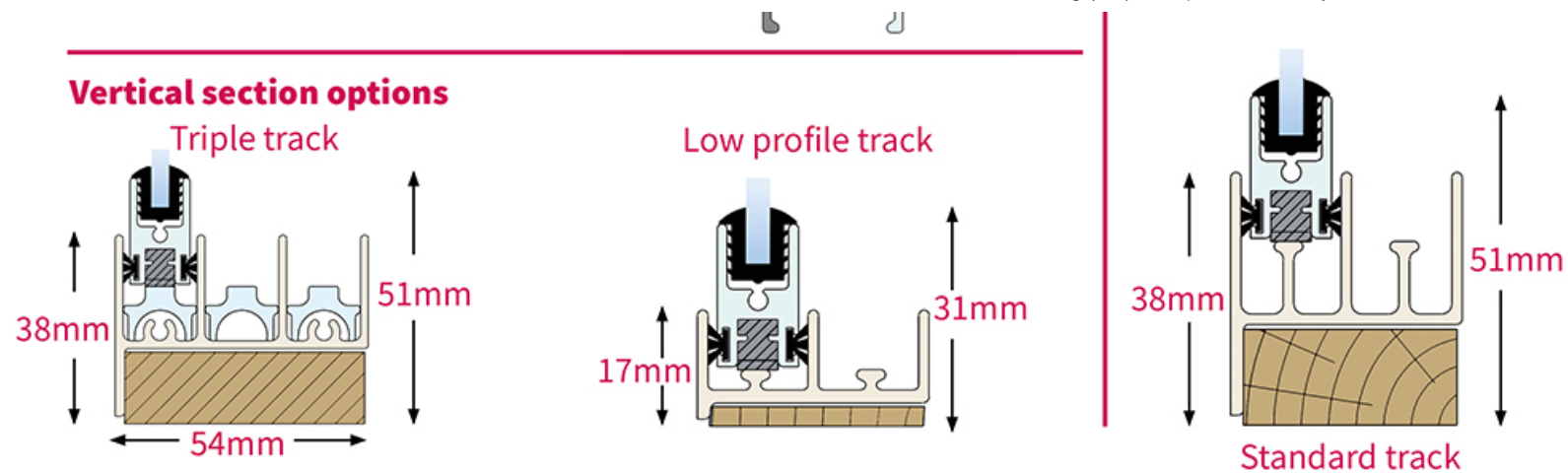

Never miss one bit!

Subscribe to our monthly Newsletter to receive updates on our news and CPD initiatives.

First Name*

Last Name*

E-mail address*

SUBSCRIBE



[PAY AN INVOICE](#)

[CONTACT FORM](#)

ABOUT US

[About Selectaglaze](#)

[Our Services](#)

[Our Values](#)

[Our Sustainability](#)

[Our Team](#)

[Accreditations and Affiliations](#)

[Our Policies](#)

[Careers at Selectaglaze](#)

OUR PRODUCTS

[Product Range](#)

[Arched and Shaped Windows](#)

BLOGS & EVENTS

ABOUT SECONDARY GLAZING

[What is Secondary Glazing?](#)

[Benefits](#)

[Heritage and Listed Buildings](#)

[Sustainability of Secondary Glazing](#)

[Case Studies](#)

[Brochures](#)

[FAQs](#)

[Sectors](#)

TECHNICAL SUPPORT

[Technical Downloads](#)

[RIBA Approved CPDs](#)

Blog and News Articles

Events

Selectaglaze Limited

Alban Park

Hatfield Road

St Albans

AL4 0JJ

enquiries@selectaglaze.co.uk

+44(0)1727 837271



TERMS AND CONDITIONS

PRIVACY POLICY

COOKIE POLICY

© 2023 SELECTAGLAZE LIMITED ALL RIGHTS RESERVED