

ACO Water Management: Civils + Infrastructure

Uniclass L7312	
Cl/SfB (52.9)	

ACO MonoDrain®

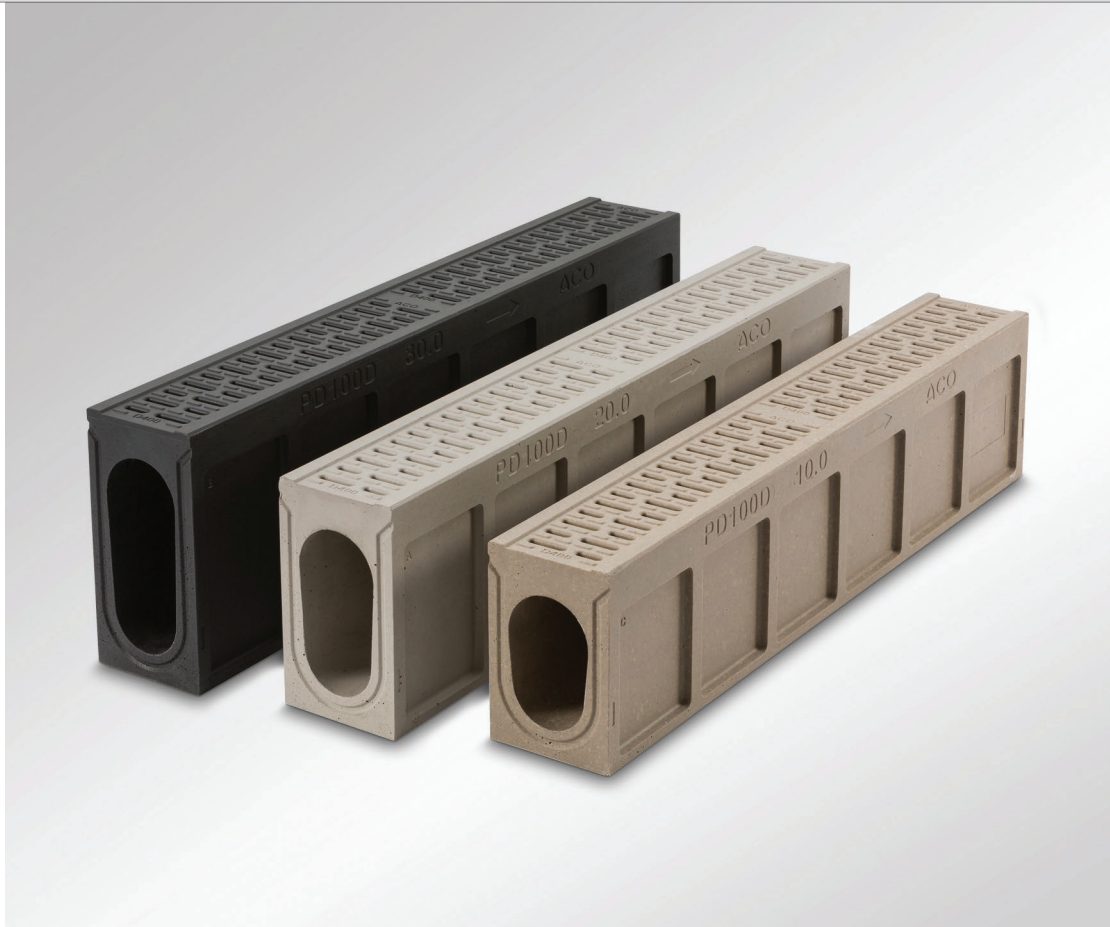

EXTENDED RANGE

ACO MonoDrain®

Heelguard™ monocast channel drainage system



Introduction to the ACO Group

Throughout the world ACO branded drainage and surface water management systems are recognised for their innovative design, high quality manufacture, environmental excellence and industry leading performance.

Today the ACO Group has a research and production base that reaches across four continents. This unmatched resource pioneers the development of solutions that are tailored to individual applications, meeting the need for high performance, sustainable products that deliver optimum value throughout their operational life.

ACO Technologies plc

ACO operates as ACO Technologies plc in the United Kingdom. Founded over 30 years ago, the company has grown quickly on a reputation for design innovation and customer service.

There are now two divisions within ACO Technologies that serve every sector of the construction industry, providing solutions for applications as diverse as rail, highways, airports, landscaping, retail, distribution centres and environmentally sensitive projects.



To help architects, designers and contractors meet the legal requirements that now tightly control the way surface water is managed, ACO has created its unique 'Surface Water Management Cycle' – Collect, Clean, Hold, Release – the four core processes now required for the complete and sustainable management of surface water drainage.



Contents

Introduction to ACO MonoDrain®	4
Features overview	6
Channel range layout	8
Safety and long term performance	10
Installation and maintenance benefits	11
Aesthetics	12
Material benefits	14
<hr/>	
ACO MonoDrain® PD100D system	
ACO PD100D channels	16
ACO PD100D shallow channels	17
ACO PD100D accessories	18
<hr/>	
ACO MonoDrain® PD150D system	
ACO PD150D channels	21
ACO PD150D accessories	22
<hr/>	
ACO Universal Gully	24
Preparing a system for installation	25
Installation detail	28
Designing an ACO MonoDrain® drainage system	30
Chemical resistance chart	31
Specification clauses and certification	32



Introduction to ACO MonoDrain®

The new ACO MonoDrain® is a one-piece channel drainage system that delivers multiple benefits including safety and sustainability, economical and efficient installation and aesthetic choices across applications such as stations, schools, car parks and commercial areas.

What is ACO MonoDrain®?

Designed to maintain the long term performance and appearance of the installation, its robust one piece construction removes the risks associated with dislodged or stolen gratings – providing a highly effective alternative to traditional two part channel and grating systems.

The 1m channel units for the core of the range and are available in two widths and a range of constant depths.

ACO MonoDrain® channels are constructed in one-piece with an integral Heelguard™ grating, making the product incredibly strong and robust, yet light enough for quick installation.

Specification couldn't be easier as all channels and accessories are certificated to BS EN 1433:2002 load class D 400*.

The monocast channels are available in Black, Grey and Natural Vienite® to complement a wide range of pavements.

Manufactured from Vienite®, ACO's high performance recycled material, the system delivers the highest levels of quality, installation and environmental benefits required for modern construction projects, yet has none of the performance compromises associated with other recycled materials on the market.

Maintenance is provided for by lockable rodding access points, sumps and gully units which allow the system to be simply and efficiently cleaned by standard jetting equipment.



Typical applications

All channels and accessories are certificated to BS EN 1433:2002 load class D 400* so are suitable for a wide range of applications plus the monocast construction means they are suited to applications, the monocast where pedestrian safety is a key consideration:

- ▶ Car parking
- ▶ Train Stations/platforms
- ▶ Schools
- ▶ Concrete or stone installations (grey range)
- ▶ Paving installations
- ▶ Hospitals
- ▶ Prisons
- ▶ Threshold drainage
- ▶ Public Landscaping
- ▶ Commercial areas
- ▶ Light industrial

*ACO MonoDrain® system is not suitable for carriageways of public roads or motorways - for these applications consider the use of ACO RoadDrain

Why choose ACO MonoDrain®?

Safety and long term performance

ACO MonoDrain® is a robust one-piece drainage channel that removes the risks associated with dislodged or stolen gratings with an integral anti-theft grating design.

Heelguard™ inlets and Load Class D 400* strength make the channels suitable for most pedestrian and parking applications and are compliant to BS EN1433:2002.

Installation & maintenance benefits

The one metre channel is quicker to install than standard 0.5m sizes, and with no gratings to install, even more time is saved.

The D 400* load class product does not require as much concrete haunching as equivalent channels and so saves on installation.

ACO MonoDrain® channel systems include sump units and access units which allow easy to use access points for maintenance.

Aesthetics

ACO MonoDrain® channels come in three colour options, black, grey and natural to give specifiers and landscapers the opportunity to co-ordinate or contrast with the surrounding surfaces.

The properties of the polymer concrete material limit the risk of discolouration whilst protecting the long term appearance of the system.



- ▶ Safe and secure installation
- ▶ Integral anti-theft grating design
- ▶ Proven performance and durability
- ▶ Manufactured from sustainable material
- ▶ Simplifies specification and design
- ▶ Capacity choices optimise hydraulic performance
- ▶ Requires less concrete haunching
- ▶ Many design configurations available including constant depth, step fall, T and L junctions
- ▶ High daily installation rate
- ▶ Maintenance friendly Integral Heelguard™ inlets for a 'heel-friendly' surface



NEW ACO Hydraulic Design Software

Register online for our free, secure online design software:

- ▶ All designs are securely stored and easily accessed online
- ▶ Data always up-to-date
- ▶ Proven calculation methodology - more accurate and efficient designs
- ▶ Flexible catchment design
- ▶ Integrated rainfall data
- ▶ Automated product optimisation
- ▶ PDF summary documents



Register Now - It's Free

www.aco.co.uk/quad-hydraulic-design-2.0

ACO MONODRAIN® CHANNEL FEATURES OVERVIEW

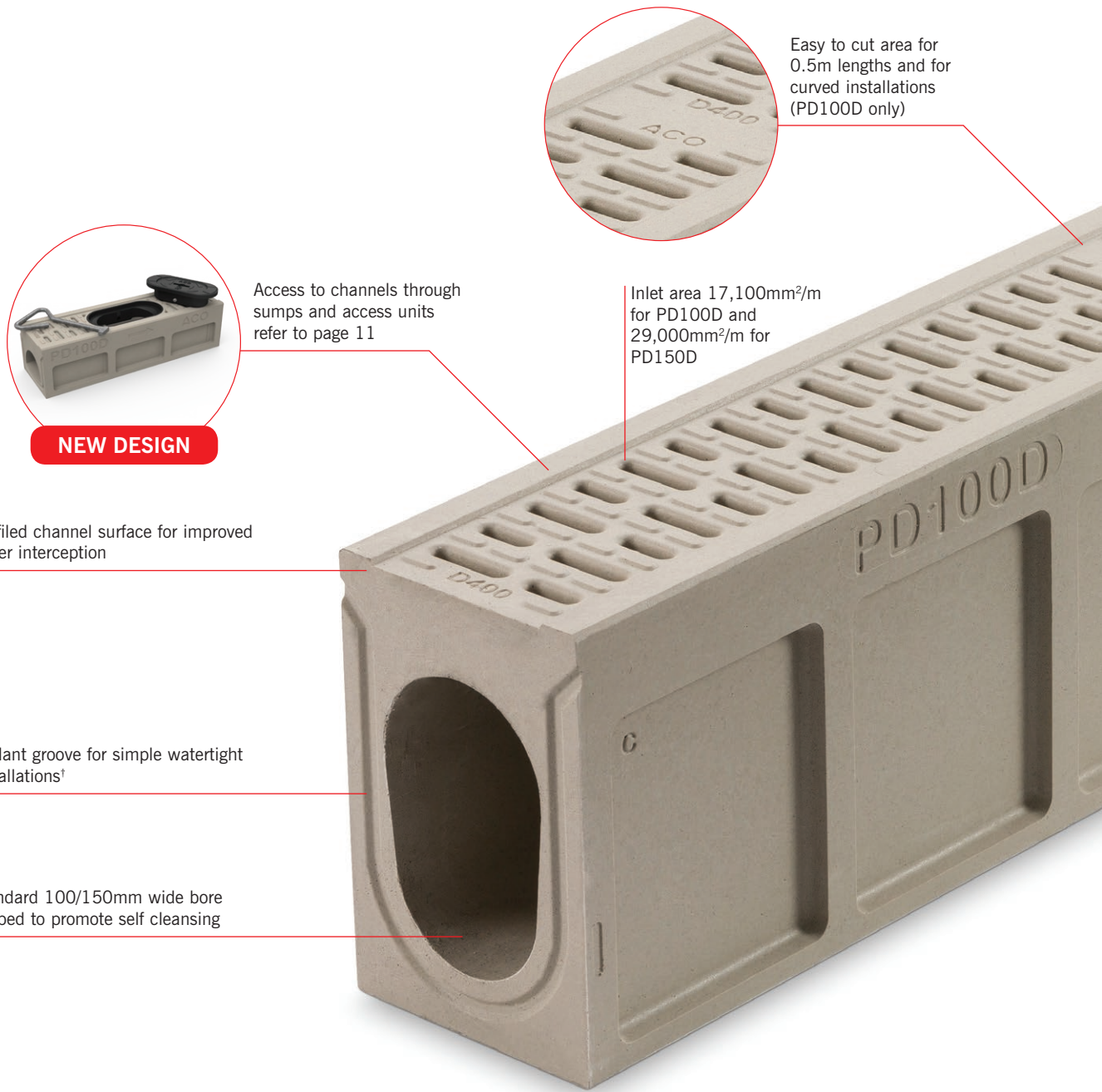

Available channel sizes - PD100D:

PD100D 30.0

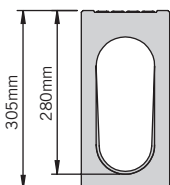

PD100D 20.0

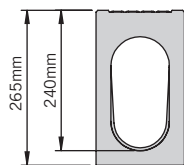

PD100D 10.0

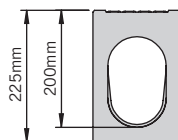

PD100D 0.0

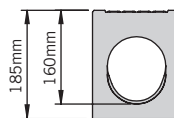

PD100D shallow

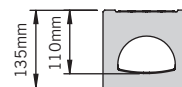

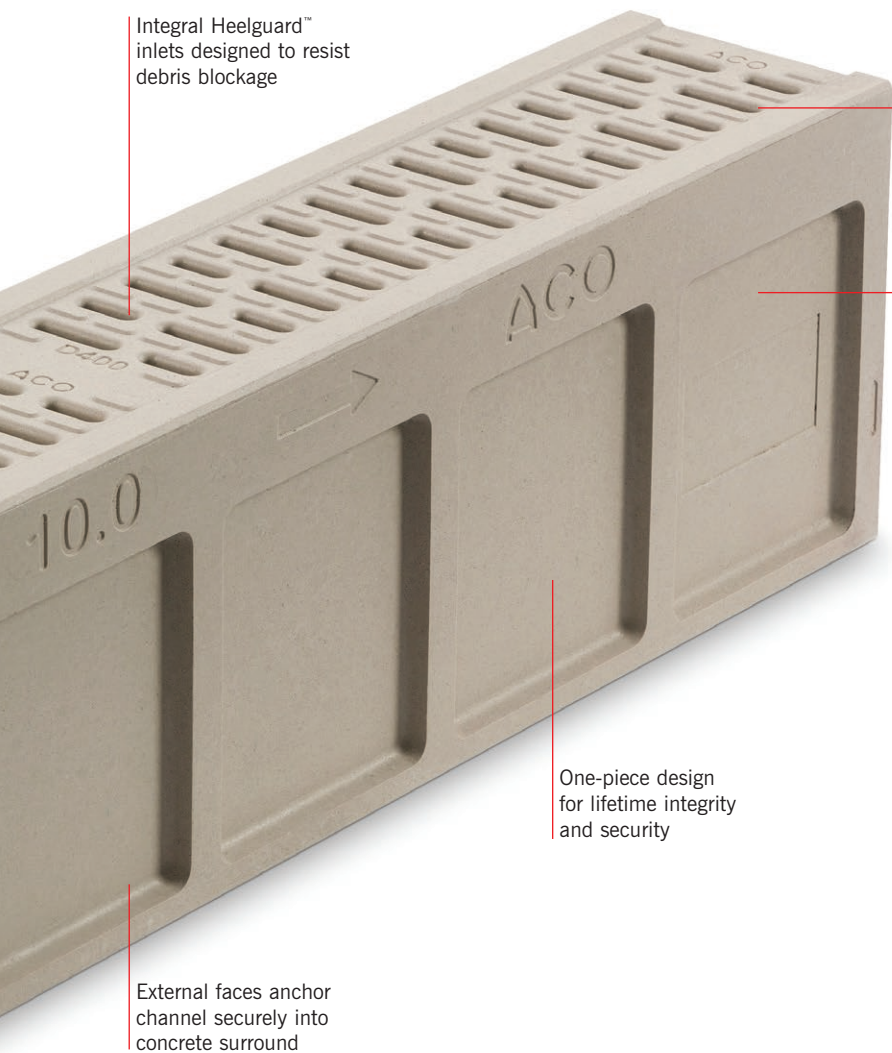

Integral Heelguard™ inlets designed to resist debris blockage

Recessed inlets for improved water interception and raised profiles for skid and slip resistance

Made from sustainable, robust materials which are thermally stable, chemically resistant and environmental friendly. Manufactured from Vienite®



One-piece design for lifetime integrity and security

External faces anchor channel securely into concrete surround

Colour options

Black

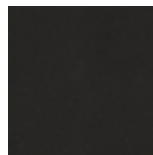

Grey

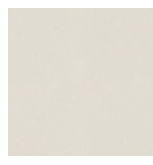

Natural



LOAD CLASSES



A 15 Pedestrian, cycleways, minimally trafficked areas (light domestic vehicles only).



B 125 Pedestrian precincts, car parks and drives.



C 250 Parking areas, service stations (cars) and slow-moving light commercial vehicles.



D 400 Parking areas for all types of vehicles*

Available channel sizes - PD150D:

PD150D 0.0

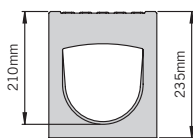

PD150D 10.0

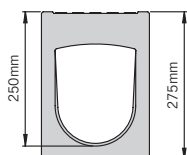

PD150D 20.0

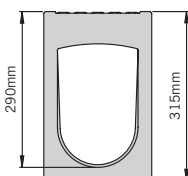

* The ACO MonoDrain® system is not suitable for carriageways of public roads or motorways.

† ACO MonoDrain® channels are tested to confirm compliance with the watertightness requirements of BS EN 1433 when filled with water to the top of the channel bore. See the watertightness note on page 26 for more information.

ACO MonoDrain® system layout

The layout diagram below illustrates the channels and components available with the ACO MonoDrain® range.

To support a wide variety of catchment depths, hydraulic capacities and applications, the system is available in a range of constant and shallow depth channels to suit the drainage design.

The layout below illustrates the channels and accessories available within the ACO MonoDrain® range and to aid product selection, a summary of the function and feature of each component is provided.

ACO MonoDrain® access units have thermoset composite plastic components set within the polymer channel for easy and quick access. Further details can be found on pages 22 and 23 of this brochure.

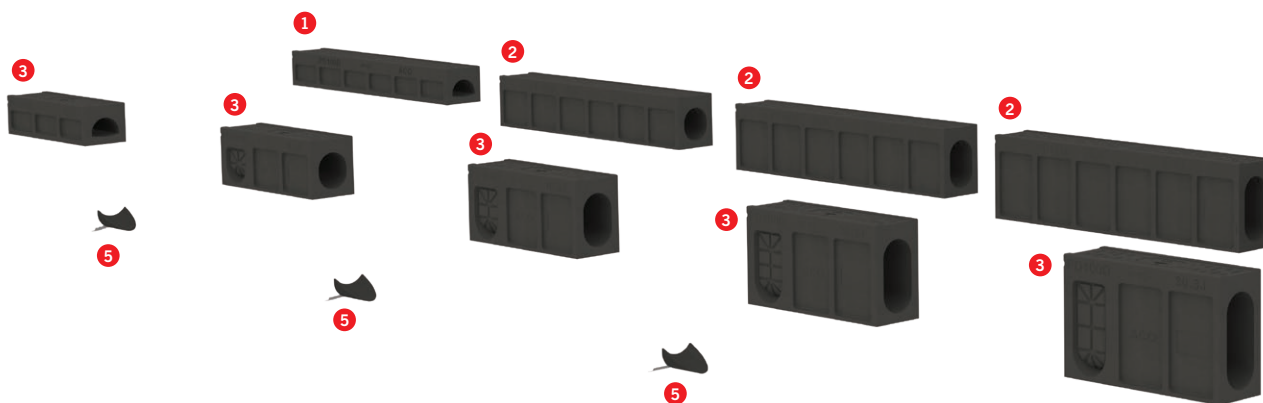

1 Shallow depth channels



- ▶ **100mm wide bore:** One shallow channel unit is available in 1m lengths with an overall depth of 135mm

Shallow access units supplied with preformed Ø110mm knockout for vertical connection.

2 Constant depth channels



- ▶ **100mm wide bore:** Four constant depth channel units are available in 1m lengths with overall depths ranging from 185mm to 305mm.
- ▶ **150mm wide bore:** Three constant depth channel units are available in 1m lengths with overall depths ranging from of 235mm to 315mm.

3 Access channels – 0.5m



- ▶ **100mm wide bore:** Five constant depth access units are available in 0.5m lengths with overall depths ranging from 135mm to 305mm.
- ▶ **150mm wide bore:** Three constant depth channel units are available in 0.5m lengths with overall depths ranging from of 235mm to 315mm.

These channels include vertical knockout for connection to Ø110mm pipework and side knockout for 90° channel connections.



5 Step Connector

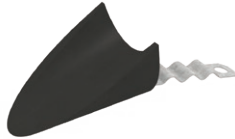

A polymer concrete unit which helps provide smooth water transition between constant depth channels when used in a stepped system design. The step connector is suitable for the step between each of the constant channel depths, and two sizes are available for P100D and P150D ranges.

6 Universal Sump



Each system width has one 0.5m universal sump for connection to all channels. Various outlet options for pipe and foul air trap connection. Plastic silt bucket provided with each unit.

7 Universal gully



One universal gully for all applications. Standard features include ductile cast iron cover, silt bucket and roddable foul air trap for connection to Ø160mm PVC-U pipe.



4 Multifunctional endcap



One plastic multifunctional endcap for each channel width. Provides a closing or outlet option to Ø110mm (100mm wide bore channels) or Ø160mm (150mm wide bore channels) pipes.



Guidance for using the ACO MonoDrain® parts tables

The ACO MonoDrain® parts tables are shown on the following pages. The product information is split down by channels widths and further by channel depth. This is to enable quick and simple product identification and selection. The tables for ACO MonoDrain® (1 or 3) channels list a number associated with the Invert Type. This number highlights the drainage design which can be achieved when using these channels. The key for the Invert Type is shown opposite.

Channel invert types



1 Constant Depth Invert



3 Stepped Invert

Safety and long term performance

Heelguard™ inlets are standard with ACO MonoDrain's® range of channels, with 'Heel-friendly' slot widths of 8mm (PD100D) or 10mm (PD150D). They are suitable for most pedestrian applications and compliant to BS EN1433:2002. ACO MonoDrain® channels have raised side edges which effectively trap water entering the grate, and raised profiles offer effective skid and slip resistance

No dislodged or stolen grates

ACO MonoDrain® is a monolithic channel, which means that it is manufactured as one-piece. The benefit of this is that there is no grate to become potentially dislodged or stolen.

In areas such as schools or prisons a non-grated system may be especially desirable. The system also features high strength access units with thermoset plastic access covers.

The use of this material means that the lids have no scrap value which will deter theft. This innovative access unit also features a self-locking mechanism ensuring that units can not be accidentally left unlocked.



ACO MultiDrain® Heelguard™ slotted grate

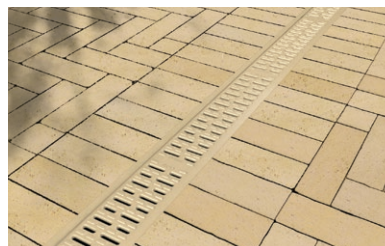

ACO MonoDrain® Heelguard™ inlets

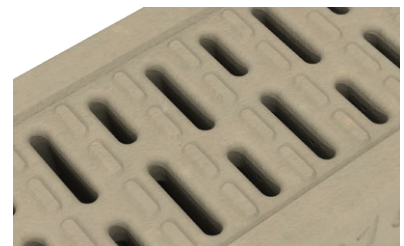

ACO MonoDrain® Heelguard™ inlet detail

Hydraulic performance

Once installed MultiDrain and MonoDrain perform hydraulically in the same way.

Intake areas and hydraulic capacity are very similar, making it easy to compare the two systems for the same site

Polymer resistance to corrosion

Performance

ACO MonoDrain® channels are made from Vienite®, ACO's high strength polymer concrete. ACO MonoDrain® 1000mm channels do not contain any metal components, meaning that they are not at risk of corrosion like standard grated systems. This can be of particular concern in coastal areas or sites wishing to reduce their long-term maintenance costs.

The ACO MonoDrain® range has reduced the metal components within the whole system by incorporating an innovative thermoset plastic access cover within the access units. This access cover has a quick self-locking system, manufactured from stainless steel components, and provides a long-term solution to corroded access lids.



P100D Access unit



Installation and maintenance benefits

Material costs

ACO are constantly striving to improve our product range to offer added benefits for customers/installers. ACO MonoDrain® has replaced Monoblock as ACO's D 400 monolithic channel and with this change comes added benefits in terms of installation costs. ACO MonoDrain® is an extremely strong and robust channel and achieves Load Class D 400 under BS EN 1433:2002 with a reduced haunch size of 100mm.

Compared to Monoblock which required 308kg of concrete per metre, MonoDrain only requires 172kg - a 41% reduction in concrete.

The reduced amount of concrete equates to approximately £5.07 per metre*

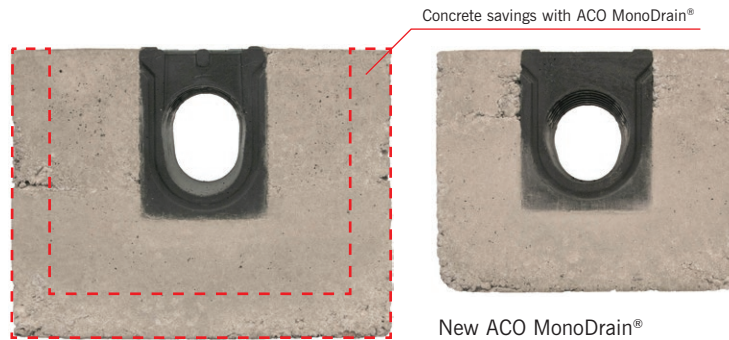

Time costs

ACO MonoDrain® is a one metre channel compared to Monoblocks 0.5m channel which has benefits during installation.

Not only is it quicker to level a run of 1m channels compared to half meter sections, the added length also decreases the amount of time needed to seal the channels if required on site.

The one piece monolithic design also means that time is saved by not having to install grates along the entire channel run.

Quick and easy maintenance

One of the most common questions regarding monolithic channels is "How do I clean it?" The answer is: exactly the same way as a grated channel.

Whether grated or non-grated it is recommended that cleaning of the channels is completed using a pressure jetting head which enters through an access or sump unit and travels the length of the system cleaning as it goes. Even if the system was grated it is not recommended that you lift every grate to clean the channel run, as this would take a disproportionate amount of time and increase the risk of damage to old grates.

ACO MonoDrain® channel systems should be installed with regular access or sump units which provide easy to use access points for maintenance.

Manufactured from Vienite®, the internal bore's cross-sectional design and extremely smooth surface, mean it has a Mannings coefficient of friction of 0.011 giving enhanced hydraulic performance and resisting the build up of silt and debris.

Over the life of a standard grated system, the grates may require corrosion resistant paint to be applied to improve the life and aesthetics of the product. With a monolithic product like MonoDrain this maintenance issue is not required.

Radius @ 45° = 290mm

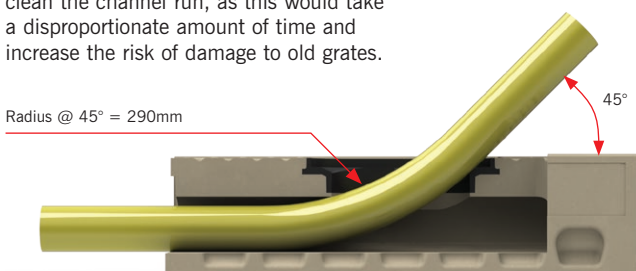

* 150mm haunch Monoblock, vs 100mm MonoDrain for 0.0 channels, price of concrete £90 per m³ (priced August 2017).

Surface design detail

Bringing aesthetic choices to monocast channels

Style, aesthetics, performance and reliability are all important factors when specifying surface water management systems. Globally recognised as the no. 1 choice in managing surface water, ACO provide designers with the widest range of channel and grating styles to choose from.

By using a range of different design options including light, form, texture, material and colour, ACO's grating and channel styles can be used to complement or enhance many landscape designs.

MonoDrain® aesthetic applications

Now ACO have expanded the aesthetic choices into their monocast channels with a range of three colour options and the all-in-one aesthetic and channel solution takes away the complexities and costs

of adding in galvanised and steel grating options.

The aesthetic application choice depends on the design but the black is suggested

for blending with asphalt, grey a compliment to concrete and stone and the natural look has a sandy affect that works well with earthen pavers.



Black - Asphalt installations



Grey - Concrete installations



Natural - Paving installations



Urban Surface Design

Designing surface water run-off in urban environments

Designing Lines

The term 'line' typically relates to structures within a landscape - the edges of footpaths or flower beds and how they link with open space; in domestic environments it references things like the perimeter of a patio or deck. ACO MonoDrain® channel lines can be utilised to critically influence the flow of any landscape, not least in the urban environment.



Texture + Material

While texture in landscapes is often created using plants and vegetation it can also be created using hard materials. Fineness or coarseness, roughness or smoothness, heaviness or lightness are all considerations frequently considered in the detail of urban surface design. ACO MonoDrain's smooth and hard polymer concrete has raised profiles for skid and slip resistance to add texture to an environment.



Scale

In urban design, scale refers to the size relationship between elements within structures and the surrounding 'space'. Frequently it is also the surface elements within the 'space' that contribute to a visual perspective. Consequently it is important to make size choices that are suitable for the setting and the scale of the design. ACO MonoDrain's scale is in its depth so it can integrate into shallow environments.



For more information on Urban Surface Design visit www.aco.co.uk

Surface + Grating
Visualiser



To make specification easier, the software will suggest our most suitable ranges based on the project requirements.

You can then select from the available options and visualise how these may look in different surface finishes. Once a choice is made, a simple, yet detailed specification sheet provides full product information.



To launch the visualiser scan the QR code or visit www.aco.co.uk/gratingvisualiser

ACO MonoDrain® colour choices

A new range of contemporary colours will add character and style to any landscape project.

Black ACO MonoDrain®



Channels blend seamlessly with asphalt surfaces, and deeper shades of pavers.

Grey ACO MonoDrain®



An alternative to galvanised or stainless steel grates, providing a similar grey aesthetic for concrete or stone installations.

Natural ACO MonoDrain®



A subtle sandy colour that is a perfect accompaniment to stone or earthen pavers as well as near grass areas.

Wienerberger pavers featured

ACO MonoDrain® shallow channels

ACO MonoDrain® is a versatile range, not only available in three colour options but also in five depths which are suitable for a wide range of hydraulic and site requirements. Featured above is ACO MonoDrain® shallow channel, which is particularly suited to areas where excavation depth is limited such as train platforms.

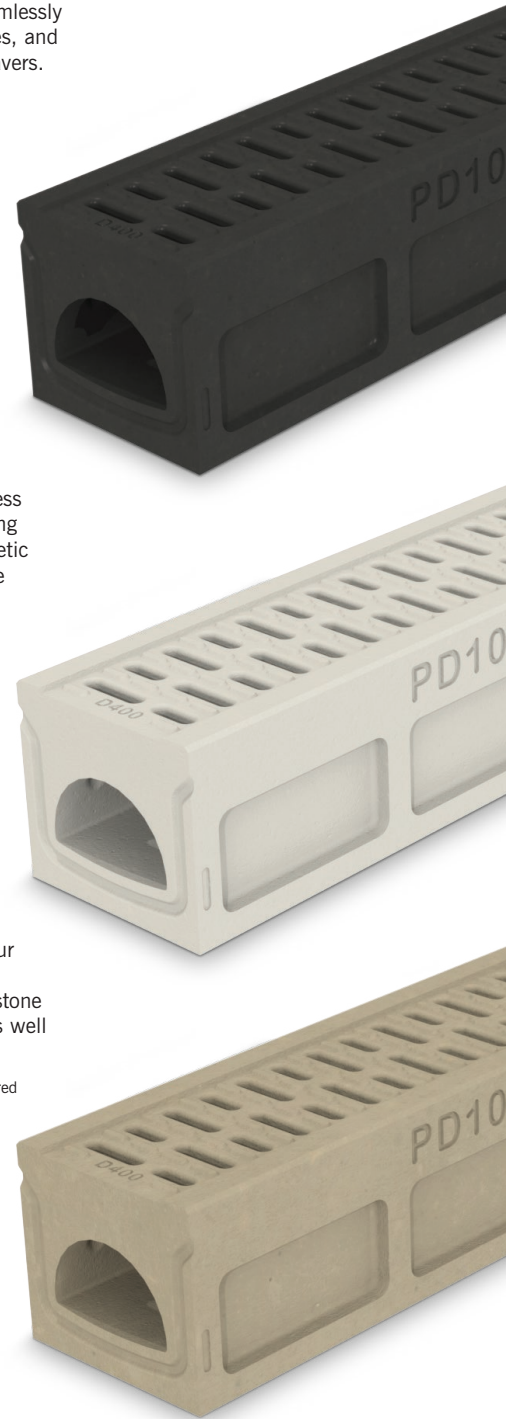

Material benefits and performance

The correct material selection for products installed in permanent works is extremely important to assure optimum performance throughout its design life.

ACO MonoDrain® channels are manufactured from Vienite®, ACO's sustainable high strength material.

This material offers distinct advantages over other products and materials, addressing key specification and performance requirements for engineers and designers.

High overall strength

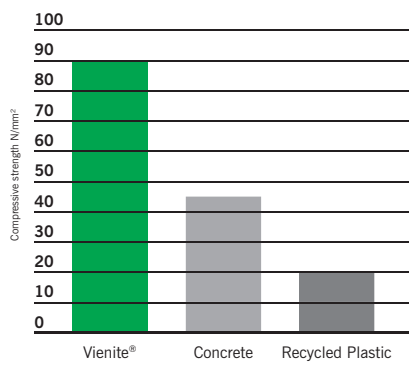

Vienite® has high compressive strength and is therefore extremely resistant to service loads.

Strong flexural strength

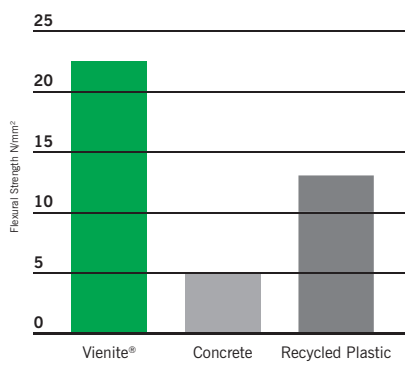

Vienite® has excellent flexural strength making the product resistant to side loads typically encountered during surfacing and installation.

Low expansion

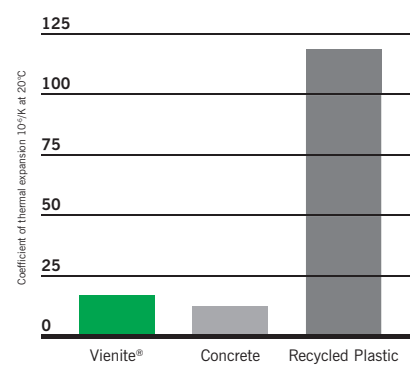

Vienite® has a low coefficient of thermal expansion making it extremely stable, and unlike some materials it will not buckle or distort if subjected to high or low temperatures during service.



Superior electrical safety

The ACO MonoDrain® monolithic design eliminates the need for metallic components such as grates and rails, greatly reducing the electrical risks associated with traditional drainage systems. The ACO Vienite® polymer concrete construction is non-conductive making ACO MonoDrain® an ideal choice for applications such as rail platforms or other areas near electrical equipment and cabling.

Environmental impact and sustainable use of materials

Efficient use of material resources is a key contributor to sustainability in construction. ACO MonoDrain® has been carefully designed to maximise strength while minimising material use.

- ▶ Vienite® combines the mechanical and performance benefits of synthetic resin concrete with high levels of recycled fillers.
- ▶ Vienite® is a sustainable material that contains in excess of 20% by weight post consumer waste previously destined for landfill in the UK.
- ▶ Vienite® is recyclable, i.e. it can be collected, processed and returned for re-use as a raw material.

The ACO MonoDrain® sumps also includes components manufactured from ductile iron which contain between 40% and 90% recycled material.

Proudly designed and manufactured in Shefford, England. Not only does this give us full quality control, it reduces the carbon impact from transporting finished products.



ACO MonoDrain® PD100D

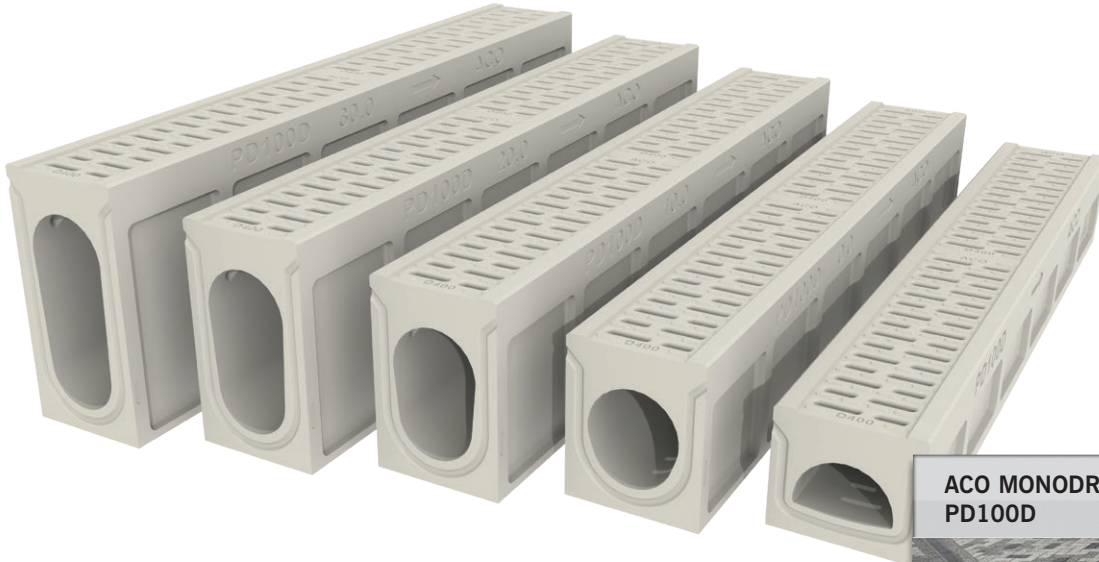

ACO MONODRAIN PD100D



100mm	Bore width
17,100mm ² /m	Intake area
✓	Heelguard
✓	Monolithic
✓	Access units
	Load Class

ACO MonoDrain® is a range of channels for installations which require a robust yet pedestrian friendly drainage system.

Designed as standard with heelguard 8mm drainage inlets, the inlets are integral to the channel which is a one-piece monolithic channel.

Compatible with most paving materials, and available in black, grey and natural polymer. Once installed the system is not vulnerable to vandalism or loose grates making it a suitable for applications such as schools and playgrounds where grating removal can become a hazard.

The system is suitable for applications up to and including Load Class D400 (this product is not suitable for carriageways of public roads or motorways).

ACO MonoDrain® channels are available with the following components:

- ▶ Multifunctional endcap
- ▶ Step connector
- ▶ Access units
- ▶ Universal sump
- ▶ Universal gully



ACO MonoDrain® PD100D

Constant depth channels and access units - Black

Product code	Description	Length (mm)	Width overall (mm)	Depth overall (mm)	Invert depth (mm)	Slot width (mm)	Invert Type	Weight (kg)
20600	PD100D No. 0.0 channel	1000	150	185	160	8	1/3	31.5
20603	PD100D No. 0.3J* access	500	150	185	160	-	1/3	16.8
20610	PD100D No. 10.0 channel	1000	150	225	200	8	1/3	34.6
20613	PD100D No. 10.3J* access	500	150	225	200	-	1/3	18.5
20620	PD100D No. 20.0 channel	1000	150	265	240	8	1/3	37.7
20623	PD100D No. 20.3J* access	500	150	265	240	-	1/3	20.1
20630	PD100D No. 30.0 channel	1000	150	305	280	8	1/3	40.8
20633	PD100D No. 30.3J* access	500	150	305	280	-	1/3	21.7

Constant depth channels and access units - Grey

Product code	Description	Length (mm)	Width overall (mm)	Depth overall (mm)	Invert depth (mm)	Slot width (mm)	Invert Type	Weight (kg)
26600	PD100D No. 0.0 channel	1000	150	185	160	8	1/3	31.5
26603	PD100D No. 0.3J* access	500	150	185	160	-	1/3	16.8
26610	PD100D No. 10.0 channel	1000	150	225	200	8	1/3	34.6
26613	PD100D No. 10.3J* access	500	150	225	200	-	1/3	18.5
26620	PD100D No. 20.0 channel	1000	150	265	240	8	1/3	37.7
26623	PD100D No. 20.3J* access	500	150	265	240	-	1/3	20.1
26630	PD100D No. 30.0 channel	1000	150	305	280	8	1/3	40.8
26633	PD100D No. 30.3J* access	500	150	305	280	-	1/3	21.7

Constant depth channels and access units - Natural

Product code	Description	Length (mm)	Width overall (mm)	Depth overall (mm)	Invert depth (mm)	Slot width (mm)	Invert Type	Weight (kg)
28600	PD100D No. 0.0 channel	1000	150	185	160	8	1/3	31.5
28603	PD100D No. 0.3J* access	500	150	185	160	-	1/3	16.8
28610	PD100D No. 10.0 channel	1000	150	225	200	8	1/3	34.6
28613	PD100D No. 10.3J* access	500	150	225	200	-	1/3	18.5
28620	PD100D No. 20.0 channel	1000	150	265	240	8	1/3	37.7
28623	PD100D No. 20.3J* access	500	150 <td 265	240	-	1/3	20.1	
28630	PD100D No. 30.0 channel	1000	150	305	280	8	1/3	40.8
28633	PD100D No. 30.3J* access	500	150	305	280	-	1/3	21.7

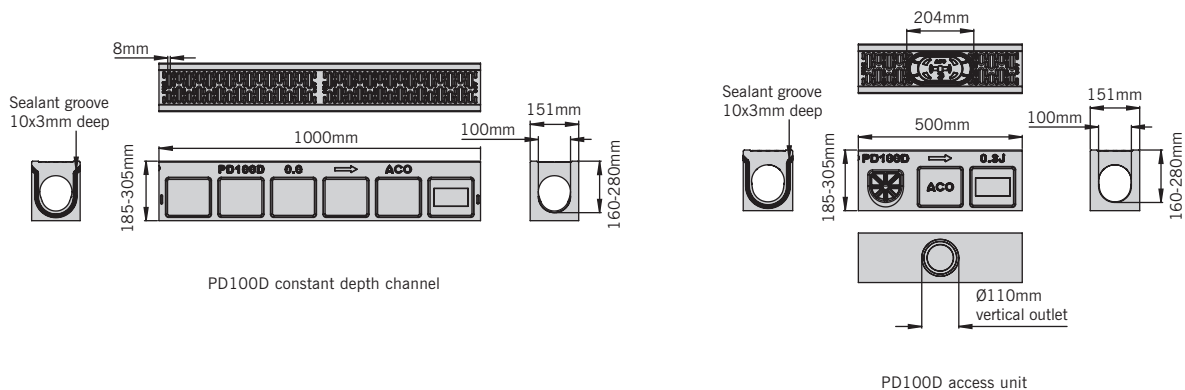

These products are subject to weight and dimensional tolerances. The dimensions shown on this page are for guidance purposes only.



Shallow depth channels and access units - Black

Product code	Description	Length (mm)	Width overall (mm)	Depth overall (mm)	Invert depth (mm)	Slot width (mm)	Invert Type	Weight (kg)
20640	PD100D Shallow channel	1000	150	135	110	8	1	26.0
20643	PD100D Shallow* access	500	135	110	-	1	13.6	

Shallow depth channels and access units - Grey

Product code	Description	Length (mm)	Width overall (mm)	Depth overall (mm)	Invert depth (mm)	Slot width (mm)	Invert Type	Weight (kg)
26640	PD100D Shallow channel	1000	150	135	110	8	1	26.0
26643	PD100D Shallow* access	500	150	135	110	-	1	13.6

Shallow depth channels and access units - Natural

Product code	Description	Length (mm)	Width overall (mm)	Depth overall (mm)	Invert depth (mm)	Slot width (mm)	Invert Type	Weight (kg)
28640	PD100D Shallow channel	1000	150	135	110	8	1	26.0
28643	PD100D Shallow* access	500	150	135	110	-	1	13.6

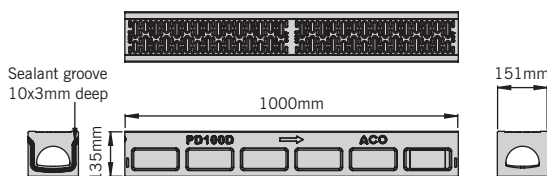

PD100D shallow depth channel

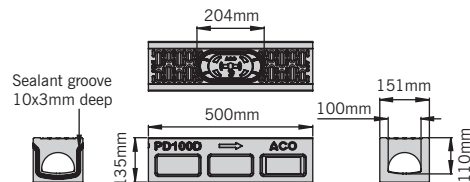

PD100D shallow access unit

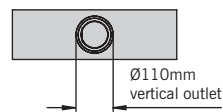

* Indicates channels supplied with preformed Ø110mm knockout for vertical connection. Note. For information on channel and access unit functionality see page 25. Access units supplied with thermoset composite plastic lockable covers. These products are subject to weight and dimensional tolerances. The dimensions shown on this page are for guidance purposes only. J Indicates side knockout for 90° channel connection. Knockout on both sides of the channel.



ACO MonoDrain® PD100D

Sump unit

Product code	Description	Length (mm)	Width overall (mm)	Depth overall (mm)	Invert depth (mm)	Slot width (mm)	Invert Type	Weight (kg)
20650	PD100D Universal sump unit with plastic silt bucket	500	150	725	706	8	-	50.3

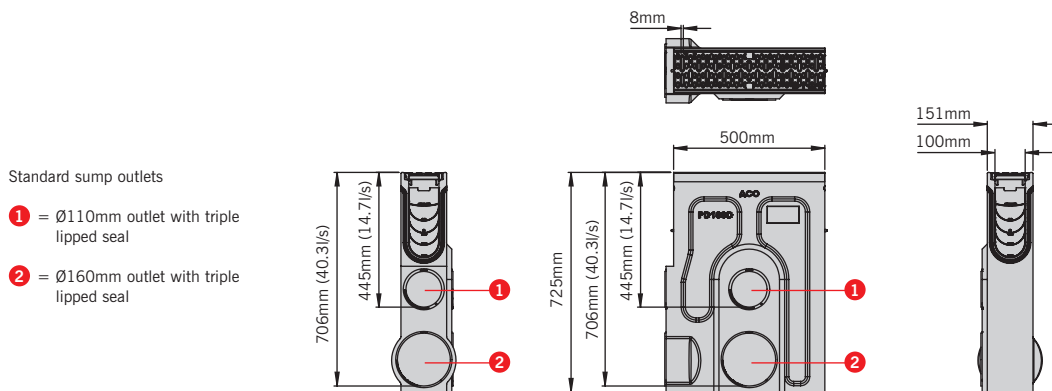

Note. Drawing shows flow through un-trapped unions. For information on sump unit functionality see page 27. Sump supplied with ductile iron lockable grating.

Grating accessories

Product code	Description	Length (mm)	Width overall (mm)	Depth overall (mm)	Invert depth (mm)	Invert Type	Weight (kg)
23415	Drainlock security locking assembly	n/a	n/a	n/a	n/a	n/a	0.1
23416	Drainlock security key	n/a	n/a	n/a	n/a	n/a	0.01
1367	Drainlock grating lifting tool 835	n/a	n/a	n/a	n/a	n/a	0.1



23415
Drainlock security locking assembly



23416
Drainlock security key



1367
Drainlock grating lifting tool 835

Drain unions and foul air traps

Product code	Description	Length (mm)	Width overall (mm)	Depth overall (mm)	Invert depth (mm)	Invert Type	Weight (kg)
0056	820 Drain union PVC-U Ø110mm	100	110	-	-	-	0.1
0058	822 Drain union PVC-U Ø160mm	100	160	-	-	-	0.5
2638	922 Foul air trap PVC-U Ø160mm	-	160	-	-	-	1.9
7932	950 Roddable foul air trap MDPE Ø160mm	-	160	-	-	-	0.8

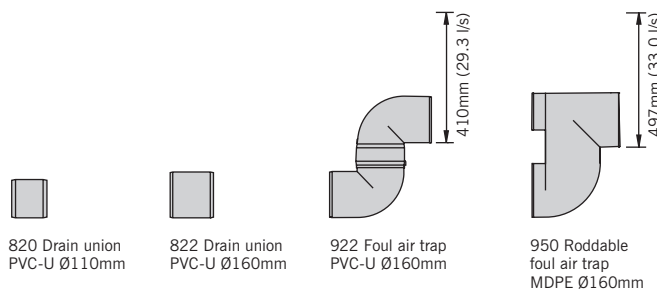

These products are subject to weight and dimensional tolerances. The dimensions shown on this page are for guidance purposes only.



Multifunctional end cap

Product code	Description	Length (mm)	Width overall (mm)	Depth overall (mm)	Invert depth (mm)	Slot width (mm)	Invert Type	Weight (kg)
20601	PD100D Multifunctional end cap	3	150	295	-	-	-	0.06

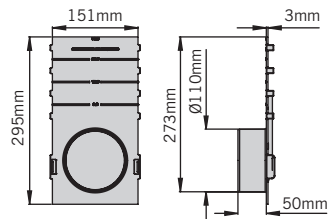

The multifunctional endcap can be cut down to suit all PD100D channels. See page 26 for further information.

Step Connector

Product code	Description	Length (mm)	Width overall (mm)	Depth overall (mm)	Invert depth (mm)	Slot width (mm)	Invert Type	Weight (kg)
20651	PD100D 40mm step connector	100	90	40	-	-	-	0.3

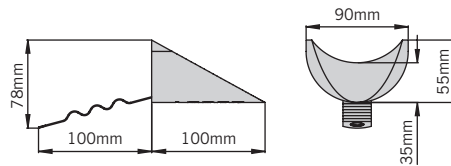

Note: For information on the step connector functionality see page 26.

ACO MonoDrain® PD150D



ACO MONODRAIN PD150D

150mm	Bore width
29,000mm ² /m	Intake area
	Heelguard
	Monolithic
	Access units
	Load Class

ACO MonoDrain® is a range of channels for installations which require a robust yet pedestrian friendly drainage system.

Designed as standard with heelguard 10mm drainage inlets, the inlets are integral to the channel which is a one-piece monolithic channel.

Compatible with most paving materials, and available in black, grey and natural polymer. Once installed the system is not vulnerable to vandalism or loose grates making it a suitable for applications such as schools and playgrounds where grating removal can become a hazard.

The system is suitable for applications up to and including Load Class D400 (this product is not suitable for carriageways of public roads or motorways).

ACO MonoDrain® channels are available with the following components:

- ▶ Multifunctional endcap
- ▶ Step connector
- ▶ Access units
- ▶ Universal sump
- ▶ Universal gully



ACO MonoDrain® PD150D

Constant depth channels and access units - Black

Product code	Description	Length (mm)	Width overall (mm)	Depth overall (mm)	Invert depth (mm)	Slot width (mm)	Invert Type	Weight (kg)
20800	PD150D No. 0.0 Channel	1000	200	235	210	10	1/3	48.6
20803	PD150D No. 0.3J* Access	500	200	235	210	-	1/3	25.6
20810	PD150D No. 10.0 Channel	1000	200	275	250	10	1/3	50.8
20813	PD150D No. 10.3J* Access	500	200	275	250	-	1/3	27.1
20820	PD150D No. 20.0 Channel	1000	200	315	290	10	1/3	54.8
20823	PD150D No. 20.3J* Access	500	200	315	290	-	1/3	28.7

Constant depth channels and access units - Grey

Product code	Description	Length (mm)	Width overall (mm)	Depth overall (mm)	Invert depth (mm)	Slot width (mm)	Invert Type	Weight (kg)
26800	PD150D No. 0.0 Channel	1000	200	235	210	10	1/3	48.6
26803	PD150D No. 0.3J* Access	500	200	235	210	-	1/3	25.6
26810	PD150D No. 10.0 Channel	1000	200	275	250	10	1/3	50.8
26813	PD150D No. 10.3J* Access	500	200	275	250	-	1/3	27.1
26820	PD150D No. 20.0 Channel	1000	200	315	290	10	1/3	54.8
26823	PD150D No. 20.3J* Access	500	200	315	290	-	1/3	28.7

Constant depth channels and access units - Natural

Product code	Description	Length (mm)	Width overall (mm)	Depth overall (mm)	Invert depth (mm)	Slot width (mm)	Invert Type	Weight (kg)
28800	PD150D No. 0.0 Channel	1000	200	235	210	10	1/3	48.6
28803	PD150D No. 0.3J* Access	500	200	235	210	-	1/3	25.6
28810	PD150D No. 10.0 Channel	1000	200	275	250	10	1/3	50.8
28813	PD150D No. 10.3J* Access	500	200	275	250	-	1/3	27.1
28820	PD150D No. 20.0 Channel	1000	200	315	290	10	1/3	54.8
28823	PD150D No. 20.3J* Access	500	200	315	290	-	1/3	28.7

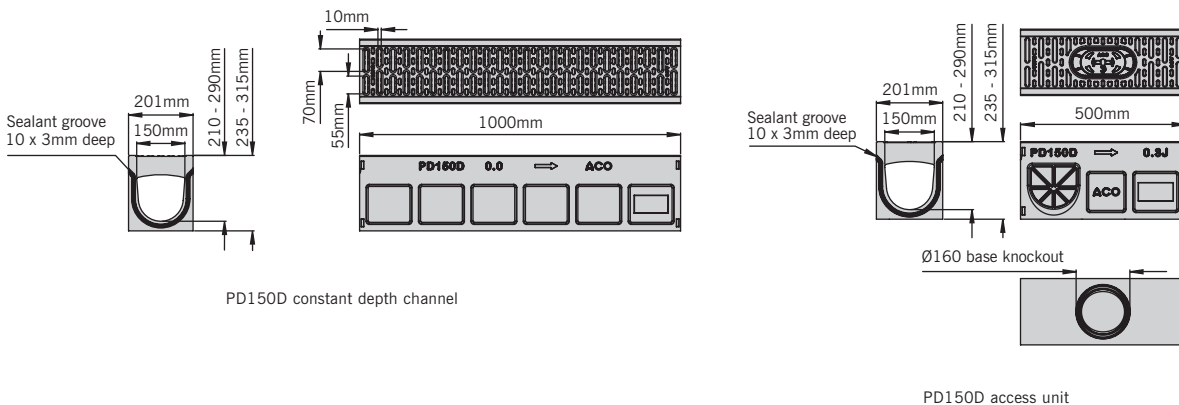

* Indicates channels supplied with preformed Ø160mm knockout for vertical connection. Note. For information on channel and access unit functionality see pages 25-26. Access units supplied with thermoset composite plastic lockable covers. These products are subject to weight and dimensional tolerances. The dimensions shown on this page are for guidance purposes only. J Indicates side knockout for 90° channel connection. Knockout on both sides of the channel. These products are subject to weight and dimensional tolerances. The dimensions shown on this page are for guidance purposes only.

ACO MonoDrain® PD150D

Sump unit

Product code	Description	Length (mm)	Width overall (mm)	Depth overall (mm)	Invert depth (mm)	Slot width (mm)	Invert Type	Weight (kg)
20850	MonoDrain PD150D sump	500	200	761	741	12	-	60.2

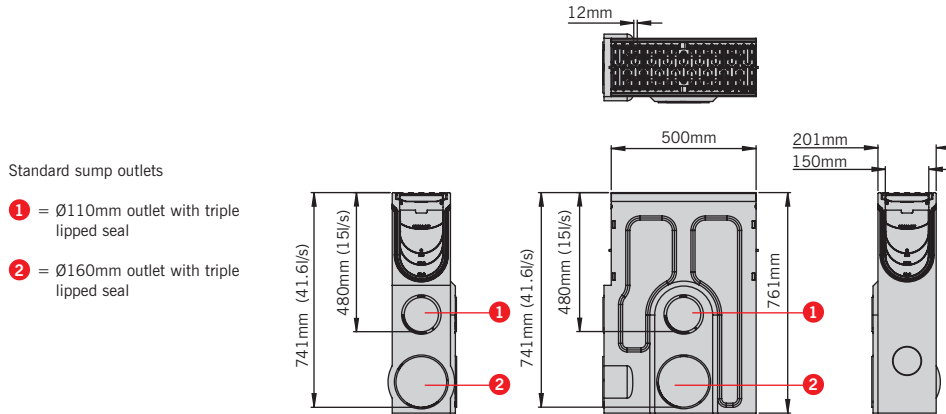

Note. Drawing shows flow through un-trapped unions. For information on sump unit functionality see page 27. Sump supplied with ductile iron lockable grating.

Grating accessories

Product code	Description	Length (mm)	Width overall (mm)	Depth overall (mm)	Invert depth (mm)	Invert Type	Weight (kg)
23165	Drainlock security locking assembly	n/a	n/a	n/a	n/a	n/a	0.1
23416	Drainlock security key	n/a	n/a	n/a	n/a	n/a	0.01
1367	Drainlock grating lifting tool 835	n/a	n/a	n/a	n/a	n/a	0.1



23165
Drainlock security locking assembly



23416
Drainlock security key



1367
Drainlock grating lifting tool 835

Drain unions and foul air traps

Product code	Description	Length (mm)	Width overall (mm)	Depth overall (mm)	Invert depth (mm)	Invert Type	Weight (kg)
0056	820 Drain union PVC-U Ø110mm	100	110	-	-	-	0.1
0058	822 Drain union PVC-U Ø160mm	100	160	-	-	-	0.5
2638	922 Foul air trap PVC-U Ø160mm	-	160	-	-	-	1.9
7932	950 Roddable foul air trap MDPE Ø160mm	-	160	-	-	-	0.8

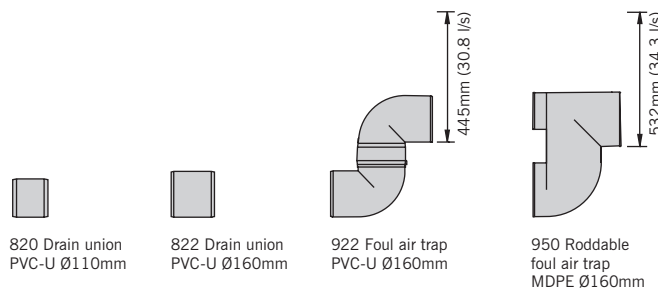

These products are subject to weight and dimensional tolerances. The dimensions shown on this page are for guidance purposes only.



ACO MonoDrain® PD150D

Multifunctional end cap

Product code	Description	Length (mm)	Width overall (mm)	Depth overall (mm)	Invert depth (mm)	Slot width (mm)	Invert Type	Weight (kg)
20801	MonoDrain PD150D Multifunctional endcap	3	200	315	-	-	-	0.24

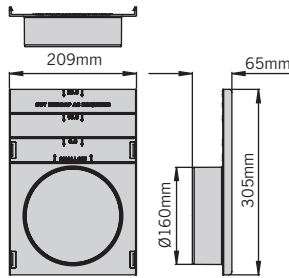

The multifunctional endcap can be cut down to suit all PD150D channels. See page 26 for further information.

Step Connector

Product code	Description	Length (mm)	Width overall (mm)	Depth overall (mm)	Invert depth (mm)	Slot width (mm)	Invert Type	Weight (kg)
20851	MonoDrain PD150D Step connector	120	150	40	-	-	-	1.12

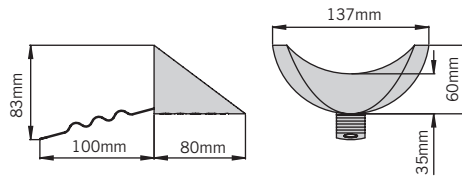

Note: For information on the step connector functionality see page 26.



ACO MonoDrain® accessories

Universal gully and components

Product code	Description	Length (mm)	Width overall (mm)	Depth overall (mm)	Invert depth (mm)	Slot width (mm)	Invert Type	Weight (kg)
33401	Gully assembly and bucket 601D	440	440	1315	870	10	-	52.5
33402	Gully assembly no bucket 602D	440	440	1315	870	10	-	51.0
33407	Gully top assembly 607D	440	440	655	-	10	-	45.0
33605	Gully base unit 605	-	Ø375	750	310	-	-	4.3
33603	Gully intermediate unit 603	440	440	515	-	-	-	5.1
44355	Gully grating and frame 600D	400*	564††	100	-	10	-	40.0
7060	Gully connector 615	500	Ø500	40	-	-	-	7.0
33606	Bucket polyethylene 606	-	Ø275	245	-	-	-	1.4

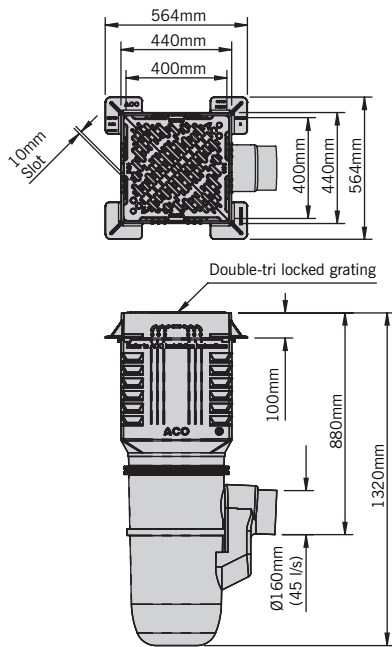

Product code: 33401 and 33402

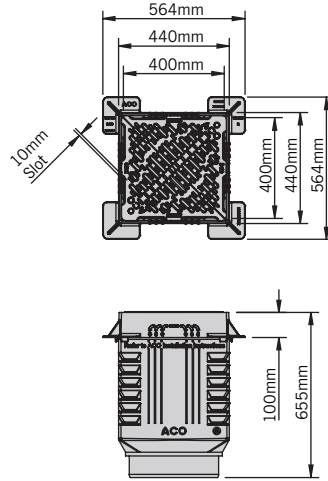

Product code: 33407

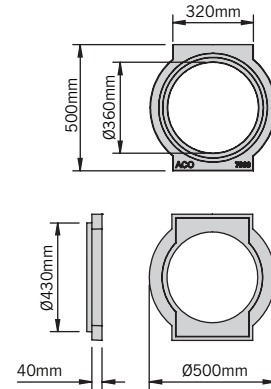

Product code: 7060

Polymer repair kit

Product code	Description	Weight (kg)
32599	Polymer concrete repair kit	1kg†



Polymer repair kit

Note. Plain U-PVC 150mm - 160mm Supersleeve adaptor supplied with 601D, 602D and 605 assemblies.

†Repair kit includes 0.5kg tin of natural colour polyester concrete repair resin, grey and black pigment, hardener paste, mixing instructions and material safety data sheets.

For information on universal gully functionality see page 27. *Clear opening size. ††Over frame size.

These products are subject to weight and dimensional tolerances. The dimensions shown on this page are for guidance purposes only.



Preparing the system for installation

This section provides guidance on the preparation steps that may be required for the installation of the ACO MonoDrain® system.

Access unit base pipe connection

All ACO MonoDrain® access units are supplied with a pre formed removable panel in the base for connection to either Ø110 or 160mm PVC-U pipes.

Drill Ø8mm holes around the circular recessed groove in the base of the unit so the drilled holes almost touch each other. Support the channel on sand or soft earth and with a chisel work around the recessed groove removing any remaining material. Once all the holes have been connected, the central panel can be removed. Use a chisel to tidy up any remaining material.



Push fit pipe into recess provided and seal as required. For recommended sealants and sealing procedure refer to the section headed "watertight sealing".



Access unit side wall connection

Removable side panels are provided on both sides of the access units marked with a 'J' in the parts table. This allows channel runs to be connected together to form "T" or "L" junctions for continuous water flow through the system.

Use a disc cutter to cut along the central recessed guides through the full thickness of material. Ensure cuts extend to but not beyond the perimeter recess surrounding the removable panel.



Use a chisel to remove segments of the panel and tidy up any remaining material.



Channel connection can now be made and sealed as required. For recommended sealants and sealing procedure refer to the section headed "watertight sealing".



Access units composite cover

All access units have a self-locking composite cover to provide an entry point to the system for inspection and jetting.



To open: Using a standard, medium duty drain lifting key, insert the key head through the keyway slot and press down.



Rotate the drain lifting key 90° - ensuring the key remain vertical



Lift the key and cover as a complete unit and remove from the frame. (If you wish to remove the key, hold the cover and twist the key 90°.

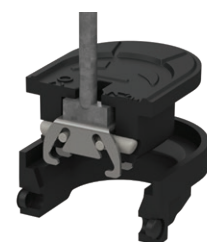

ACO's Polymer concrete repair kit is available for bonding applications, for instance where a mitred channel joint is to be made or for the repair of small areas of aesthetic damage.



Preparing the system for installation - continued

To Close: If the key is still in the cover, closing is the reverse of opening. If the key is not used see below.



To fit the cover in the frame, simply push the cover down onto the frame - The locking pins will retract and snap into place to lock the cover.

The steel crossbar will rise to the top to identify the cover is secure.



Fitting step connector

This unit is used between constant depth channel joints where a stepped fall installation is required. The step connector take up a 40mm height difference and ensures a smooth water flow within the channel system.



Place the step connector into the base of the deeper channel to be jointed as shown. If a watertight installation is required, seal around the step connector. For recommended sealants and sealing procedure refer to the section headed "watertight sealing". Push channel joint together to lock the step connector in place forming a smooth transition between units.



Multifunctional endcap

A Multifunctional endcap is provided for each channel width that is designed to be used with all channel heights. Manufactured from polypropylene these versatile endcaps can be adjusted on site to perform the function of a closing endcap or as an inlet/outlet endcap for connection to Ø110mm (100mm wide bore) or Ø160mm (150mm wide bore).

Cutting guide

Removable knockout panel



Multifunctional end cap used as a Closing endcap: The endcap supplied fits directly to the deepest channel within the system. All other channel heights can be accommodated by simply cutting the endcap to suit. A cutting guide is printed on the front of the endcap plate. The endcap is fastened to the channel by two clips and can be connected to either male or female channel end.



Adjusting endcap

Fitting endcap to channel

Multifunctional end cap used as an Inlet & Outlet endcap: The endcap has a knockout panel which can be removed with a hammer. Once fitted to the channel the endcap performs either an inlet or outlet function and is designed to provide a connection to Ø110mm (100mm wide bore) or Ø160mm (150mm wide bore).



Removing knockout panel Pipe connection to endcap

Watertight sealing*

ACO MonoDrain® channels are generally installed without a water seal. Once butt jointed and with a concrete surround a fairly watertight installation is achieved. If however a watertight system is required each ACO MonoDrain® channel is provided with a sealant groove allowing the system to be sealed by the application of a flexible sealant during installation. For rainwater applications we recommend a single component polyurethane based elastomeric joint sealant such as BASF Masterflex 472 or Sika Sikaflex 11FC or similar. Application of the sealant to be in accordance with the sealant manufacturers recommendations but, for guidance only, a typical method of application is as follows.

Jointing faces of the channels must be sound and clean. Remove all loose material, dust, oil and grease. This can be done by the use of a wire brush. Ensure jointing faces remain clean at all times (surfaces can be damp but no water droplets should be evident).

Apply sealant with a cartridge gun in a



10mm continuous bead following the groove provided on the end face of the channel to be sealed. Sealant should stand 5mm proud of the channel end face so that it will be compressed when the joint is closed.

Install the next cleaned channel by pushing the joint closed horizontally so as not to smear the sealant bead. Close the channel joint so there is no more than a 1mm gap between channels. Wipe away any excess sealant and leave to cure before use as per the sealant manufacturer's recommendations. Repeat steps as required.



*ACO MonoDrain® channels are tested to confirm compliance with the watertightness requirements of BS EN 1433 when filled with water to the top of the channel bore.



Connecting the sump unit

Two polymer concrete sump units are available for the two channel widths, and cater for all the channel heights in the range. It provides the capacity to hold silt and debris and multiple pipe connections to outlet to on-going pipework.

For pipe connections, remove the plastic Ø110mm and Ø160mm caps. Ensure seals are clean and free of debris before connecting pipework. A suitable pipe lubricant will make pipe connection easier.



Channel connection details can be removed using a sharp blade or saw, to the appropriate channel height. Cutting guide recessed grooves are provided and should be followed taking care not to cut beyond the areas to be removed.

Channel connection can now be made and sealed as required. For recommended sealants and sealing procedure refer to the section headed "watertight sealing".



Connecting roddable foul air traps

A drain connector in Ø160mm for connection to foul or combined drainage is available.



Ø160mm foul air trap

Foul air traps come complete with a removable bung for rodding and are manufactured from highly durable recyclable MDPE.



Bung can be removed for rodding.



Connecting the ACO Universal Gully

The ACO Universal Gully is a modular system designed for use with all channel widths and heights within the ACO MonoDrain channel system. The Universal Gully is provided with a lockable load class D 400 grating with Heelguard™ slots. The gully base provides silt retention and management for the channel system and outlet pipe connection to the on-going drainage network.

Once installed, the ACO Universal Gully can be cut to match channel depth as shown using a pad saw or similar. Use the shape of connecting channel bore as a cutting guide. Channel connection can now be made and sealed as required. For recommended sealants and sealing procedure refer to the section headed "watertight sealing".

Ductile cast iron hinged cover



Cutting guide to suit most ACO channels



Silt bucket



Gully base including roddable foul air trap

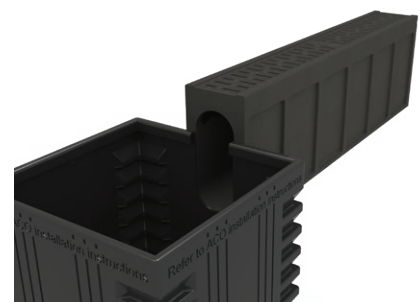

Installation detail

ACO MONODRAIN®

Asphalt pavement

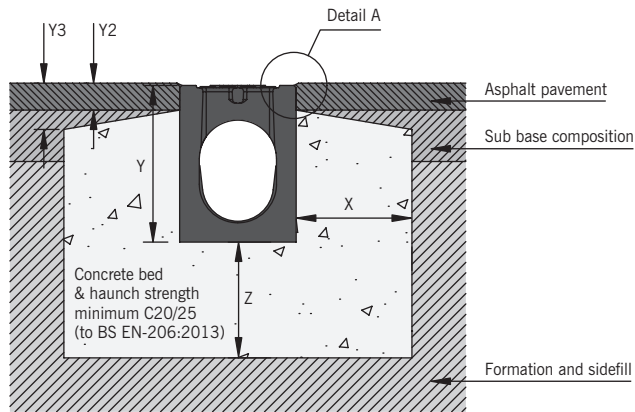

Concrete pavement

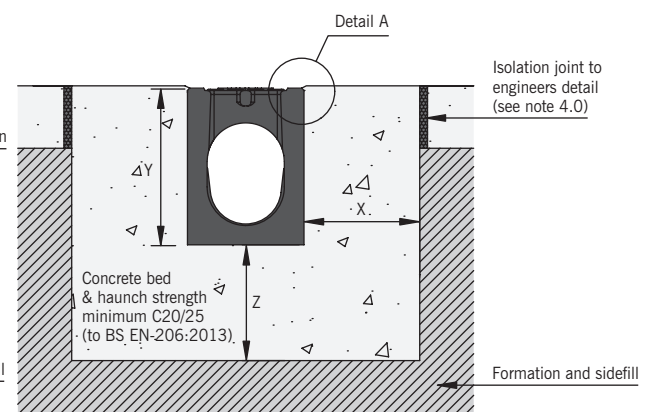

1.0 Load Class

Installation recommendations shown are ACO minimum recommendations for BS EN 1433:2002 load class requirements.

2.0 Ground Conditions

The long term performance of a channel installation to sustain vertical and lateral loads depends upon A) ground conditions B) stability of the adjacent pavement and C) a durable concrete bed and surround. The recommended installation detail may require the minimum dimensions to be revised to achieve site specific load class requirements (referred to in 1.0 above).

3.0 Cutting and Jointing

Mitre joints are formed by cutting the channels to the required angle and butting them together with appropriate sealant (e.g. Sikaflex 11FC or similar) or ACO Repair Kit. Where possible 90° joints and T's should be formed so that gratings do not have to be cut. Angles can be formed by connecting them using proprietary PVCu pipework attached to ACO inlet/outlet endcaps. For further details please contact ACO Design Services Team.

Note: For Load Classes higher than C 250, mitred joints are not recommended in vehicular areas. Where requested ACO can custom manufacture angled junctions to order.

4.0 Isolation Joints

The channel must be isolated from the surrounding environment. An isolation joint must be positioned up to 1500mm from the channel wall. Any dowel bars must be located no nearer than 150mm from the channel wall. Other isolation joints in surrounding slab must be continued through the channel.

Additional crack control may be required to comply with specifier requirements.

5.0 Installation into in-situ Slab

Where a channel is to be installed into an existing concrete slab it is necessary to cut a suitably sized pocket in the slab. The channel will then need to be bedded in polymer modified mortar of 25mm minimum thickness (this may vary depending on the type of mortar used). Engineering advice may be necessary.

6.0 Temporary Installation

A channel installation is not complete until the final surfacing is laid. In any temporary condition, i.e. with the channel walls projecting above adjacent ground, site traffic should not cross channels. Loose boards, stone fill or cover plates will not protect the channel walls or grating. A temporary channel crossing should be formed by raising the ground level locally, to 3 - 6mm above top of edge rail, either side of a channel for a distance of 750 to 1000mm, to form ramps. Note that the channel load class should be adequate to carry the site traffic.

7.0 Block Pavements

The channel must be supported laterally. Blocks laid directly against a channel must be laid as a soldier course and restrained from movement by bedding securely on the concrete haunch e.g. by using a polymer modified mortar for bed and perpendicular joints (e.g. RONAFIX mortar mix C or similar). Blocks or slabs bedded on sand remote from the channel should be set at a higher level to compensate for possible settlement of the paving in service.

A 15 or B 125 for 0.0 and shallow PD100D installations incorporating block paving do not require a concrete haunch or polymer modified mortar. Ensure sub-straight is firmly compacted to ensure channel and paving are secure from movement.



Block pavement options 1 and 2

Detail A

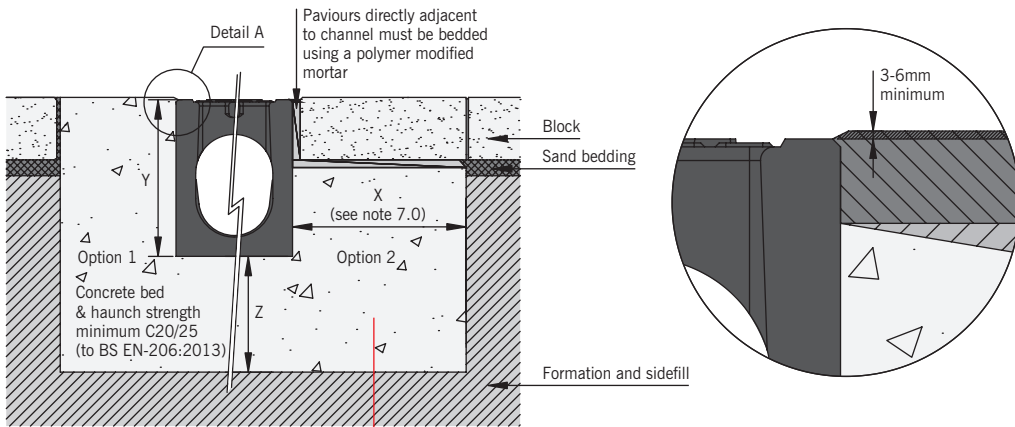

A 15 and B 125 installation savings -see note 7.0

8.0 Access Unit Locking System

Composite plastic access unit cover should be securely pressed into place, until the locking mechanism engages

9.0 Channel Protection

Avoid contact between compaction equipment and top of ACO channel edge rail. The installer must ensure that the finished surface level lies above the top of the edge (by at least 3-6mm). Covering or protecting the grating, before concreting the haunch or laying blocks, removes the time and cost associated with cleaning the channel and grating of cement material and embedded stones.

10.0 Watertight Installation to BS EN 1433:2002

Where ACO channel joints/fittings and channel/pavement interfaces are to be sealed, an appropriate sealant should be used (e.g. Sikaflex 11FC or similar). Guidance on the necessary surface preparation and/or priming should be sought from the sealant manufacturer.

These details are available to download in DWG or PDF format from the ACO website. Please go to www.aco.co.uk and sign in or register to access this information.

Best practice and workmanship

ACO can give guidance with respect to the most suitable methods of installation for each of the products in the ACO MonoDrain® range. ACO MonoDrain® should be installed using acceptable levels of workmanship and according to the National Code of Practice (UK: BS8000: Part 14: 1989) in keeping with EN 1433:2002 (Drainage channels for vehicular and pedestrian areas).

Detailed installation statements and methodologies will vary for all sites as each will have different aspects deserving particular consideration, consequently the relevant approvals should be sought from the consulting engineer and/or the installer.

For further information please contact our Design Services Team (technical@aco.co.uk) or the ACO website www.aco.co.uk.

11.0 Minimum Dimensions of Concrete Surround

Load Class	D400*	
Minimum dimensions (mm)	X	100
	Y	Full channel height (Less Y2 where applicable)
	Z	100
Maximum Dimensions (mm)	Y1	35
	Y2	60

*E.g. Parking areas for all types of road vehicle. Not suitable for carriageway of roads or industrial areas.



Design Software

ACO QuAD Hydraulic Design Software

TRY OUR FREE DESIGN TOOL

The new free-to-use ACO QuAD Hydraulic Design software has unprecedented levels of choice and flexibility built-in, to enable the efficient and accurate hydraulic design of any surface water management scheme.

The hydraulic engine has been robustly tested and is the tool used by ACOs own internal Design Services team in modelling surface water solutions for customers.

ACO QuAD Hydraulic Design software uses differential equations for spatially varied flow that online alternative solutions cannot accurately match. For example the Manning's equation for steady uniform flow does not work with level channels and is grossly inaccurate on shallow gradients.



Here are some of the features it includes:

- Powerful project-based software
- Create catchment models that are fully editable
- PDF summary document output
- Cloud based – All designs are stored securely on our server against your login
- Integrated rainfall data for the whole of the UK

To use the QuAD Hydraulic Design software visit: www.aco.co.uk/quad-hydraulic-design-2.0

QUAD FEATURES OVERVIEW

Cloud based

The software means increased efficiency providing design resources you need when you need it, allowing you to deploy the same design capability consistently, with the same consistency in results every time.



Flexible download format

Output can be generated for all or parts of the project and can be generated in pdf or CSV formats.



Secure scheme filing

All designs created by registered users are stored on a secure server and are password protected. Past projects are easily retrieved from the personalised menu.



Flexible catchment design

QuAD is designed to support designers in the creation of catchment areas. Supplementary catchment areas can easily be added upstream and downstream of any previously designed channel run.



Application

Application selection ensure designers are able to get quick and accurate guidance in selection of the most suitable products based on the type of application the catchment is to cater for.



Knowledge database

There is support available either through a query submission or through self-help made possible by the comprehensive Knowledge database.



Product optimiser

Optimising the specific channel runs can be done with the optimiser feature selecting the smallest product suitable. Excavation and concrete requirements are also provided.



Rainfall assist

Rainfall intensity by location matters in design. QuAD provides a site locator map enabling the most accurate intensity to be input.



Resilience assessment

By inputting anticipated sedimentation rates and sedimentation density the QuAD software enables the designer to test their suggested maintenance schedules.



Attenuation assessments

Calculate the attenuation required for the project and compare it with the storage available in the channel design. Attenuation volume is presented along with suitable options for storage.



Register Now - It's Free
www.aco.co.uk/quad-hydraulic-design-2.0



Design Support Services

Surface water management system design can often be a complex task. Success in combining products and processes requires a thorough understanding of how these different elements work together.

The ACO Design Services Team is able to work closely with you through the entire design process to ensure accurate and cost-effective product selection is made.

Services we offer include (free and without obligation):

- Whole system design, from collection to the attenuation of surface water
- Hydraulic calculations and AutoCAD detailing
- Parts schedules

ACO has embraced the concept of value engineering as an approach to on-site construction that saves both time and money.

ACO will review any design to minimise the total scheme and life cost of a proposal. The team can suggest the most appropriate range depending on your requirements.

Some ranges like MultiDrain or MonoDrain allow water to be contained and conveyed close to the surface, which accords with the principles advocated for Sustainable Drainage (SuDS Manual, 2015), by removing the need for pumping. Other ranges like Qmax allow attenuation – the storage of large volumes of water during storm events, reducing overall site costs.

For detailed designs using the ACO Hydraulic Design Software, please contact the ACO Water Management Design Services Team.

If manual calculations are preferred to using our QUAD software, hydraulic tables and instructions for manual calculations can be provided.

ACO Water Management Design Services Team

Tel: 01462 816666

Email: technical@aco.co.uk

ACO BIM MODELS

BIM is the process of generating and managing data, and developing collaborative behaviours that will unlock new and more efficient ways of working at all stages of the project life-cycle. These files will help contractors specify and optimise drainage systems in line with the overall benefits of BIM-enabled

working, including faster project delivery, reduced costs, reduced waste and greater project predictability.

Depending on the product range Civils3D, IFC or Revit files are available for download.

www.aco.co.uk/aco-bim-models

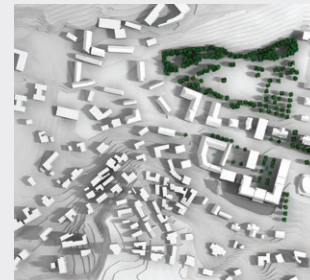

Professional Development

Helping create knowledge champions

In today's ever-changing construction industry, it has never been more important to ensure you are up to date with current industry trends and new innovations. Surface water management is one of the most dynamic sectors of the construction industry with new legislation, innovative products and ground-breaking materials constantly emerging.

Depending on your professional body or employer, you may be required to undertake between 20 and 30 hours CPD per year. ACO understands this can be a daunting task and has developed a series of professional

development courses that can be accessed in a number of ways including online, in-office or at our state-of-the-art training facility at ACO UK office headquarters in Bedfordshire.

The courses have been carefully developed to provide essential learning and knowledge and are delivered by ACO's UK wide experienced Business Development Team ensuring that only the highest quality content is delivered.



To find out more and book a professional development course, visit: www.aco.co.uk/professional_development



Chemical resistance chart

Vienite®, ACO's sustainable high strength material, has a high resistance to dilute acids and alkalis, and are unaffected by road salt, fuel and oil, and other commonly encountered chemicals. Further details of the chemical resistance can be obtained from the ACO Water Management Design Services team or, for particular chemicals, samples of the polymer concrete can be supplied to customers for their own testing. The chemical resistance will also depend on the temperature of the effluent. Clean water should not exceed 80°C.

This chemical resistance chart refers to chemicals at ambient temperatures (20°C) and the results are for general guidance only.

Chemical medium	% conc	Resistance: Vienite®
Acetic acid, glacial	100	No
Acetic acid	10	Yes
Acetic anhydride	100	No
Acetone	10	No
Acetone	100	No
Alum	100	Yes
Aluminium sulphate	100	Yes
Ammonium chloride	100	Yes
Ammonium nitrate	100	Yes
Ammonium phosphate	65	Yes
Ammonium sulphate	100	Yes
Aniline (aminobenzene)	100	No
Barium chloride	100	Yes
Benzaldehyde	100	No
Benzene	100	No
Benzyl alcohol	100	Yes
Benzyl chloride	100	No
Borax	100	Yes
Boric acid	100	Yes
Bromine	100	No
Bromine water	Saturated	No
Butyl acetate	100	No
Butyric acid	100	Yes
Calcium carbonate	100	Yes
Calcium chloride	100	Yes
Calcium chlorate	8	Yes
Calcium hydroxide	100	Yes
Calcium nitrate	100	Yes
Carbon disulphide	100	No
Carbon tetrachloride	100	Yes
Castor oil	100	Yes
Chlorine gas, wet	100	No
Chlorine water	Saturated	No
Chlorobenzene	100	Yes
Chloroform (trichloro-methane)	100	No
Chromic acid	12	Yes
Citric acid	100	Yes
Copper chloride	100	Yes
Copper nitrate	100	Yes
Cyclohexane	100	Yes
Diesel fuel (DERV)	100	Yes
Dimethyl formamide	100	No
Dimethyl phthalate	100	Yes
Diocetyl phthalate	100	Yes
Ethanol	95	No
Ethanolamine	100	Yes
Ethyl acetate	100	No
Ethylene glycol	100	Yes
Ferrous chloride	100	Yes
Ferric chloride	100	Yes
Ferrous sulphate	100	Yes
Formaldehyde	30	Yes
Formic acid	10	Yes
Formic acid	100	No
Fuel oil	100	Yes
Gasoline	100	Yes
Glycerine	100	Yes
Hydrazine	50	No

Chemical medium	% conc	Resistance: Vienite®
Hydrobromic acid	48	Yes
Hydrochloric acid	10	Yes
Hydrofluoric acid	10	No
Hydrogen peroxide	30	Yes
Lactic acid	100	Yes
Lead acetate	100	Yes
Magnesium chloride	100	Yes
Magnesium sulphate	100	Yes
Maleic acid	100	Yes
Methyl ethyl ketone (MEK)	100	No
Motor oil	100	Yes
Nickel chloride	100	Yes
Nickel sulphate	100	Yes
Nitric acid	5	No
Nitrobenzine	100	No
Oleic acid	100	Yes
Oxalic acid	100	Yes
Perchloric acid	10	Yes
Perchloroethylene	100	Yes
Phosphoric acid	20	Yes
Phosphorus trichloride	100	No
Potassium carbonate	50	Yes
Potassium chloride	100	Yes
Potassium dichromate	100	Yes
Potassium hydroxide	10	Yes
Potassium nitrate	100	Yes
Potassium permanganate	10	No
Potassium sulphate	100	Yes
Pyridine	100	No
Sodium acetate	100	Yes
Sodium bromide	100	Yes
Sodium carbonate	35	Yes
Sodium chlorate	100	Yes
Sodium chloride	100	Yes
Sodium hydroxide (caustic soda)	50	No
Sodium hypochlorite	18	No
Sodium nitrate	100	Yes
Sodium nitrite	100	Yes
Sodium phosphate	10	Yes
Sodium sulphate	100	Yes
Sodium sulphide	100	Yes
Sodium sulphite	100	Yes
Sodium thiosulphate	100	Yes
Stearic acid	100	Yes
Styrene	100	No
Sulphuric acid	75	No
Sulphuric acid	50	Yes
Sulphuric acid at up to 40°C	10	Yes
Tetachloroethylene	100	Yes
Thioglycolic acid	80	Yes
Thionyl chloride	100	No
Toluene	100	Yes
Toluene sulphonic acid (aqueous solution)	Saturated	Yes
Trichloroacetic acid	50	Yes
Turpentine	100	Yes
Water	100	Yes
Xylene	100	Yes
Zinc sulphate	100	Yes



Model specification clause

The channel drainage system shall be ACO MonoDrain (Insert channel description e.g. ACO PD100D) channel system as supplied by ACO Technologies plc. All materials and components within the scope of the system shall be supplied by this manufacturer. The channel units shall be fully compliant with BS EN 1433:2002 load class D 400 with Initial Type Test certification issued by a notified body independent of the manufacturer. The channel units are to be CE marked in accordance with the Construction Products Regulation with Declaration of Performance certification issued by the manufacturer.

All units shall be one piece manufacture from Vienite® resin concrete with a minimum recycled content of 20% by weight. Water inlet design shall be Heelguard™ with under 10mm wide slots. The standard units shall be installed with the manufacturer’s components only as required for the scheme.

The system shall be installed in accordance with the manufacturers printed recommendations, and works carried out as specified on drawings* and in accordance with recognised good practice. Standards of workmanship shall generally be as specified in BS EN 752 and BS 8000: Part 14:1989.

*Please insert relevant drawing number

NBS specification

ACO MonoDrain® should be specified in NBS Section Q10:180. Assistance in completing this clause can be found in ACO Technologies product entries in NBS Plus or a model specification can be downloaded from www.aco.co.uk. For further assistance, contact the ACO Water Management Design Services Team.

Conformity

The MonoDrain® system is CE marked in accordance with the Construction Products Regulation.

Declarations of Performance are available via the CPR Zone on our website, or on request. Please contact ACO Water Management Design Services Team on 01462 816666 for further assistance.

BS EN 1433:2002



ACO Technologies plc

- ACO Water Management
Civils + Infrastructure
Building + Landscape
- ACO Building Drainage
- ACO Sport
- ACO Wildlife

Member of:



ISO 9001
FM 13502



ISO 14001
EMS 538781



OHSAS 18001
OHS 524145

ACO Water Management

A division of ACO Technologies plc
ACO Business Park,
Hitchin Road,
Shefford,
Bedfordshire
SG17 5TE

Tel: 01462 816666

Fax: 01462 815895

e-mail Enquiries: awmenquiries@aco.co.uk

e-mail Sales: customersupport@aco.co.uk

e-mail Technical: technical@aco.co.uk

website: www.aco.co.uk

ACO. creating the future of drainage

© April 2019 ACO Technologies plc. All reasonable care has been taken in compiling the information in this document. All recommendations and suggestions on the use of ACO products are made without guarantee since the conditions of use are beyond the control of the Company. It is the customer's responsibility to ensure that each product is fit for its intended purpose, and that the actual conditions of use are suitable. This brochure and any advice is provided by ACO Technologies plc (the Company) free of charge and accordingly on terms that no liability including liability for negligence will attach to the Company or its servants or agents arising out of or in connection with or in relation to this brochure or any such advice. Any goods supplied by the Company will be supplied solely upon its standard conditions of sale, copies of which are available on request. The Company's policy of continuous product development and improvement renders specifications liable to modification. Information provided in this brochure is therefore subject to change without prior notification.