

ONDULINE® Classic sheets®

The attractive durable lightweight corrugated sheet roofing system

Design and installation manual

Complementary leaflet to the Onduline instructional film available online



www.onduline.co.uk

Onduline fixing guide:

This guide provides comprehensive design and installation guidance, you can either select & click on the specific information you require from the index below or view this guide and instructional video in full.

Contents:

- 01 Introduction**
 - Onduline sheet specification
 - Identifying top surface of sheet
- 02 Roof design**
 - Roof structure
 - Roof types and terminology
 - Recommended tool kit
- 03 Roof construction**
 - Roof support options
 - Support to sheet
 - Sheet laps
 - Fixings to sheet
 - Sheet coverage
- 04 Preparation**
 - Setting the roof out
 - Fixing purlins or decking
 - Insulation and underlays
- 05 Fixing skills**
 - Marking out sheets
 - Cutting with handsaw
 - Cutting with power saw
 - Cutting with tinsnips
 - Cutting up length of sheet
- 06 Onduline fixing types**
 - Plastic capped nails
 - Safetop nails / screws
 - Universal drill screw fixing
- 07 Fixing sheets**
 - Sheet side and end laps
 - Corrugation end laps
 - Corrugation side lap
 - Sheet selection
 - Sheets laid in broken bond
- 08 Fixing details:**
 - Eaves detail.
 - Eaves / verge detail
 - Eaves tray option
 - Ventilator comb
 - Corrugation filler
- 09 Verge detail**
 - Nailed verge
 - Lapped verge
 - Onduline verge pieces
- 10 Ridge duo pitched roof**
 - Ridge purlin positioning
 - Onduline ridge piece fixing
 - Ridge trimmed laps option
 - Ridge finial
- 11 Ridge mono pitch roof**
 - Using Onduline verge piece
 - Ridge verge abutment
 - Using Onduline ridge piece
- 12 Wall cladding rainscreen**
 - Cladding options
- 13 Valley detail**
 - Valley support structure / lining
 - Marking sheet to valley
 - Cutting and positioning sheet
 - Valley saddle detail
- 14 Hip detail**
 - Hip support structure
 - Fitting sheet to hip
 - Laying ridge pieces to hips
 - Hip ridge abutment
 - Trimming hip ends
- 15 Onduline roof window**
 - Fixing roof window
- 16 Onduline roof ventilators**
 - Fixing roof ventilators
- 17 End wall abutments**
 - Fixing end wall abutment
 - Cover flashing
- 18 Side wall abutment**
 - Fixing end wall abutment
 - Cover flashing
- 19 Curved roof application**
 - Support structure
 - Fixing sheets to curve
 - Sheet laps on curved roof
- 20 Onduline Plastics**
 - Sheet selection
 - Eaves detail
 - Sheet fixings
- 21 General design notes**
 - Onduline design notes
- 22 Roof overshooting system**
 - Warm roofs
 - Cold roofs
 - Ondutile tile underlay system
- 23 General design notes**
 - Onduline

Onduline® Classic

Corrugated bituminous sheet roofing and cladding system



A tradition of quality

The Onduline Group is the worlds largest producer of bituminous corrugated roofing products, selling to over 120 countries worldwide.

Onduline classic sheet specification (nominal)

- Sheet size: 2.000 x 0.950 m
- Corrugation size: 95 x 38 mm
- Thickness: 3 mm (nominal)
- Lightweight: 6.4kg per sheet (nominal)
- BBA Product Certification
- Easy to handle, cut, shape and fix
- 15 year weather proofing guarantee subject to terms and conditions
- Excellent colour retention properties
- Withstands windspeeds of up to 120mph (192kph).
- Lightweight, only 6.4 kg per sheet
- High thermal and sound insulation
- Does not rust, or contain Asbestos
- ISO 9001:2008 Quality Management Standard
- ISO 14001: 2004 Environmental Management



Identifying top surface of sheet

Take care to fix Onduline sheets the correct way up, the underside is easily identified by its dimpled rough surface finish, whilst the top of the sheet has a smoother textured finish

Warning: Check that your sheet and accessories are genuine Onduline products. Failure to do so can result in lower quality roof performance and invalidate the Onduline roofing system guarantee.



Upper sheet surface



Lower sheet surface

Roof design:

Roof structure

It really is worth taking the time to first check your roof and carefully set out the design for the support structure on your project.

It will save you time and money!

New build project:

Just follow the information in this leaflet to create a durable low maintenance roof.

Existing roofs:

Survey your roof structure as this will allow you to decide if it requires maintenance, upgrading or strengthening prior to fixing the Onduline sheets. Make note of the roof construction normally built using purlins or boarded roof deck laid onto a timber portal or trussed rafter roof structure.

Warning: Check that existing purlins are fixed at centres suitable for fixing Onduline sheets onto; as many existing roofs do not offer sufficient support and failure to increase the support structure can result in sheet deformation and a significant shortening of the roofs service life.

Roof framing & design:

Rafter or trussed roof construction:

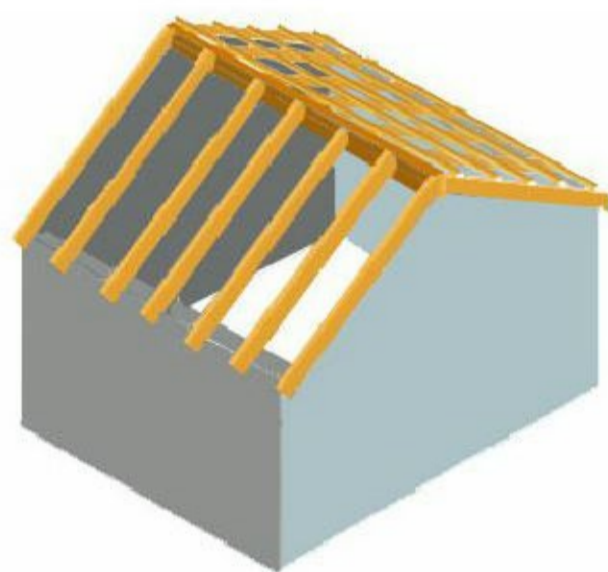

Portal framed roof construction supporting purlins:

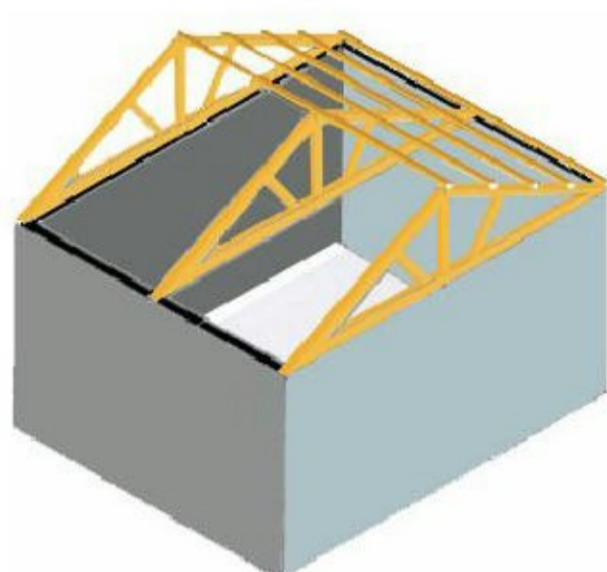

Conventional trussed roofs:

Roof design is based on triangulated frames which can be in the form of traditional framed structures or constructed from trussed roof frames.

Portal framed roof structures:

Timber frame structures often use a portal frame construction which supports purlins to which the roof covering material is affixed.

Roof types and terminology

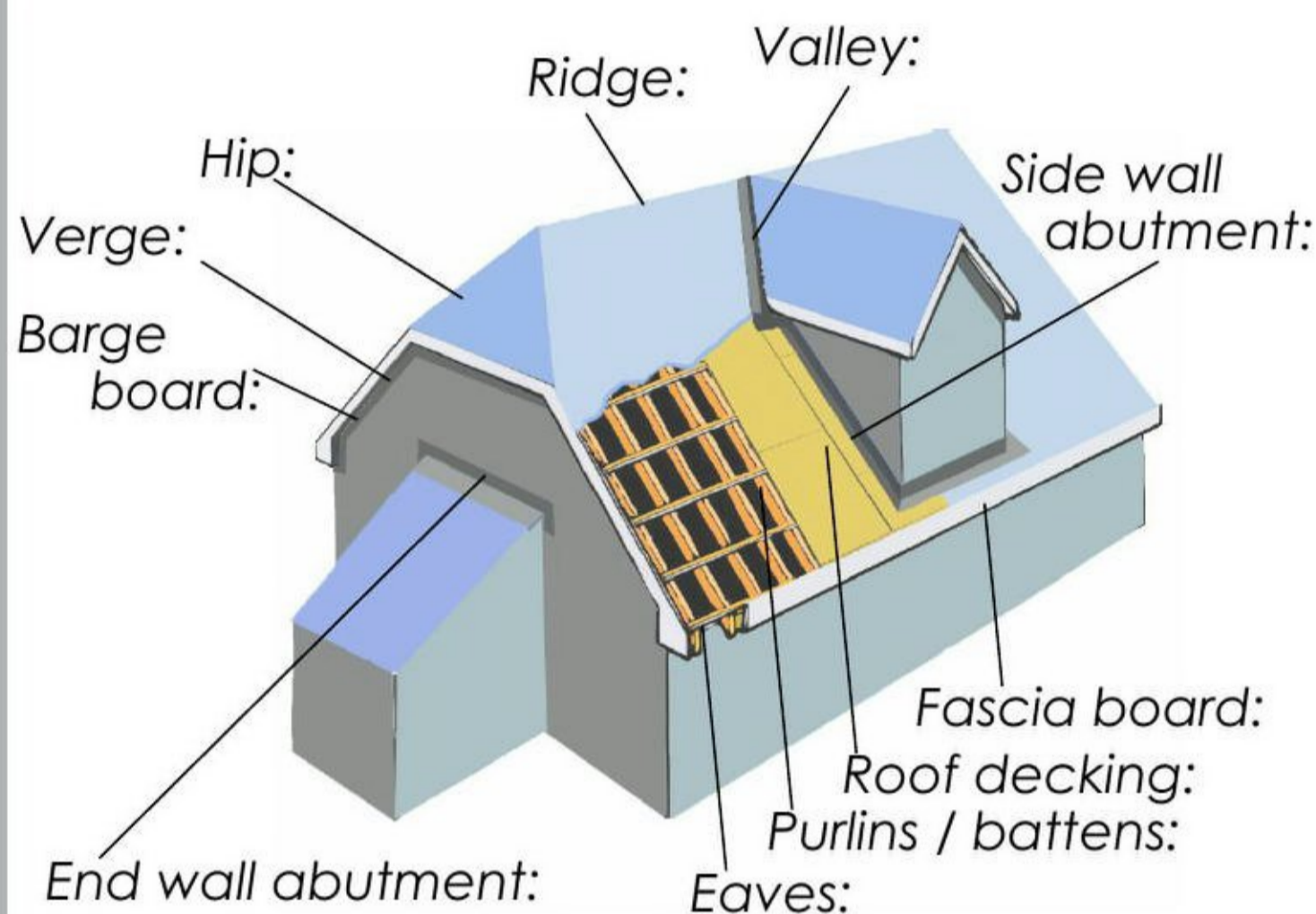
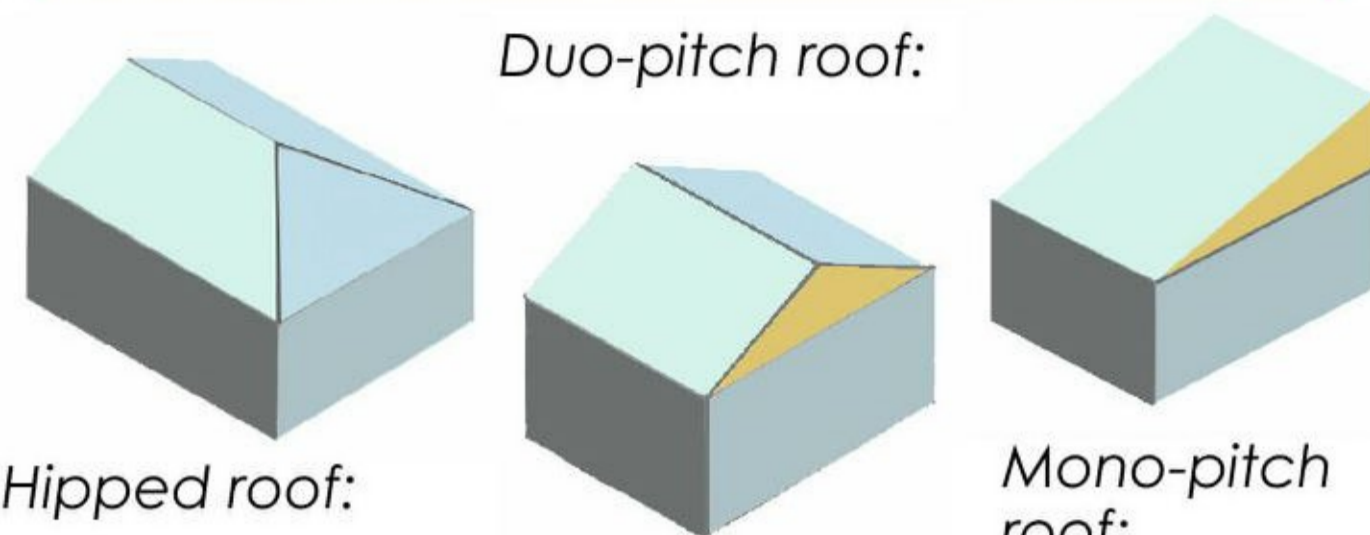

Recommended tool kit

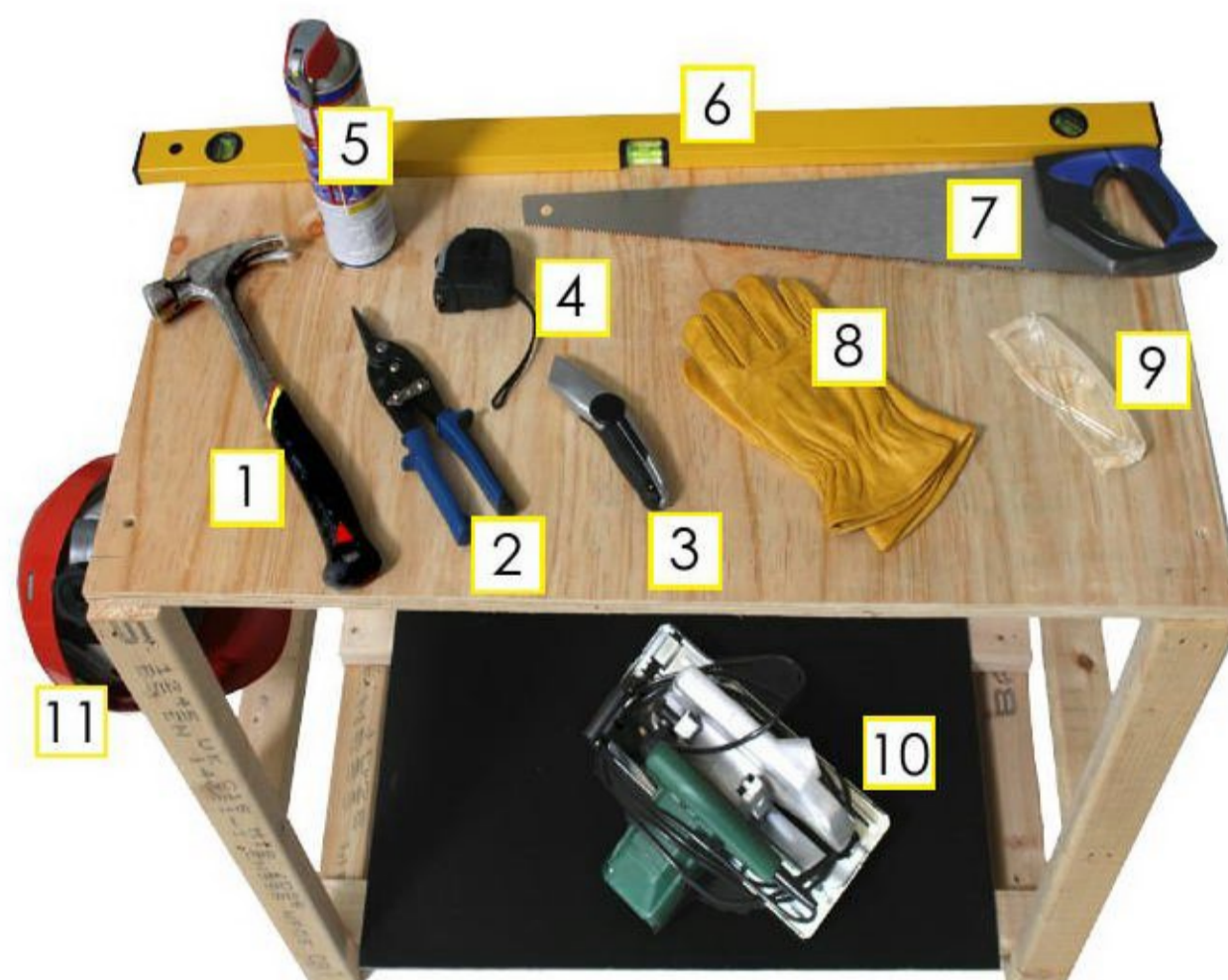

- | | |
|--------------------------|----------------------------------|
| 1 Hammer: | 7 Course bladed hand saw: |
| 2 Tin snips: | 8 Protective gloves: |
| 3 Roofers knife: | 9 Protective glasses: |
| 4 Tape measure: | 10 Electric rotary or skill saw: |
| 5 Spray lubricating oil: | 11 Protective hard hat: |
| 6 Straight edge: | |

[Return to Contents](#)

Onduline

Introduction

Fixing Onduline sheets is a simple process just follow the simple three step instructions set out in the tables below:

Roof support and fixing specification

- 1** Step 1: **First measure the slope of your roof:** To do this simple use a protractor or inclinometer or alternatively calculate the roof slope using the roof slope gradient.
- 2** Step 2: **Select one of the three fixing options set out below that matches the slope of your roof either: a: b: or c:**
- 3** Step 3: **Then just follow the fixing instructions described below the appropriate fixing option; a: b: or c:** They detail the correct support required below the sheets, corrugation end and side laps and finally the sheet fixings.

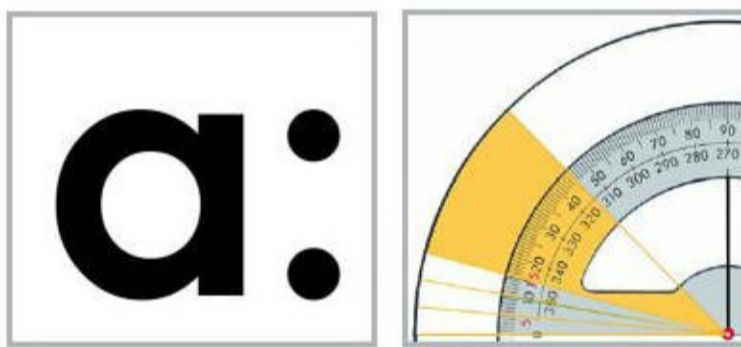

15° degrees or greater

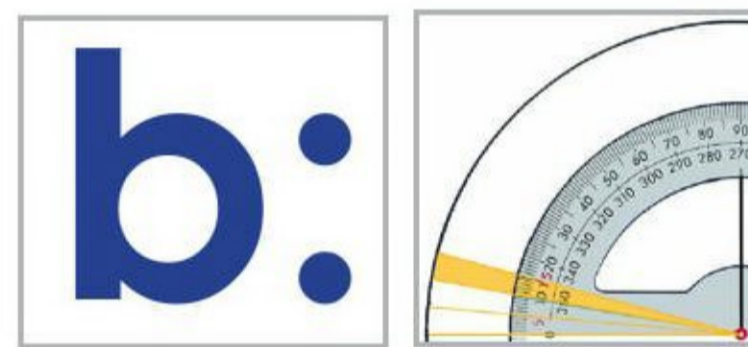

10 to 15° degrees

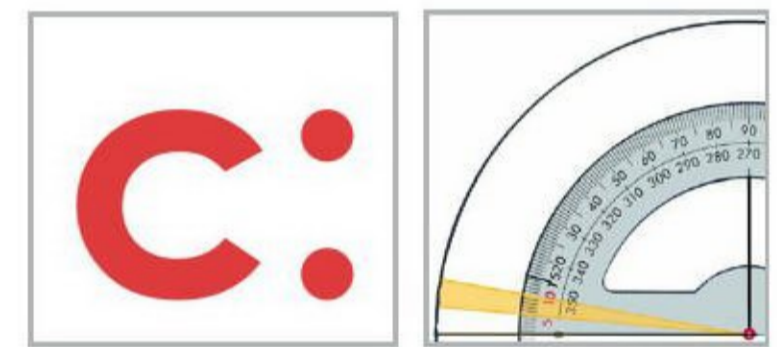

10 to 5° degrees

Support to sheets



Purlins should be fixed at maximum centres of 61 cm.
At the eaves allow for a 50cm sheet overhang when positioning the first purlin from the eaves.

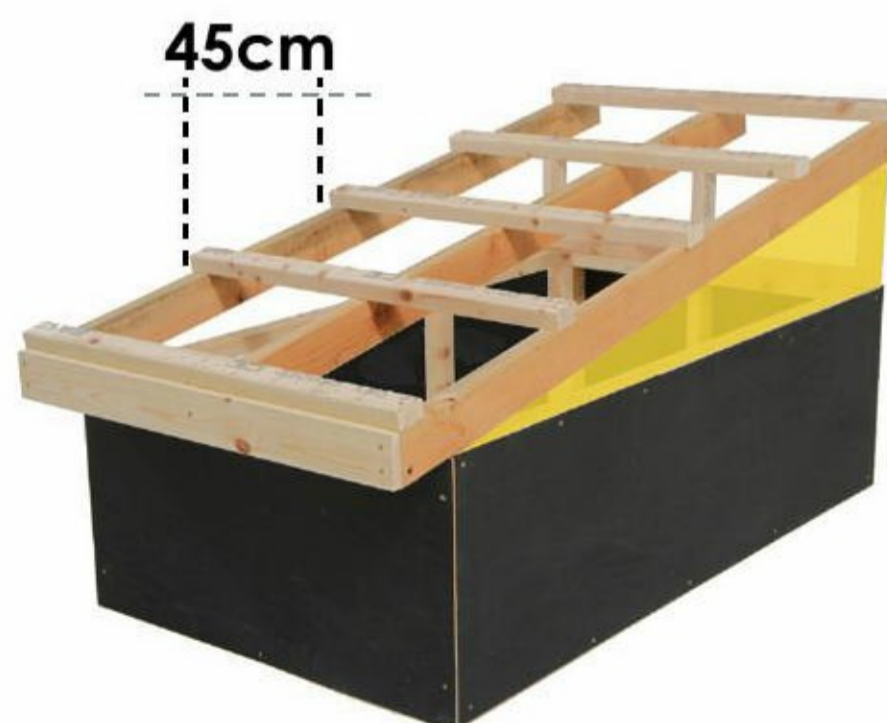

Purlins should be fixed at maximum centres of 45 cm.
At the eaves allow for a 50cm sheet overhang when positioning the first purlin from the eaves.

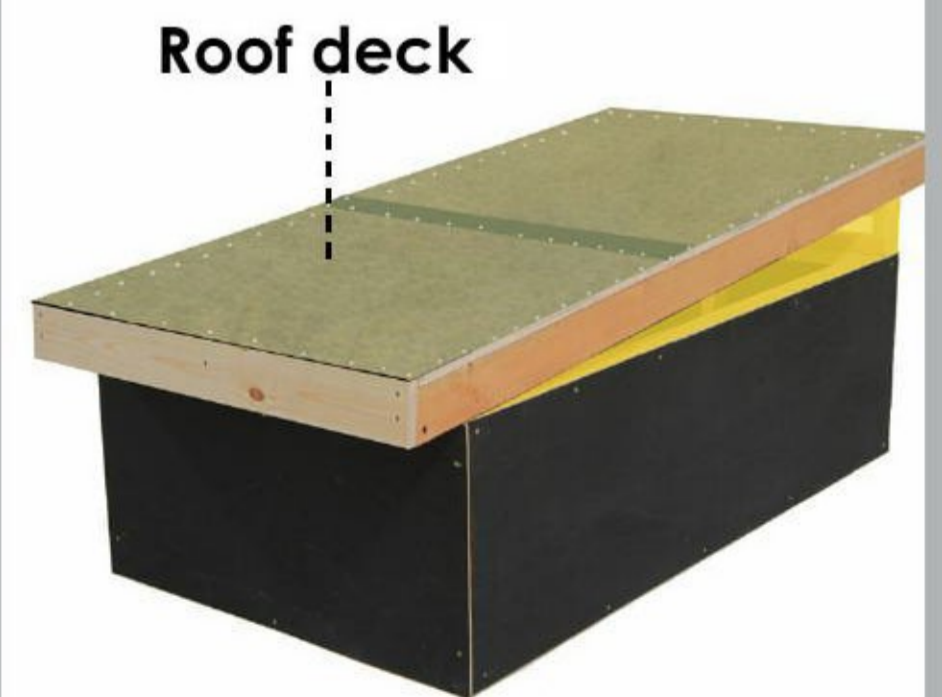

A fully supporting decked roof should be laid.
At the eaves allow for a 50cm sheet overhang when positioning the first purlin from the eaves.

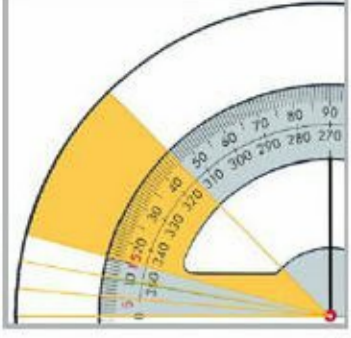
a: 

15° degrees or greater

b: 

10 to 15° degrees

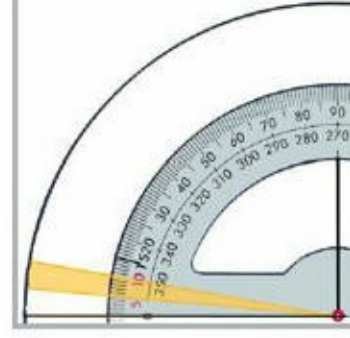
c: 

10 to 5° degrees

Sheet laps

 **Sheet end lap 17 cm**

 **1 Corrugation side lap**

Lay the sheets with:
17cm sheet end lap
Single corrugation side lap

 **Sheet end lap 20 cm**

 **1 Corrugation side lap**

Lay the sheets with:
20cm sheet end lap
Single corrugation side lap

 **Sheet end lap 30 cm**

 **2 Corrugation side lap**

Lay the sheets with:
30cm sheet end lap
Double corrugation side lap

Sheet fixings



Nail every corrugation along of the eaves, either side of the vertical laps and every other corrugation on the intermediate purlins in a offset pattern.



Nail every corrugation along of the eaves, either side of the vertical laps and every other corrugation on the intermediate purlins in a offset pattern.



Nail every corrugation along of the eaves, either side of the vertical laps and every other corrugation on the intermediate purlins in a offset pattern.

Sheet coverage

Sheet size: 2.000 x 0.950 m
Corrugation: 95 x 38 mm
Fixings per sheet: 20

Sheet coverage: 1.56 m²
Sheet cover length: 1,830 m
17cm sheet end lap
Sheet cover width: 0.855 m
One corrugation side lap

Sheet size: 2.000 x 0.950 m
Corrugation: 95 x 38 mm
Fixings per sheet: 25

Sheet coverage: 1.54 m²
Sheet cover length: 1,800 m
20cm sheet end lap
Sheet cover width: 0.855 m
One corrugation side lap

Sheet size: 2.000 x 0.950 m
Corrugation: 95 x 38 mm
Fixings per sheet: 20

Sheet coverage: 1.29 m²
Sheet cover length: 1,700 m
30cm sheet end lap
Sheet cover width: 0.760 m
Two corrugation side lap

Preparation:

Setting the roof out

Fix sheets at the opposite end of the roof from the prevailing winds. Then commence every other sheet course with a half sheet forming a broken bond sheet layout to avoid a 4 ply sheet thickness at sheet corners.

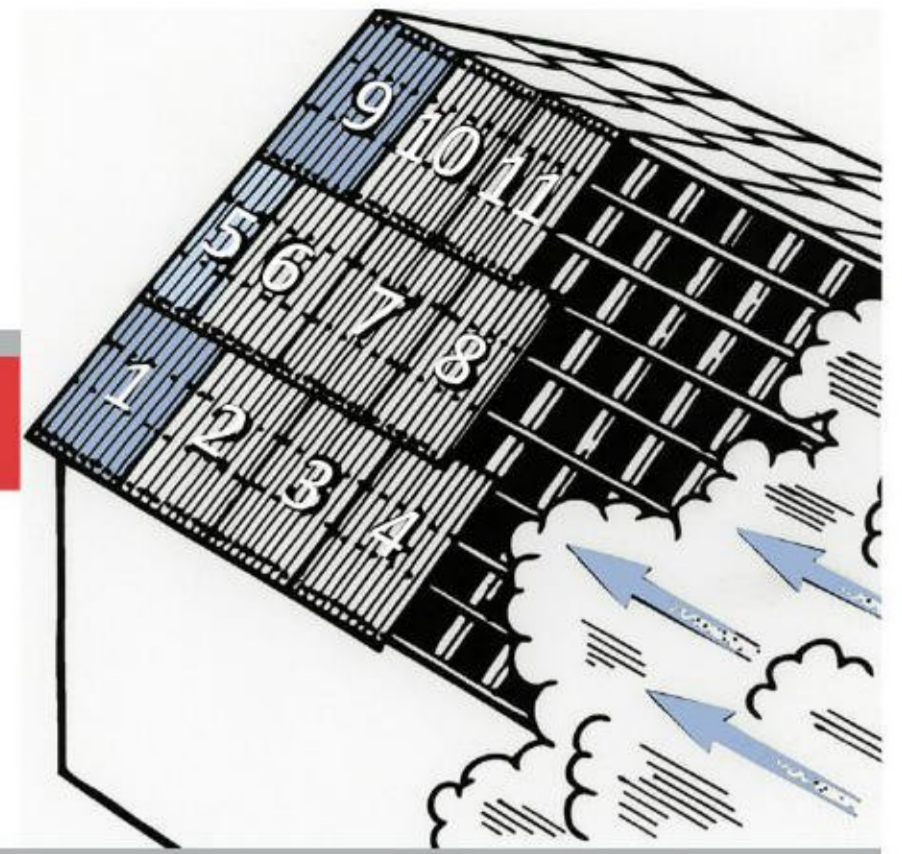

Fixing purlins or decking



Purlin size

Purlins must be of sufficient size to give support between the rafters. Consult the table on page 19 for guidance on the size of purlins required.

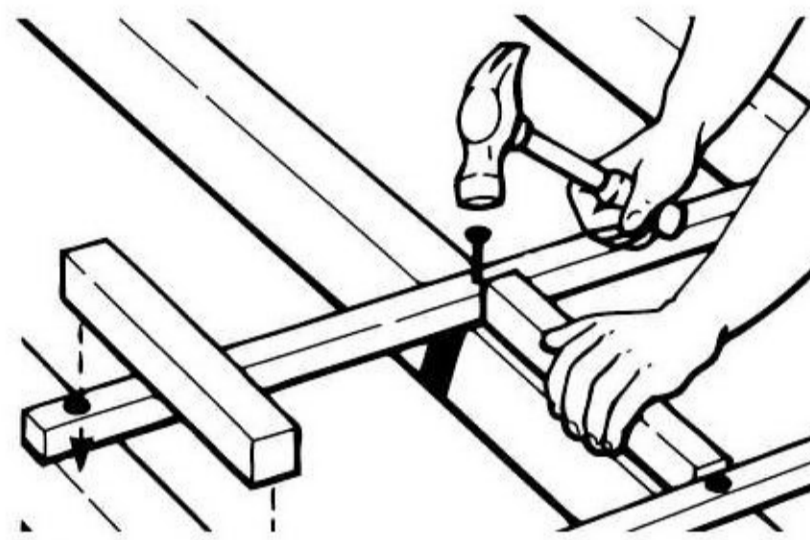

Fixing Purlins

Take care to set the purlins out to the correct centres and then either nail or screw them to the trusses or rafters.



Fixing decking

Decking should be laid in a broken bond pattern fixed to a minimum of three purlins in accordance with the relevant B.S. and Codes of Practice.



Fixing to existing deck

Check the thickness of the deck. You will need at least a 20 mm board to avoid the risk of the fixings penetrating the interior of the building.



Fixing Decking or Purlins

On thin decks, additional roof deck can be overlaid; or alternatively fix purlins set to the correct centres screwed first at the verges externally.



Fixing Purlins to thin decks

Then using a string line screw through the deck into the purlins from inside the building; securing the purlins onto the roof ready to accept the Onduline sheets.

Insulation and underlay membranes



Insulation upgrade

The thermal performance of your building can be upgraded by laying insulation boards between the purlins, having first laid an Ondutiss membrane.



Onduline underlays

The Ondutiss roofing and vapour permeable roof underlay range is designed for use below Onduline sheets. Select the membrane that matches your project needs.



Laying Ondutiss membranes

Follow the Ondutiss product fixing instructions, this requires 10 cm roll end laps and fixing to the deck with 10 mm large headed clout nails at 150 mm centres.

[Return to Contents](#)

Fixing skills:

Onduline is designed to be simple to both handle and fix requiring a minimum of trade skills and equipment, just take the time to familiarise yourself with these basic skills and use the recommended tools and success is assured.



Fixing Skills - Cutting sheet



Marking out the sheet

Carefully measure the size of the material required and mark out the line to be cut onto the sheet surface.



Cutting with handsaw

Use a coarse bladed handsaw to cut Onduline sheets. Apply spray lubricating oil onto the saw to avoid the saw teeth from binding with bitumen.



Cutting sheet width

Support the sheet cut ends and cut the sheet taking time to clean and lubricate the blade as required.



Cutting using power tool

Support the sheet either side of the line to be cut taking care to allow the safe operation of power rotary circular or skill saw.



Cutting using power tool

Always wear safety equipment and consult the manufacturers instructions for safe operation when using power tools.



Cutting using tinsnips

First mark out the sheet or Onduline accessory. Cut with an oiled pair of tinsnips to form detailed shapes in the onduline material.

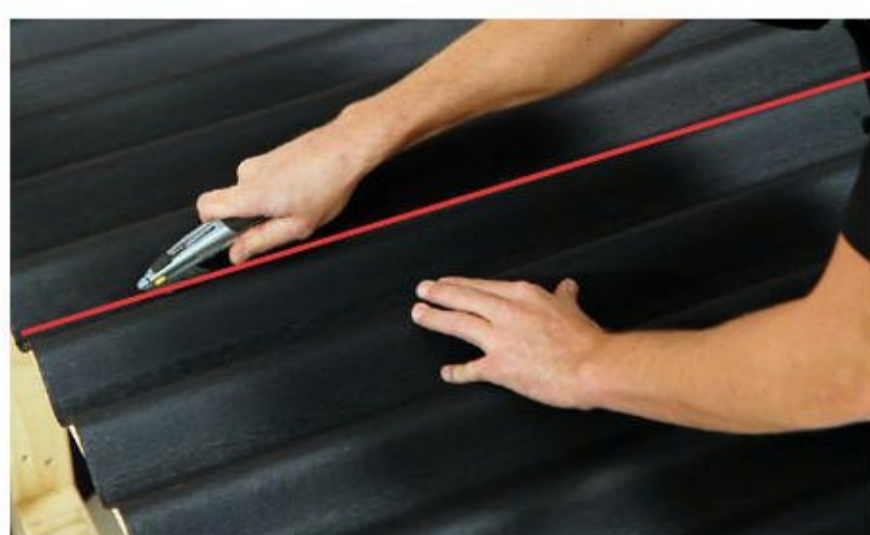

Cutting up corrugation.

First mark out the line of the cut in the base of the sheet corrugation. Use a roofers knife to score the Onduline.

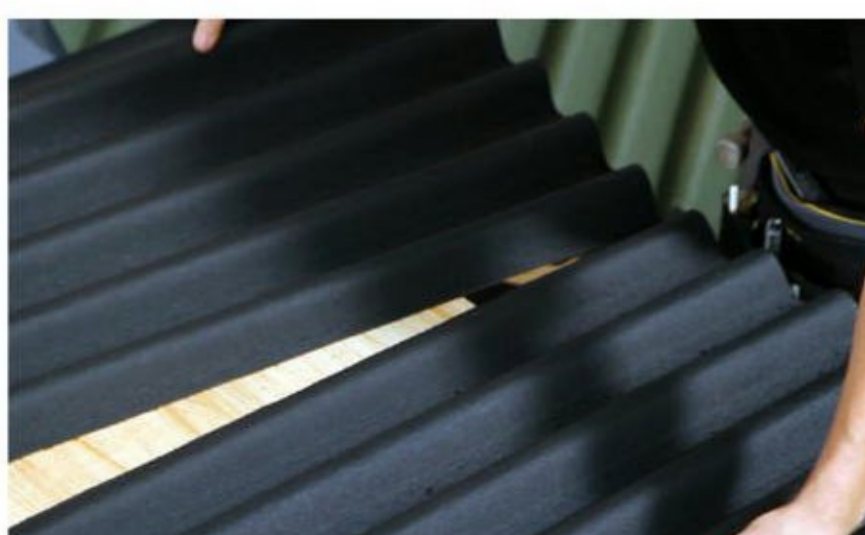

Cutting up corrugation.

Next fold back the sheet along the cut / scored line to separate the cut sections of the sheet.

WARNING

Working on roofs at heights can be hazardous. Always work from a secure ladder or platform and use the appropriate safety equipment. Guidance can be found in Health and Safety Guide HSG33 working on roofs.

[Return to Contents](#)

Onduline fixings:

The Onduline range of fixings allows the sheets to be easily fixed to a wide range of roof structures.

Select the fixing matching your requirements from either Plastic headed nails, or Safetop nail (screw option) or the Onduline universal drill screw.

Plastic headed
Monobloc nails

Safetop nails (+ Screw option)

Universal screws

Onduline sheet fixings

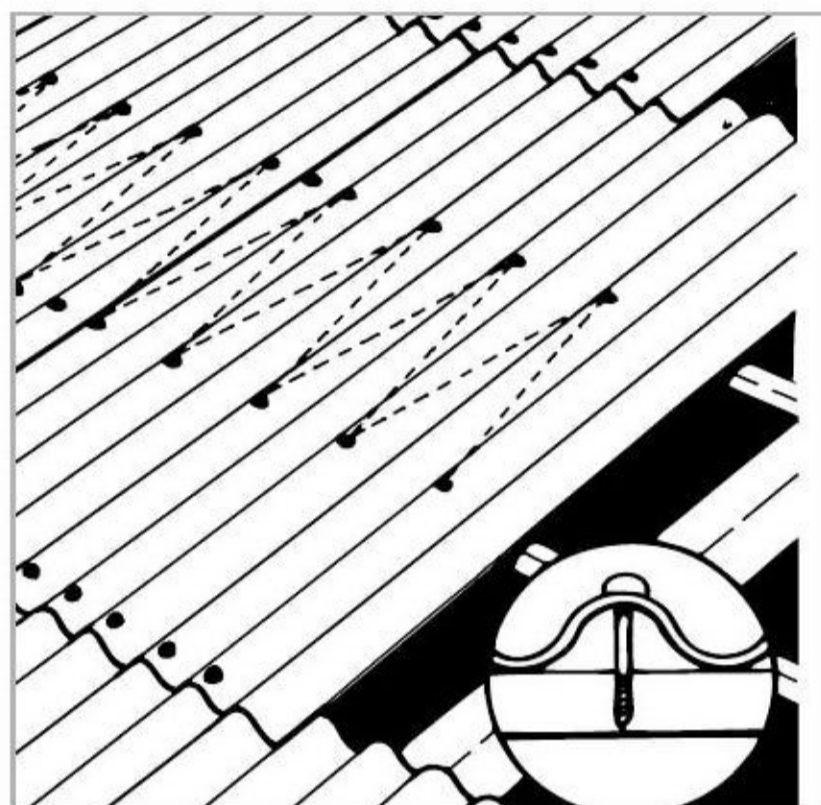

Fixing options Refer to **a:** **b:** or **c:** fixing specifications



Plastics capped Monobloc nails
Onduline plastic headed nails are a cost effective solution for fixing the majority of roof types.

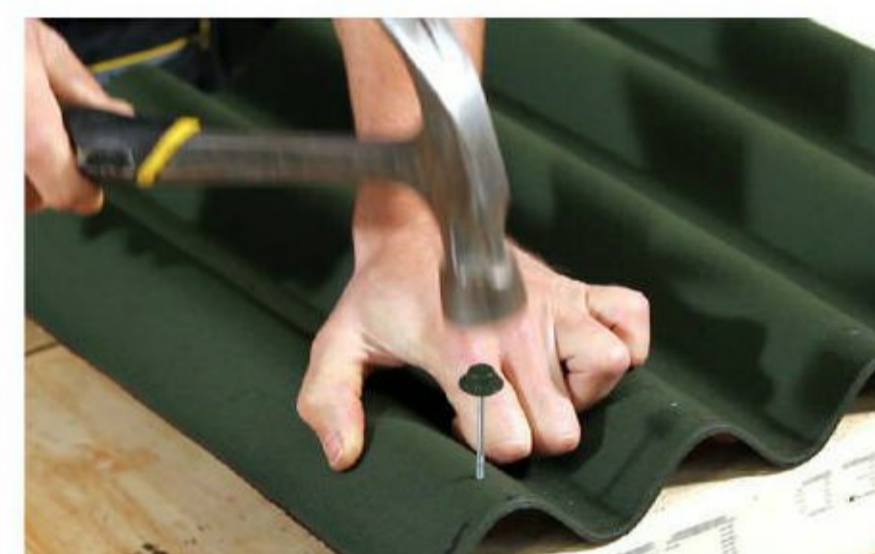

Plastic capped Monobloc nails
Fix by striking the preformed Monobloc head with the hammer through the top of the corrugation. Note: You do not have to pre-drill the sheet.



Safetop nail fixing

The safetop assemble features a heavier duty nail, use by nailing through the washer into the top of the sheet corrugation.



Safetop screw fixing

Alternatively, you can replace the standard nail supplied with a proprietary screw; using the cap and washer, ideal for fixing the sheets to thin decked roofs.



Safetop washer cap.

The safetop assemble is finished by clipping the cap onto the washer assemble. Note: If the cap has been displaced use sealant adhesive to secure.



Universal screws

Onduline universal screws can be used on both timber and steel purlins. They feature a screw and integral weathering washer.



Universal screws.

A chuck drill bit holder is used to retain a Phillips HEX insert bit required to drill the universal screw into the purlins.
Note: Bit size 1/4" 25mm PH No2.



Universal screws.

The screw is suitable for drilling into a wide range of standard steel purlins, we recommend you check its suitability prior to starting work by undertaking test fixings.

[Return to Contents](#)

Fixing Details:

To guarantee a professional roof follow the guidance in this section to create a well-founded and durable roof on your building.

Sheet side and end laps

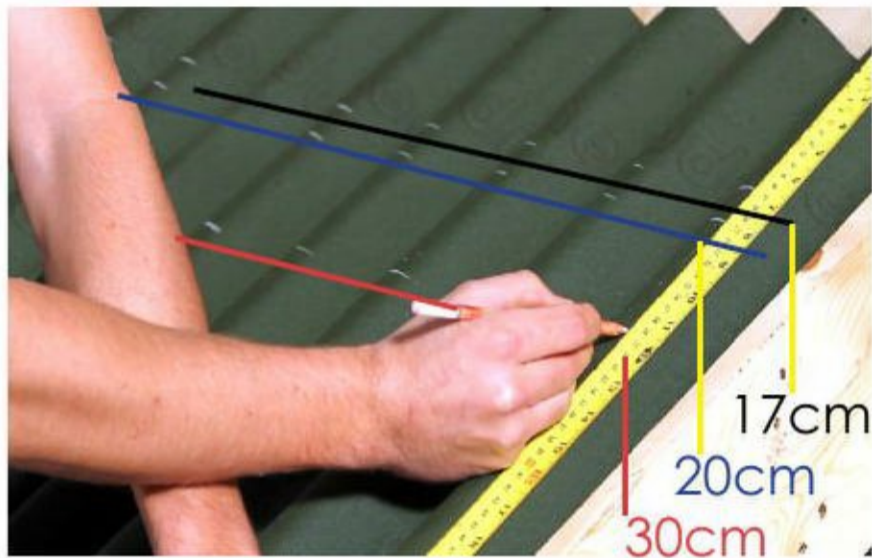

Sheet end lap

Mark out the correct sheet end laps on the sheet matching your roof slope as specified in the a, b, or c roof specifications set out above.

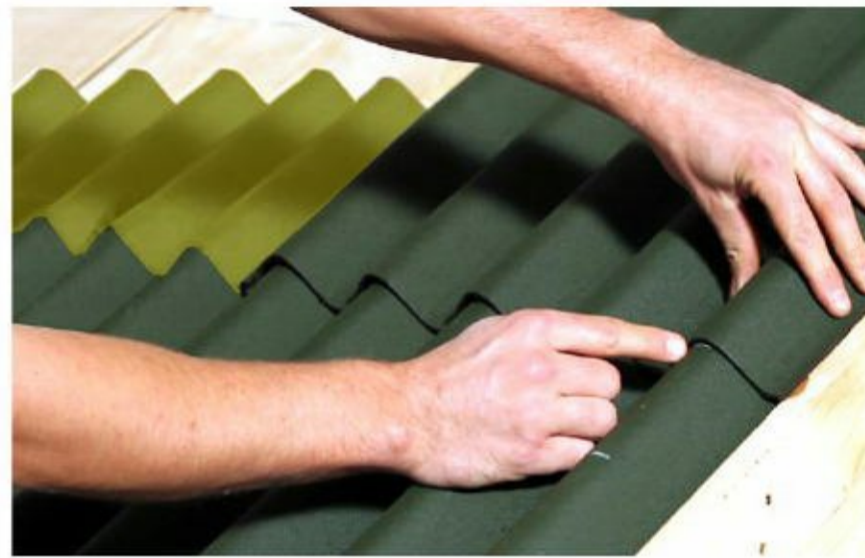

Sheet end lap

The cover width being either:
 a: 15° degrees or greater: 17 cm.
 b: 10° to 15° degrees: 20 cm.
 c: 5° to 10° degree: 30 cm.

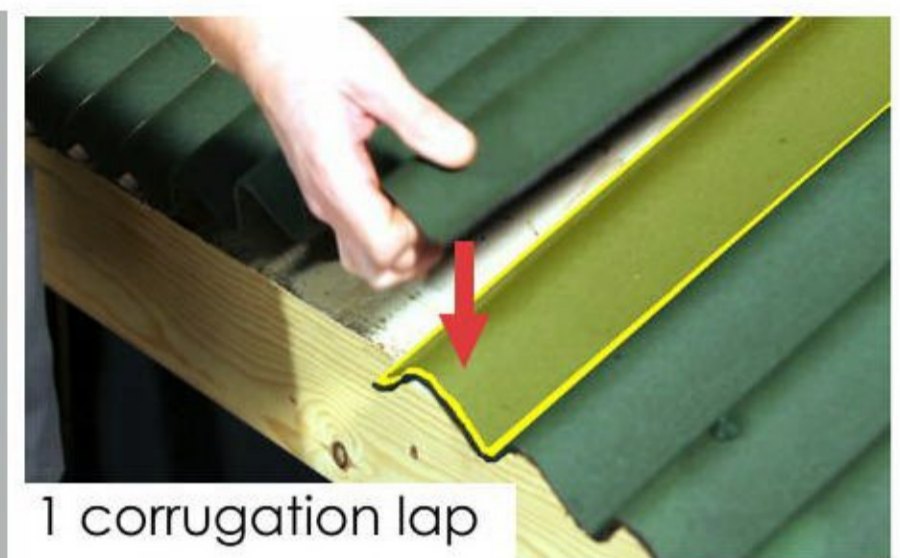

1 corrugation lap

Corrugation side lap

Form a single corrugation side lap on options a and b:
 a: 15° degrees or greater.
 b: 10° to 15° degree.

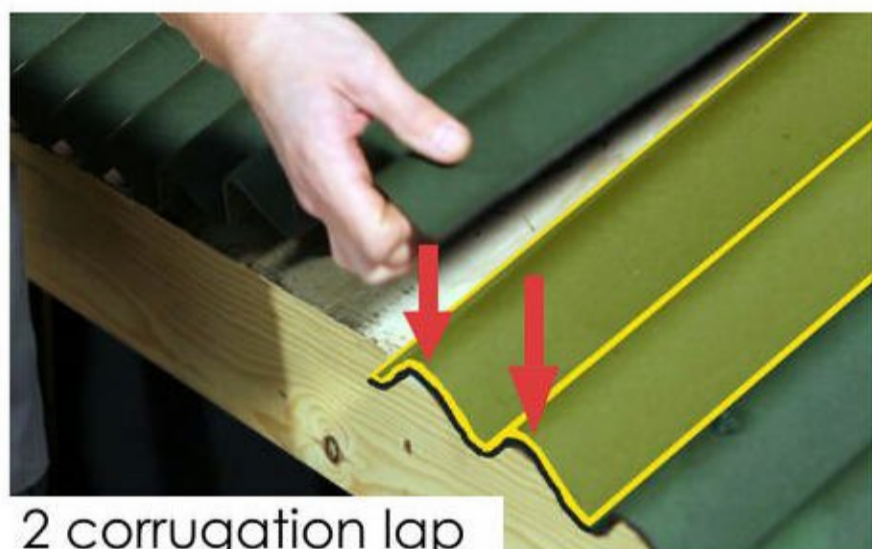

2 corrugation lap

Corrugation side lap

Form a double corrugation side lap for option c:
 c: 5° to 10° degree



Sheet selection

Warning: Always check the sheets are the genuine Onduline Classic sheets. **Beware of imitations!**



Broken bond pattern

When setting a roof out start alternate courses with a half sheet to form a broken bond pattern thus avoiding a 4 ply sheet thickness at edges of sheets.

Eaves fixing details

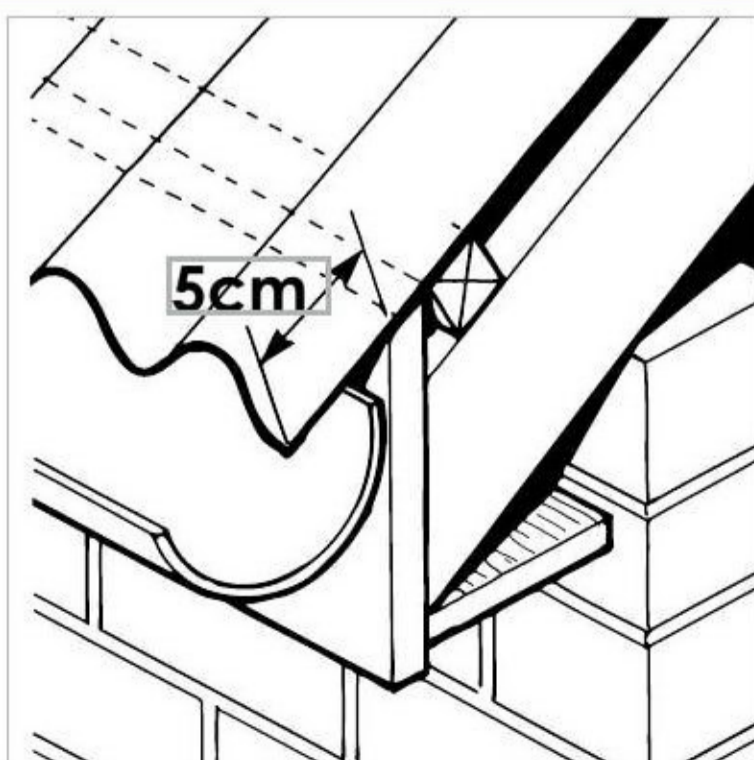

Onduline eaves detail

Allow a nominal 5 cm overhang



Fixing sheet at Eaves

Form a 5 cm sheet drip edge at the eaves. Remember to reduce the distance to the first purlin up from the eaves to allow for the sheet overhang at the eaves.



Eaves and Verge

Ensure the sheets are positioned square to the line of the eaves and verge, first nailing the sheet edges (allowing for laps) to keep sheets square to the eaves line.

[Return to Contents](#)

Eaves fixing options

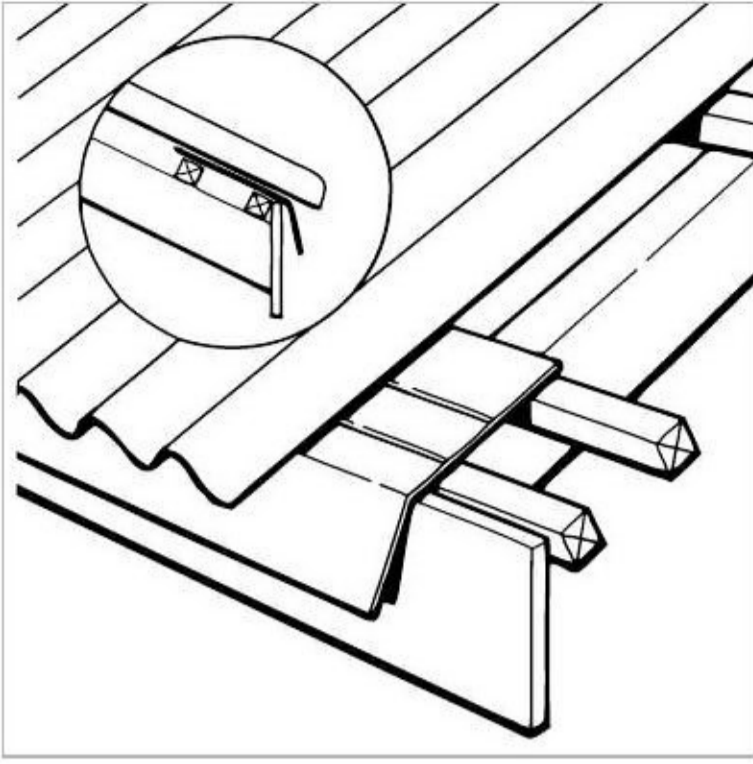

Eaves tray

The versatile Onduline eaves tray can be used to reduce the sheet overhang at the eaves. It is also a component part of the Onduline and Oversheeting systems.

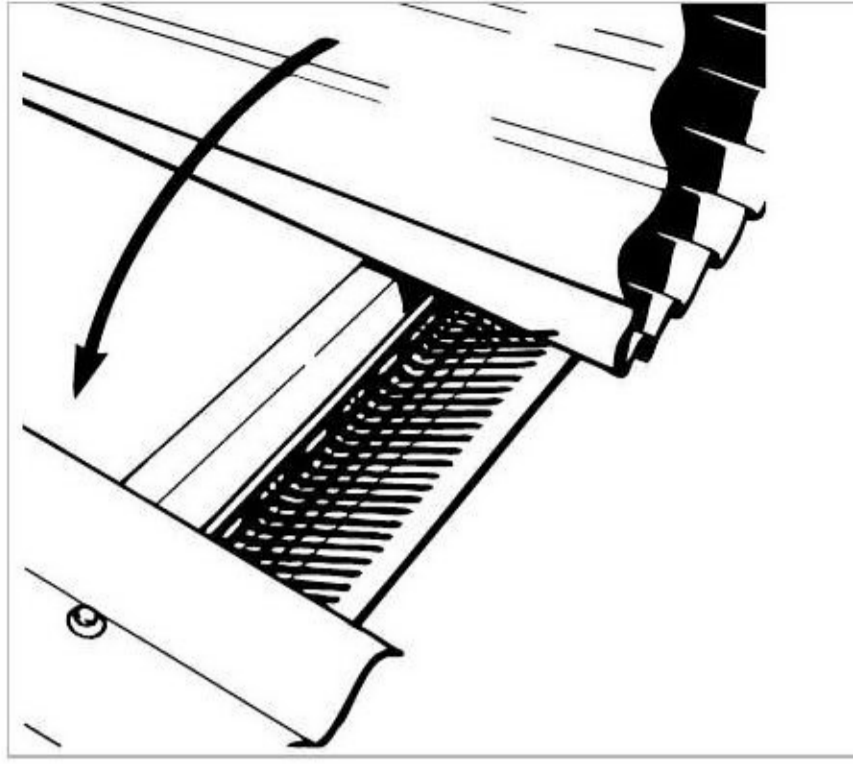

Ventilator comb

Fixed to the eaves and ridge it stops ingress of birds and large insects into the roof space, whilst maintaining a ventilation airflow into the roof space.

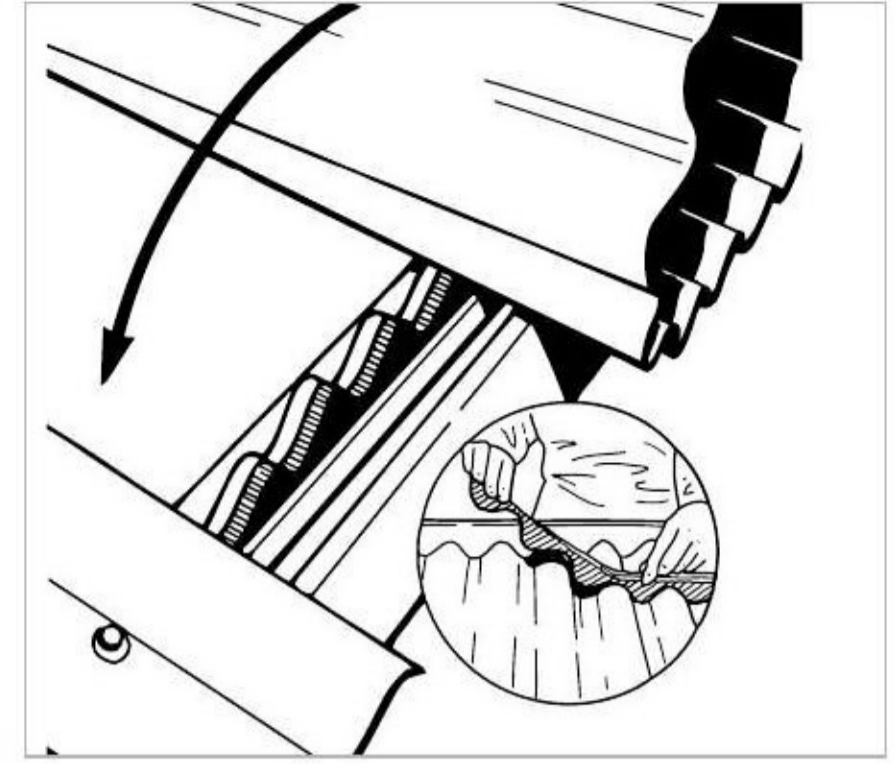

Corrugation filler

Used to seal the corrugations at eaves and ridge from ingress of sand and dust into the roof space. Alternative ventilation provision should be made.

Verge fixing options

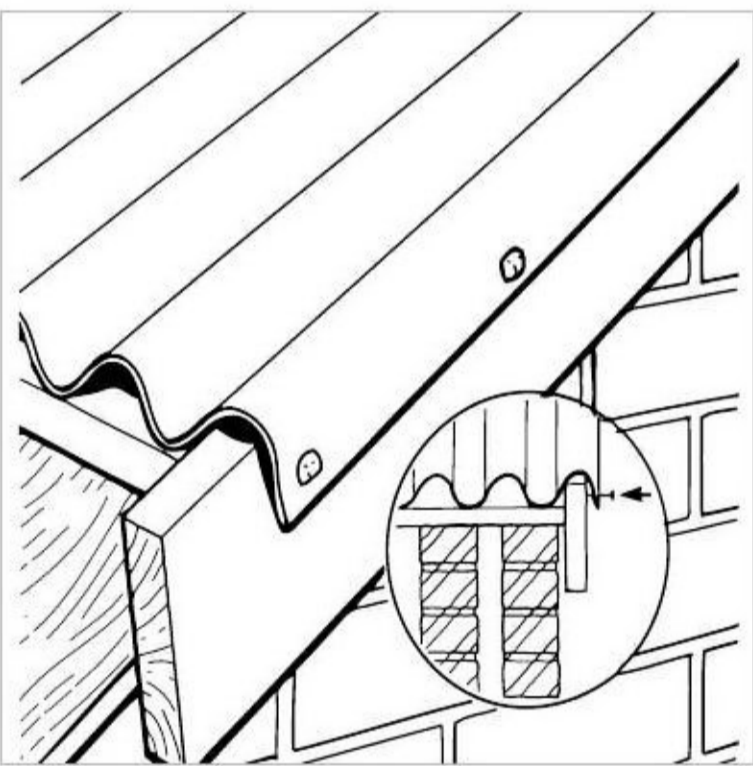

Onduline verge detail

For a superior weathering detail



Nailed verge option

Fix a verge barge board within the last corrugation then fold down the corrugation edge and nail using galvanised clout nails at 15cm centres.



Lapped verge option

First align and fix the verge barge board with the purlins, then overlap the sheet corrugation by nominally 5mm secure by nailing the sheet at every purlin.

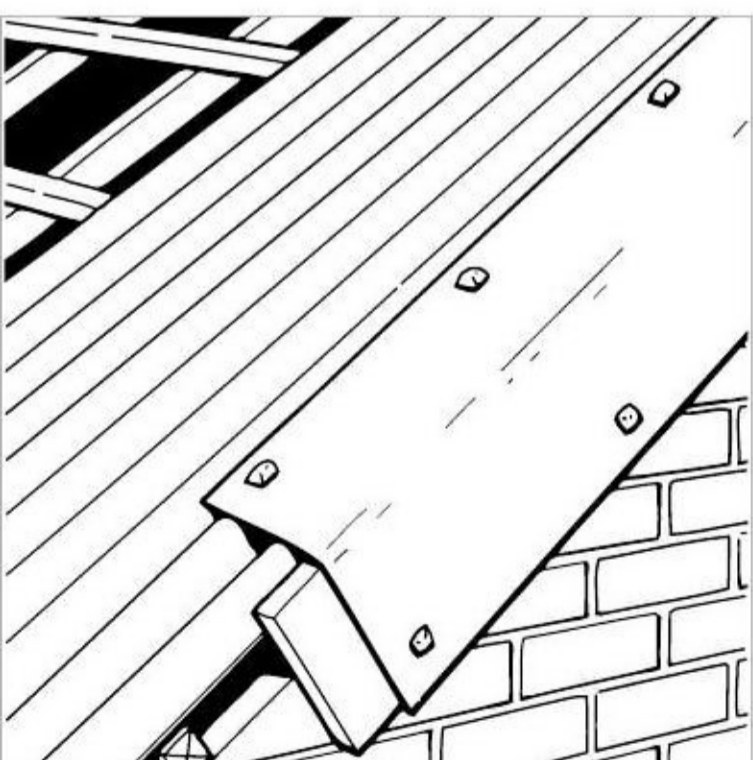

Onduline verge pieces

For a superior weathering detail



Verge piece fixing

First align and fix the verge barge board with the purlins, Then position preformed Onduline verge units with a 20cm end lap (ensure the end lap is secured).



Verge piece fixing

Secure the verge units by nailing through the verge and top of the Onduline sheet corrugation on the roof and through the vertical upstands into the barge board.

Ridge duo pitched roof detail

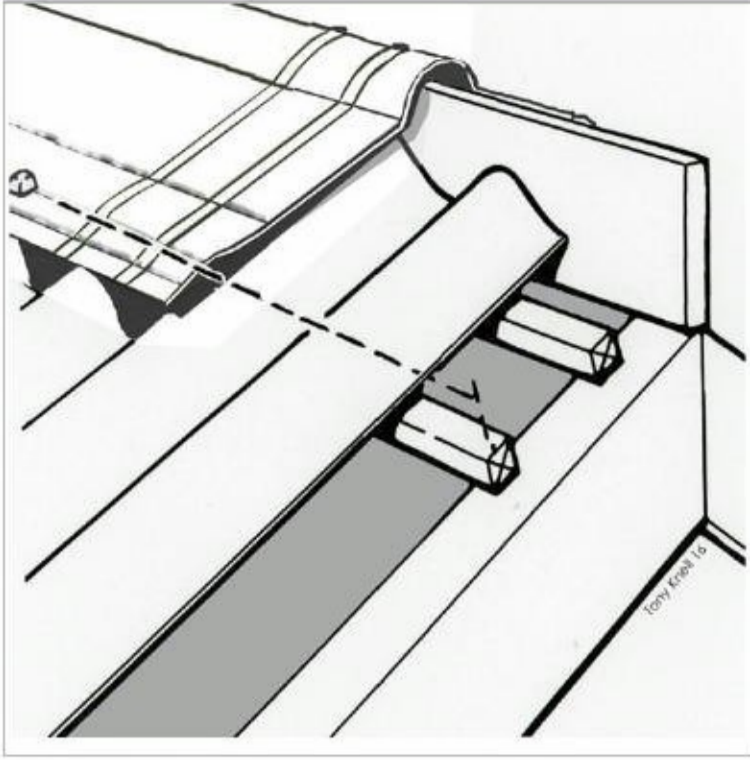

Ridge detail

Providing assured weathering and ventilation into the roof.



Ridge purlin positioning

Use a ridge piece to determine and mark the position of the purlin required to accept the ridge fixings. Its position is variable dependant on the roof slope.



Ridge purlin fixing

Screw or nail the purlin into place onto the roof trusses. We recommend that purlins are also positioned to support the sheet ends at the ridge.



Ridge piece fixing

Lay the Onduline preformed ridge units into position they are sufficiently flexible to allow the ridge to be formed to match variable roof slope.



Lapping ridge piece

Ridges are fixed by aligning the preformed grooves (nominal end lap of 220mm), the ridges are laid from the opposite end of the roof from the prevailing wind.



Fixing ridge piece

Mark a fixing line on the roof and secure the ridges by nailing every other corrugation ensuring the grooved ridge piece laps are secured either side of the lap.

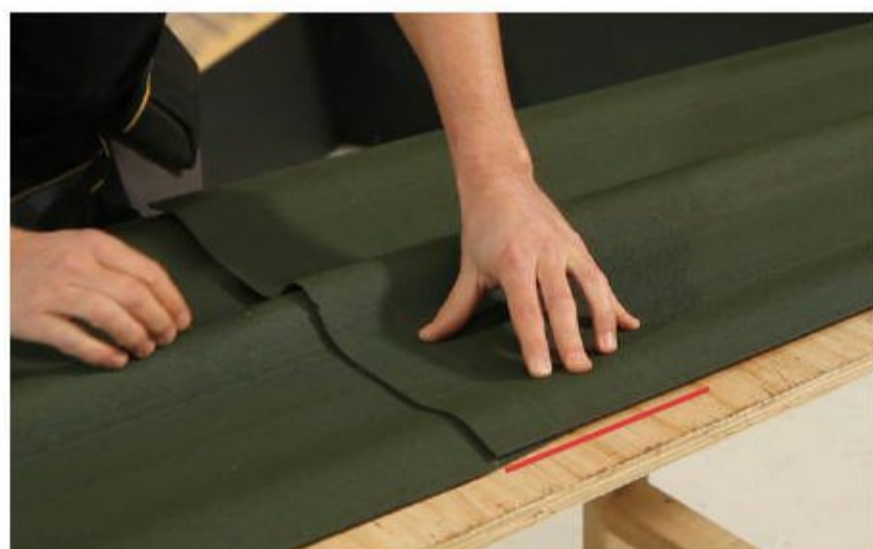

Option. Trimmed laps

A superior ridge line finish can be achieved by trimming the lower ridge piece to be lapped, this provides a smoother line to the ridge pieces once fixed.



Option. Trimmed laps

To do this use a roofers knife to trim the edges of the end of the ridge piece to be overlaid.



Option. Trimmed laps

Trim the ridge pieces on a bench then install on the roof. Always use a deep straight to cut against as a safeguard against the knife slipping.



Option. Trimmed laps

Using the trimmed edge option when fixed in position the ridge end laps are less evident and a neater ridge line is established.



Finial ridge closure

Terminate the ridge end by marking out and cutting a treated timber finial to match the ridge profile.



Fixing Ridge finial closure

The finial is then simple fixed to the verge barge boards and finished to match the decorative finish applied to the verge barge boards.

[Return to Contents](#)

Mono pitched ridge using verge or ridge pieces

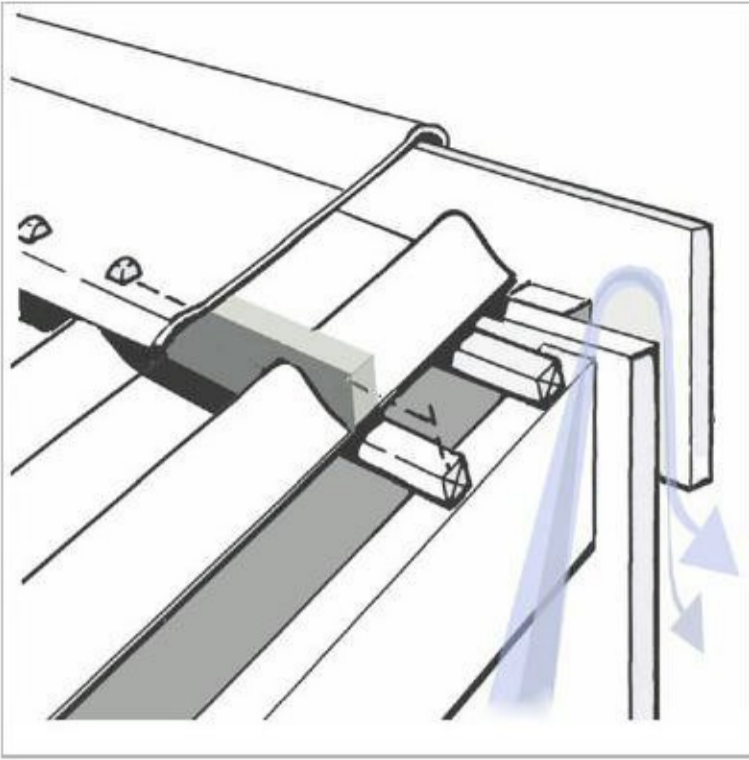

Mono ridge verge detail

Using Onduline verge pieces and corrugation filler.



Mono ridge structure

Mark out and fix a ridge fascia board, incorporating a high level ventilation channel into the roof space providing a continuous 10mm air gap into the building.



Onduline eaves filler

Position and lay Onduline corrugation filler onto the Onduline sheets to seal the corrugations from wind driven rain and snow at the eaves.



Fixing verge pieces.

Next lay the verge pieces over the mono ridge abutment, compressing the corrugation filler by fixing into each corrugation.



Completing the fixing

Complete the fixing by nailing rear of the verge trim onto the ridge fascia board at 15cm centres. Press the safetop caps onto the washer bases.



Overlay Verge abutment

At verge and hip abutments the ridge section must always be laid onto the verge / hip section to weather the roof.

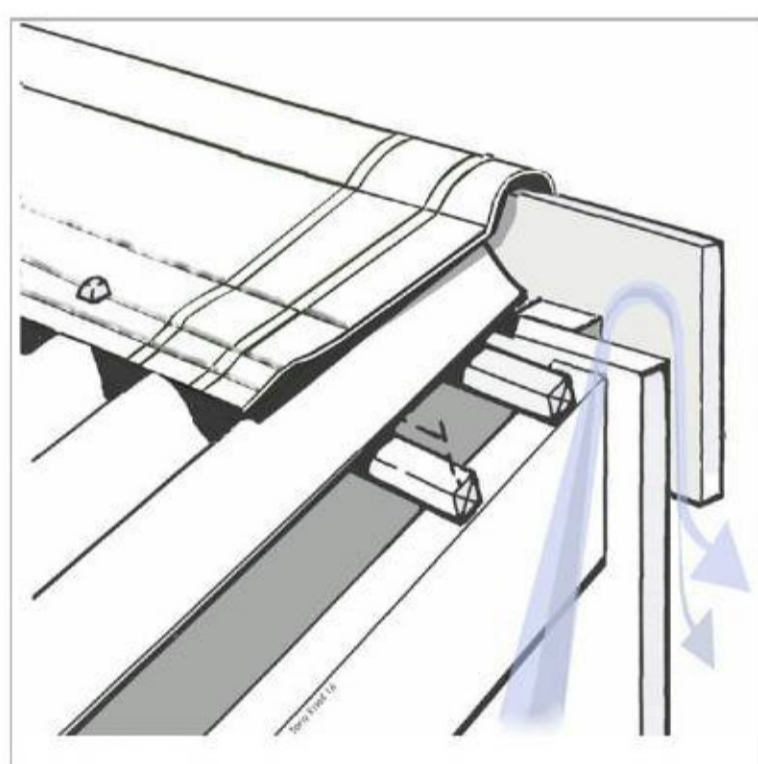

Mono pitch ridge detail

Using Onduline ridge pieces to weather ridge detail.



Onduline ridge piece

Alternatively Onduline ridge pieces can be used to seal a mono ridge abutment after first fixing an additional purlin to accept the ridge fixings.



Onduline ridge ventilation

The corrugations provide a high level ventilation into the roof space. The ridge is nailed to every other corrugation and either side of the ridge end laps.

Wall cladding & rain-screen applications

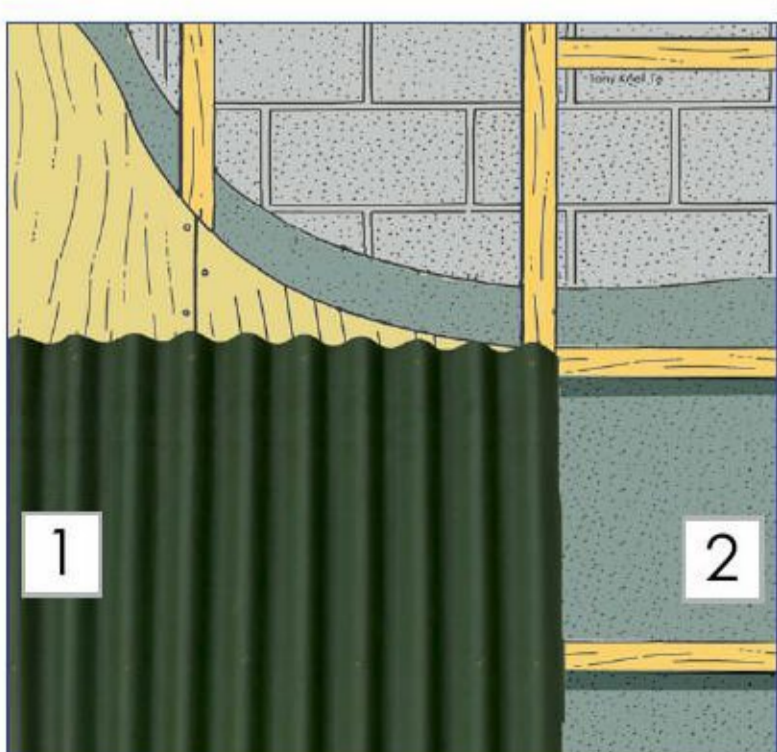

Wall cladding fixing specification

The sheets can either be laid on a studded Plywood frame (1) with a vapour permeable membrane laid to the wall prior to fixing the treated timber studding with high and low ventilation provided to the sheet. Alternatively the sheets can be laid on a timber studded frame (2) with the purlins set at 61 cm centres. However, if insulated boards are placed between the purlins the spacing can be opened to 90cm. Onduline sheets should not be laid within 1 metre of ground level.

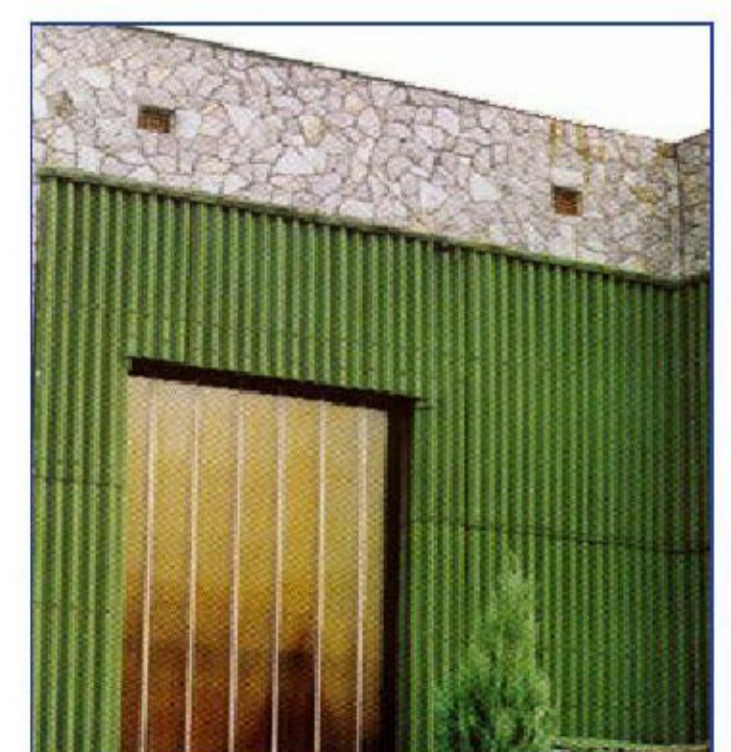

[Return to Contents](#)

Valley detail

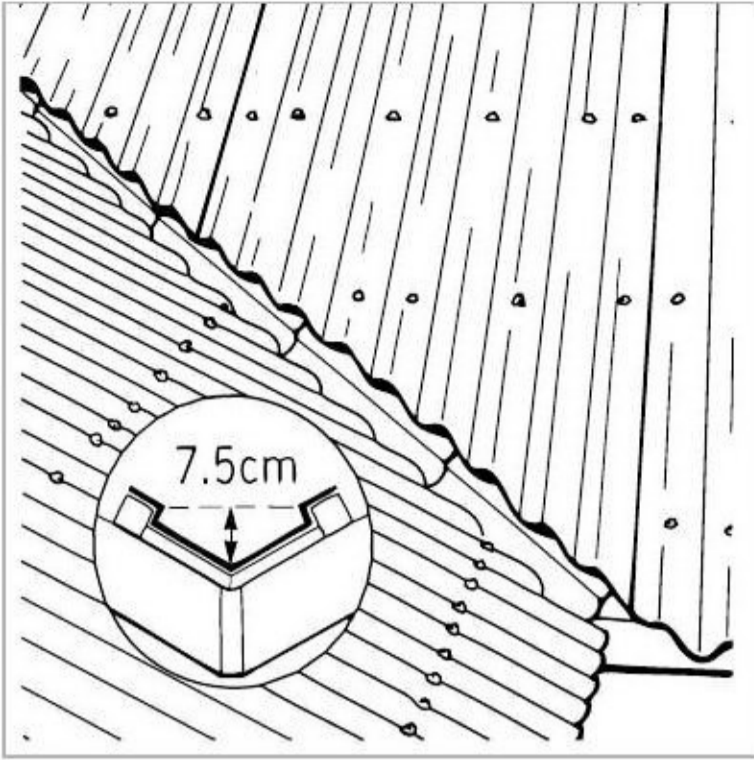

Onduline valley detail
Minimum 7.5 cm valley drainage



Valley support structure
The support structure to the valley is constructed by first fixing trimming battens to the purlins, and lining with valley boards to provide a 7.5cm gutter depth.

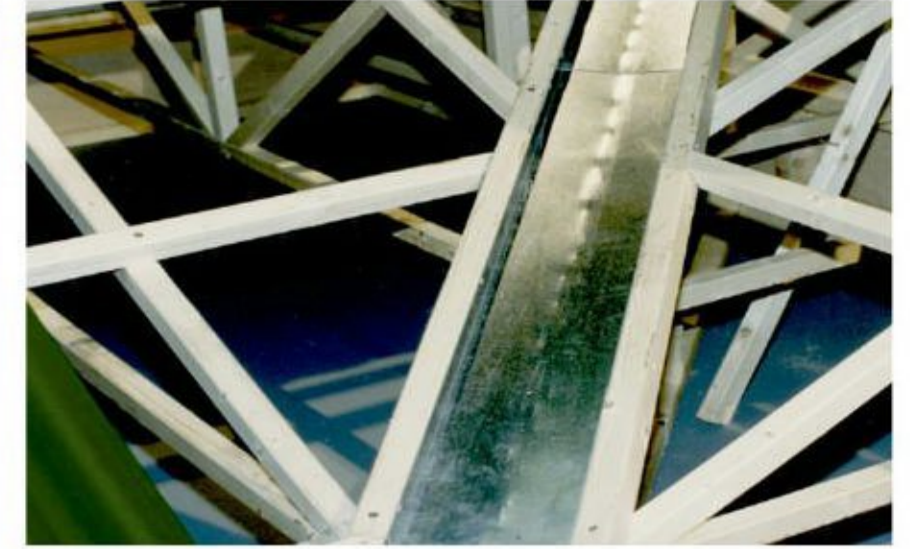

Valley lining options
The valley base can then be overlaid with metal or suitable roofing membrane weathering membrane to form a durable valley lining.



Fixing GRP valley lining
Alternatively pre-formed GRP valley liners are laid between the purlin trimming battens and secured by nailing. Underlay can be dressed over the upstands.



Onduline valley lining
Another option is to use pre-formed Onduline valley lining pieces, these laid on fully supporting plywood valley boards positioned.



Fixing valley lining
The Onduline units are secured to the purlin trimming battens by nailings at 20cm centres up the line of the gutter.



Marking sheet to valley
Position the Onduline sheets up the line of the valley and mark out the cut line, allowing for a minimum of 4cm sheet drip edge into the valley gutter.



Cutting sheet
Remove the sheets from the roof supporting either side of the required cut line, then use a mechanical saw to cut the sheets as required.



Positioning sheet
The sheets are then positioned back on the roof, aligned square to the line of the roof sheets providing the minimum of 4cm drip edge into gutter.



Fixing sheet to valley
The sheets are fixed in place allowing for the correct sheet side and end laps. The fixings are secured up the line of the purlin trimming battens.



Fixing sheet to valley
The fixings to the roof sheets can then be applied.

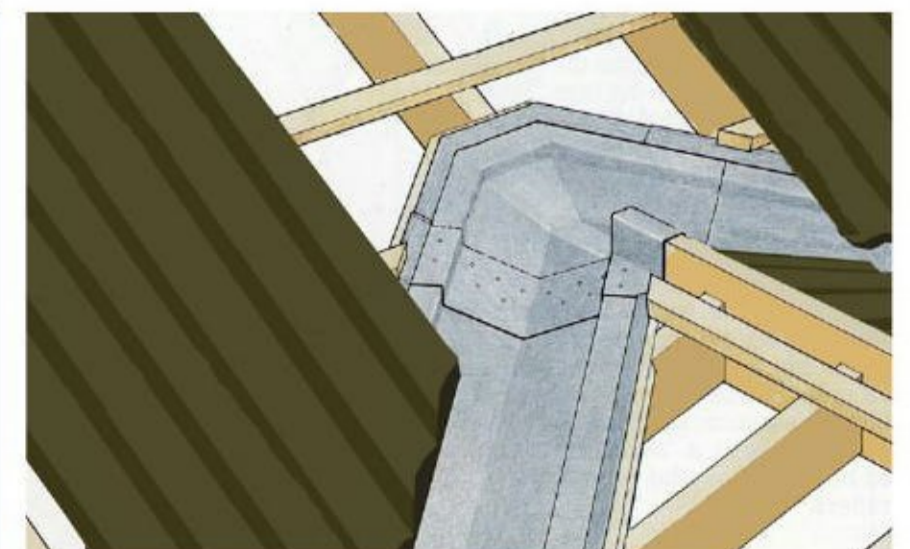

Valley saddle detail.
a saddle weathering should be used to seal the valley lining at the ridge abutment, allowing the ridge pieces to be laid onto the roof.

[Return to Contents](#)

Hip detail

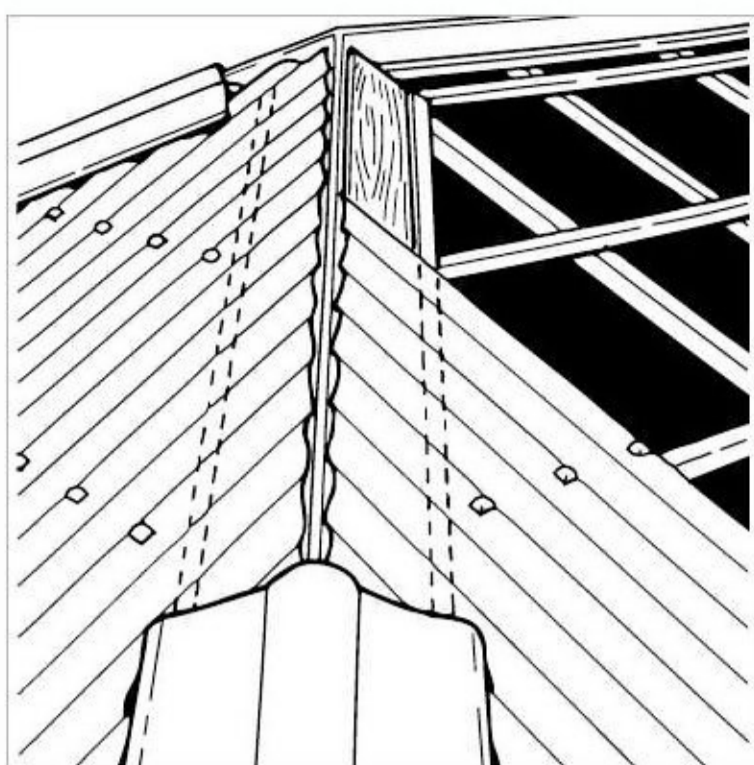

Hip detail

Assured weathering detail



Hip support structure

Position the Onduline sheets up the line of the hip and mark the line to be cut allowing a 5cm sheet drip edge at the eaves. Remove from the roof and cut.



Fixing the sheets to hip

Reposition sheets back onto the roof, square to the line of the roof provide the correct side and end laps. A hip board will assist in this and also support the ridge units.



Aligning ridge pieces

Position and carefully mark out a line to which the ridge pieces can be aligned up the hips. Start fixing the ridges from the eaves up the line of the hip to the ridge.



Fixing ridges to hip

The ridges are fixed to the lines marked out on the sheets. Fixing through the ridge top of the sheet corrugation into each purlin up the roof hip.



Fixing ridges pieces

The ridges are fixed by aligning the ridge piece pre-formed grooves (nominal end lap of 220mm), in accordance with the fixing specification.



Hip to ridge joint

The ridges are cut into the line of the ridge board. The ridge units can then be overlaid and fixed to form the hip abutment.



Hip ridge abutment

On exposed sites the lapped section between the hip and ridge pieces should be sealed with Onduline sealant adhesive.



Trim hip ends

The hip ridge pieces can be finished at the eaves by trimming the ends to the line of the eaves using a saw or tinsnips.

Onduline roof window



Onduline roof window

For illumination and ventilation.



Onduline roof window

The front apron laps onto the lower sheet, this might require an extra short purlin to accept the front apron fixings.



Fixing Onduline window

Complete by cutting and lapping the sheets onto the back and side window weathering aprons and then fix to purlins.

[Return to Contents](#)

Onduline roof ventilators

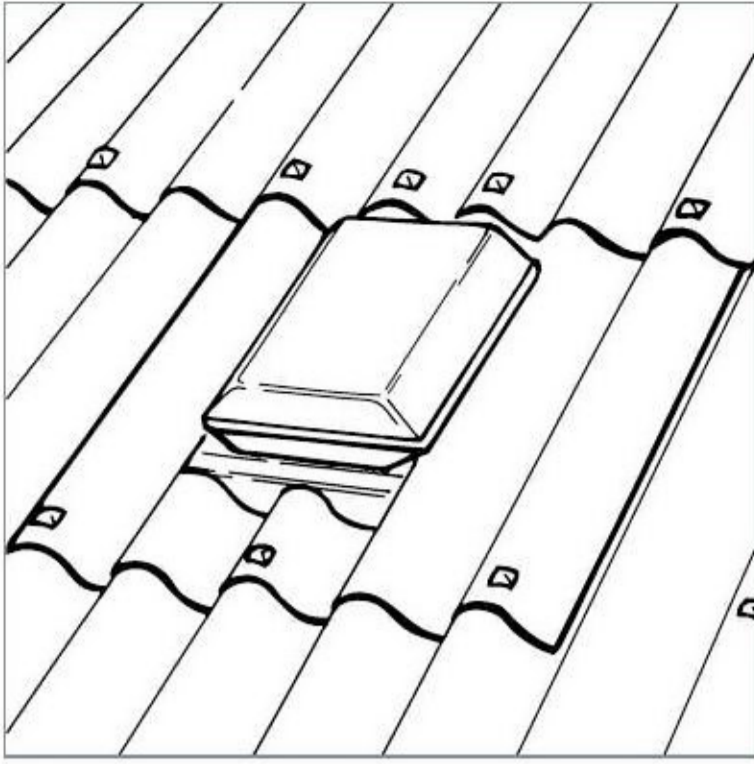

Onduline roof ventilators
For assured roof ventilation.



Basic verge detail
Roof ventilators are available in two sizes to provide increased ventilation and should be used mid span on roof slope / lengths greater than 11m.

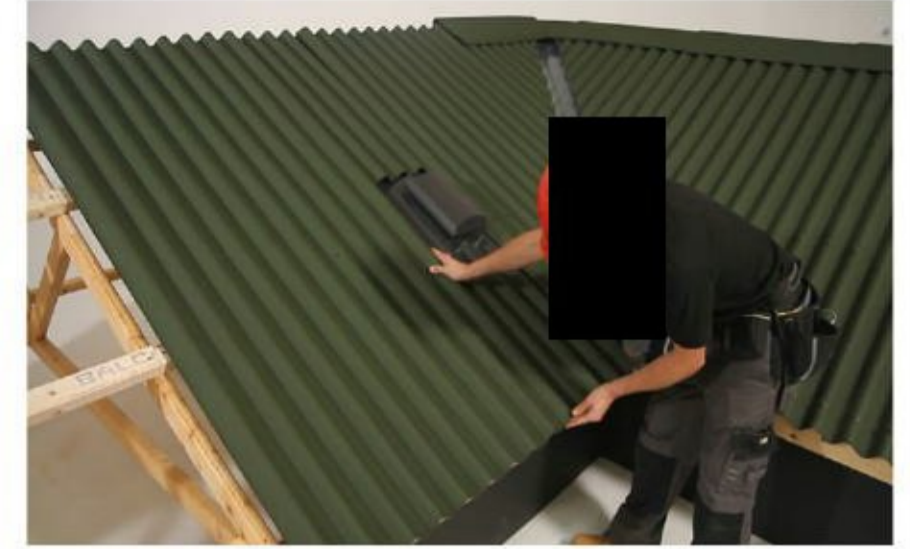

Onduline verge pieces
The ventilators are fixed between the purlins. The apron is lapped over the lower sheet, with the integral side and back gutter aprons being lapped by next.

End wall abutment

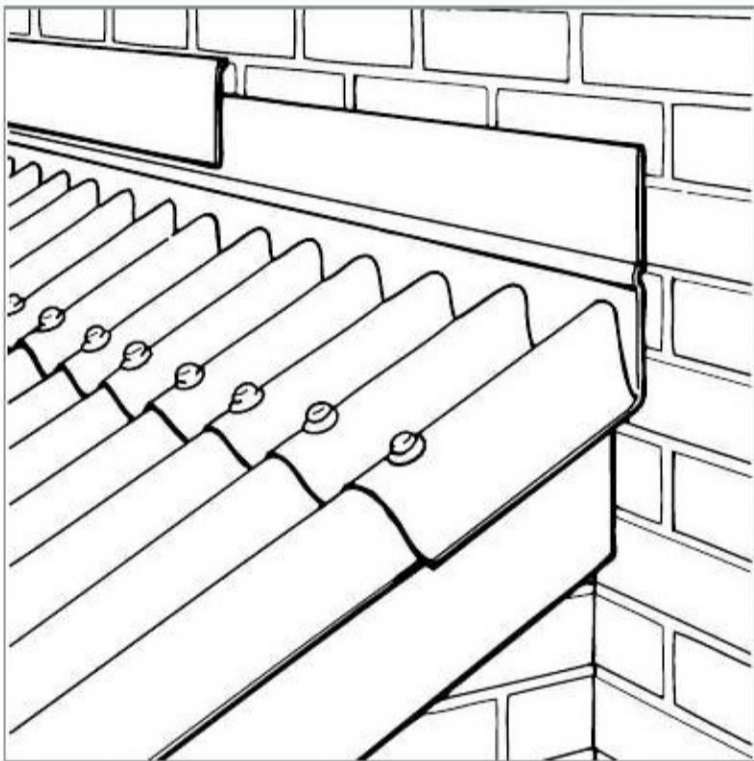

Onduline apron pieces
For a superior weathering detail



Onduline apron fixing
Use Onduline pre-formed apron flashing piece to seal end wall abutments. Lay the upstand against the wall and fix the front apron at each corrugation.



Apron cover flashing
To allow for differential movement between the wall and the roof sections always use a separate wall cover flashing dressed into a prepared joint.

Side wall abutment detail

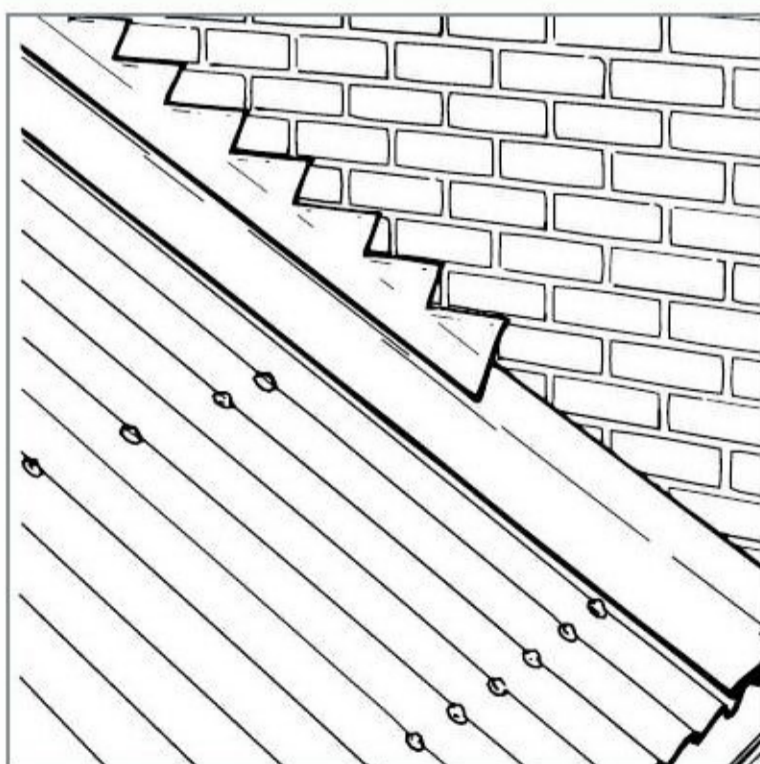

Side wall abutment
Metal or preformed proprietary side wall abutments; or Onduband self-adhesive flashing tape are used to seal side wall abutments providing a minimum of 7.5 cm upturn against the wall and dressed over at least one full Onduline corrugation. Complete with a separate wall cover flashing.

Side wall abutment
Overlay at least one Onduline corrugations with a proprietary preformed abutment flashing dressed up the wall and fix through the top of corrugation.

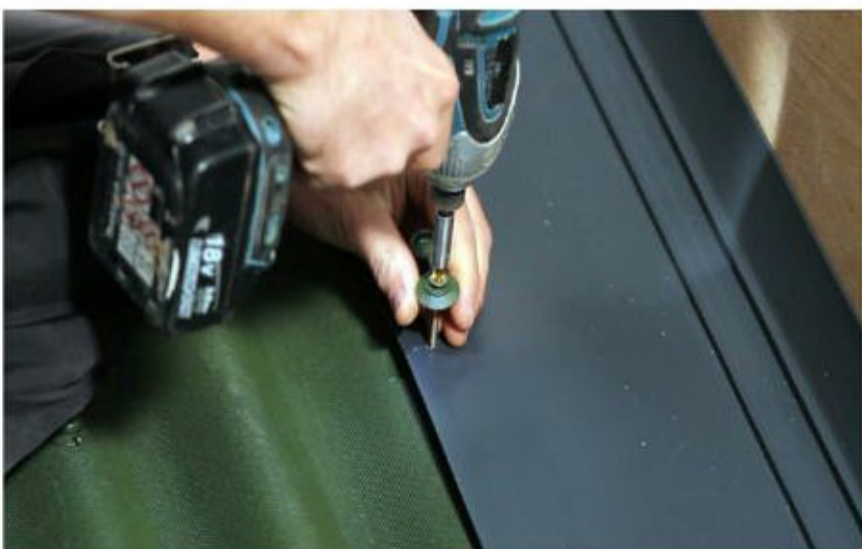

Upstand to wall
To allow for differential movement between the wall and the roof sections always use a separate wall cover flashing dressed into a prepared joint.

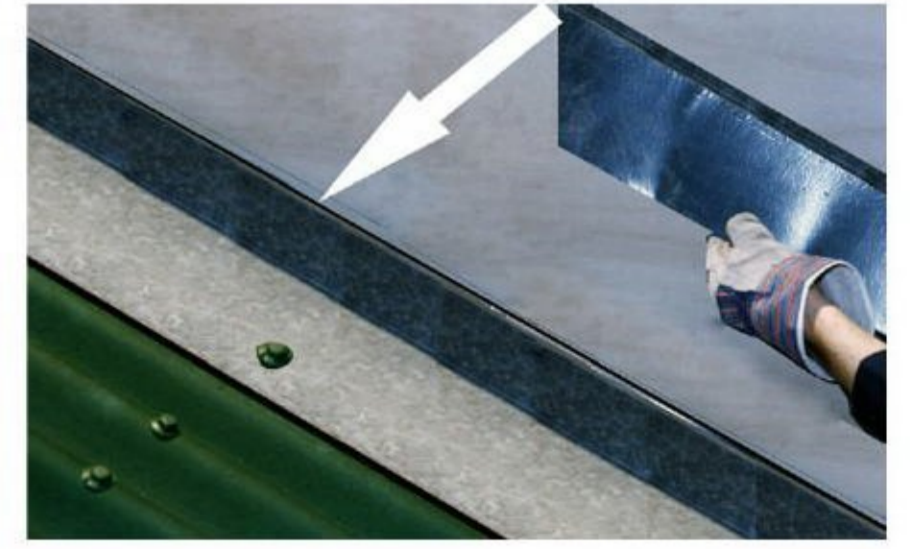

Curved roof detail

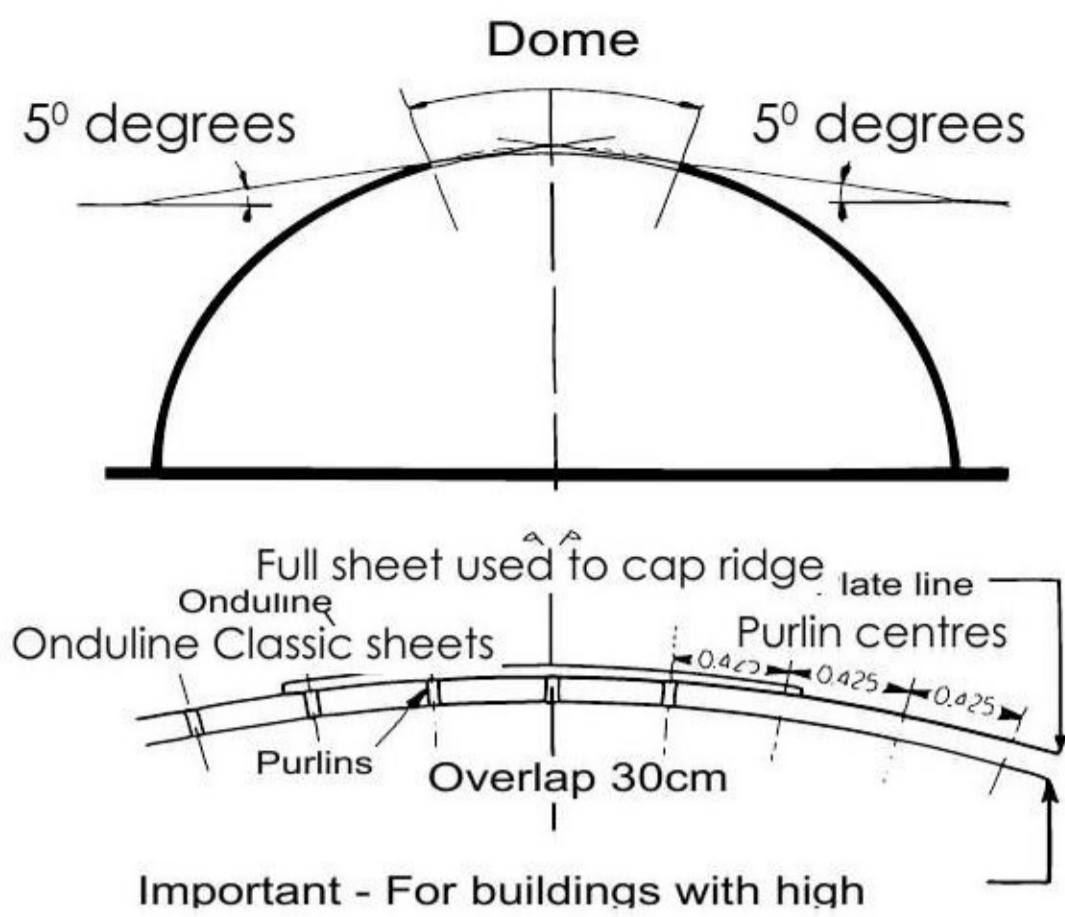

Onduline fixing to curved roof:

Onduline sheets can be formed to curved roofs. First check the sheet can be formed to the required radius. The support purlins at the ridge should be set at 42.5 cm centres as the pitch becomes shallow, the ridge must always be capped with a full Onduline sheet width. The purlin centres on the side cheeks of the roof can be widened to 61 cm. Fix Onduline ventilation units to the roof sides as required.

Note: On buildings with high internal humidity levels close boarding; or roof decking must be used at the ridge and Ondutiss underlay membrane can be used with enhanced ventilation provision.

Fixing sheets on curved roof:

The sheets must always be laid with 2 corrugation side laps and 30 cm sheet end laps on the curved roof.



Sheet laid to roof curve

The sheets are laid with 2 corrugation side laps and 30 cm sheet end laps on the curved roof, position the sheet square to the eaves and verge line.



Marking the sheet

Mark out the sheet nail points on every corrugation along of the eaves, either side of the vertical laps, and every other corrugation on the intermediate purlins.



Fixing sheet at eaves

In this instance we are using Onduline screw fixings securing the eaves line first. Secure the sheet edges first then work to the centre (allowing for laps).



Forming sheet to curve

Use a timber batten to compress the sheet to the required roof curvature then mark out fixing points on the sheet.

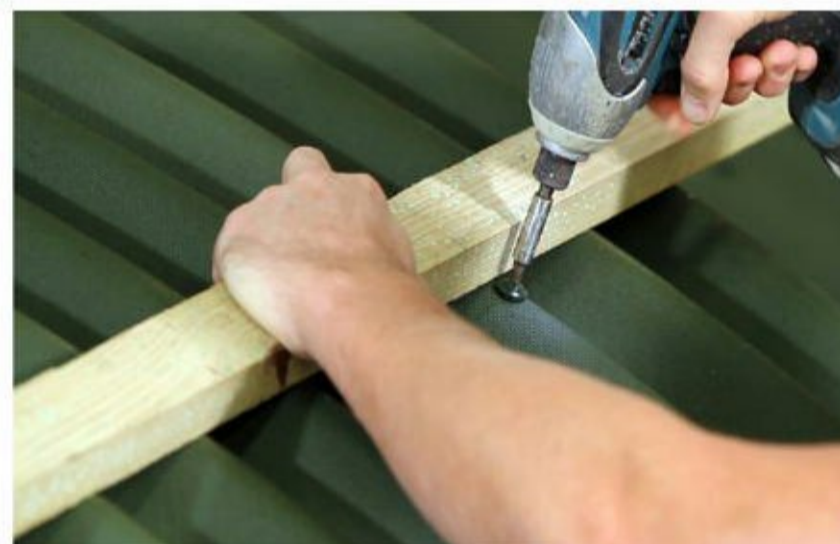

Applying sheet fixings

Maintaining pressure on the batten apply fixings to secure sheet in place, securing the sides of the sheet square to the verge line (allow for sheet laps).



Secure remaining fixings

The remaining fixings can then be secured forming the sheet to roof curve.



Curved roof mono ridge

Onduline ridge and corrugation filler are used to seal mono ridge abutments, fix the sheet at every sheet corrugation and provide high level roof ventilation.

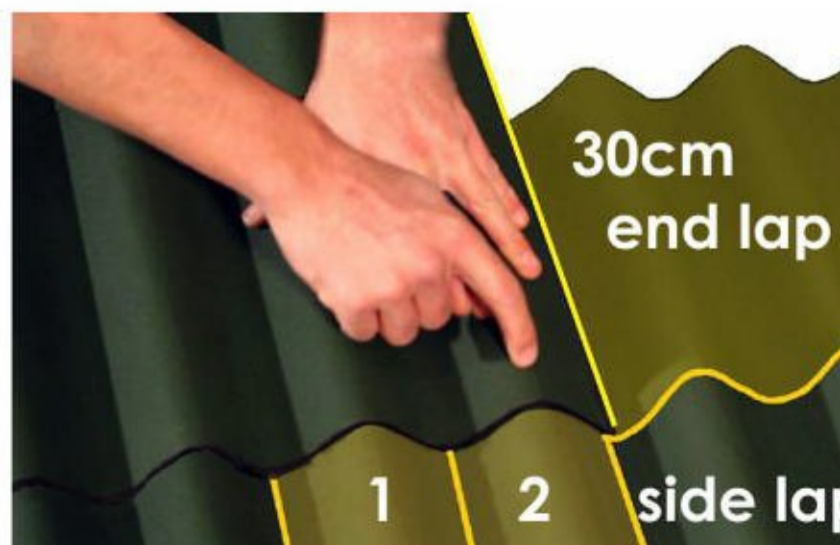

Sheet laps to curved roof

Always provide a double corrugation sheet side lap and 30 cm sheet end lap on curved roof slopes to allow for possible deformation of the sheet laps.



Curved roof specifications

The inherent flexibility of Onduline sheets make them ideal for curved roof projects. Our technical sales department can assist you with your project.

Onduline Plastics:

Onduline Plastic sheets share the same Onduline profile and sheet dimensions and are accordingly simple to fix to your roof, providing top class light transmission provision into your building.

Sheets are available in both crystal clear and opaque finishes and are available in PVC and Polycarbonate materials.

Check out the website for full details on the full Onduline Plastics range.



Fixing plastic roof illumination sheets



Onduline plastics

For a superior weathering and light transmission properties.



Clear; or Opaque sheet?

We offer two roof sheet options; opaque which tends to be easier to handle and clear which is more 'brittle' to handle but offers 'glass' clear light transmission.



Sheet side laps

To avoid sheet discolouration under U.V. heat exposure always lap the Onduline sheet onto the plastic sheets on the sheet side laps.



Drip edge to eaves

Allow for a 5 cm drip edge at the eaves. To protect against U.V. heat exposure discolouration to the plastic sheets, first paint any dark roof support elements white.



Marking fixing points

Mark out the fixing points onto the plastic sheet in accordance with the Onduline sheet fixing instructions.



Pre-drilling fixing points

Pre-drill the fixing holes with a 5.5mm drill to allow for thermal sheet movement around the fixings in service.



Fixings selection

Use the same Onduline fixing matching the Onduline roof section, in this case we are using Onduline universal screws which are generally easier to apply to plastic sheets.



Applying fixings

Carefully screw or nail the fixings into position. **Note:** it is important the fixings are not overtightened to allow for thermal movement in the plastic sheets.

WARNING

Only genuine Onduline Plastics are recognised under the terms of the Onduline product guarantee. The Onduline plastics division will be pleased to assist with the roof illumination PVC, GRP and polycarbonate product range.

[Return to Contents](#)

Design notes:

Please check the website for additional product information, product and design data sheets.



General design notes

Timber Purlin roof design:

Timber purlins should be of sufficient size to provide support the Onduline 95 x 38 mm sheet corrugation spanning characteristics and associated roof loads between supports.

Note:

The table below gives suggested minimum timber purlin sections for roof pitches over 15° including allowances for normal snow loadings.

Span (m)	Typical timber section sizes for treated softwood purlins (on roof pitches above 15°) (mm)
0.450	38 x 25
0.610	50 x 50
2.4	38 x 75
3.0	38 x 100
3.6	38 x 125
4.2	44 x 150
4.5	50 x 150
4.8	50 x 160
5.4	63 x 175
6.0	63 x 200
6.6	75 x 200

Note:

This table is prepared as a guide only in consultation with TRADA the British Timber Research and Development Association. However, design needs can vary according to roof layout and building regulations. Professional advice should always be sought for specific roof design applications.

Snow loadings:

We recommend on buildings situated in exposed locations or situated in elevated regions subject to periodic high snow loading that Onduline sheets are fixed onto a roof deck. And the use of both enhanced vapour control measures and ventilation provision is incorporated.

Maintenance:

To ensure a long life the roof should be cleared of leaves and debris and gutters cleaned regularly. Any branches in contact with the roof surface should be removed.

Fire classification limitations:

Onduline sheets are not classified to External S.AA fire rating as required in UK Building Regulations for some classes of structure. In these instances they must be fixed on a fully supporting roof deck and the sheets coated with a proprietary 'AA' surface paint treatment applied in strict accordance with the paint manufacturer's instructions.

Condensation:

Onduline is highly resistant to the build-up of condensation. However, any single thickness roofing material is at risk of condensation formation. It can also be the case that during the winter month's water vapour present within the building can freeze to the underside of the sheets; this ice then melts as the roof warms in the morning forming water droplets which can drip off the sheets.

Note: Consult the Condensation & Ventilation Data sheet for further information.

Ventilation:

A range of Onduline ventilation accessories are available to assist in the provision of high and low level ventilation which will reduce the risk of condensation formation.



Onduline roof renovation system

The light weight of the Onduline roofing system makes it ideal for Oversheeting existing failing and deteriorated fibre cement or steel pitched roof coverings. The system can be used in either cold or warm roof configurations. For detailed design specifications consult the Onduline roof renovation Oversheeting fixing guide.

Cold roof over sheeting

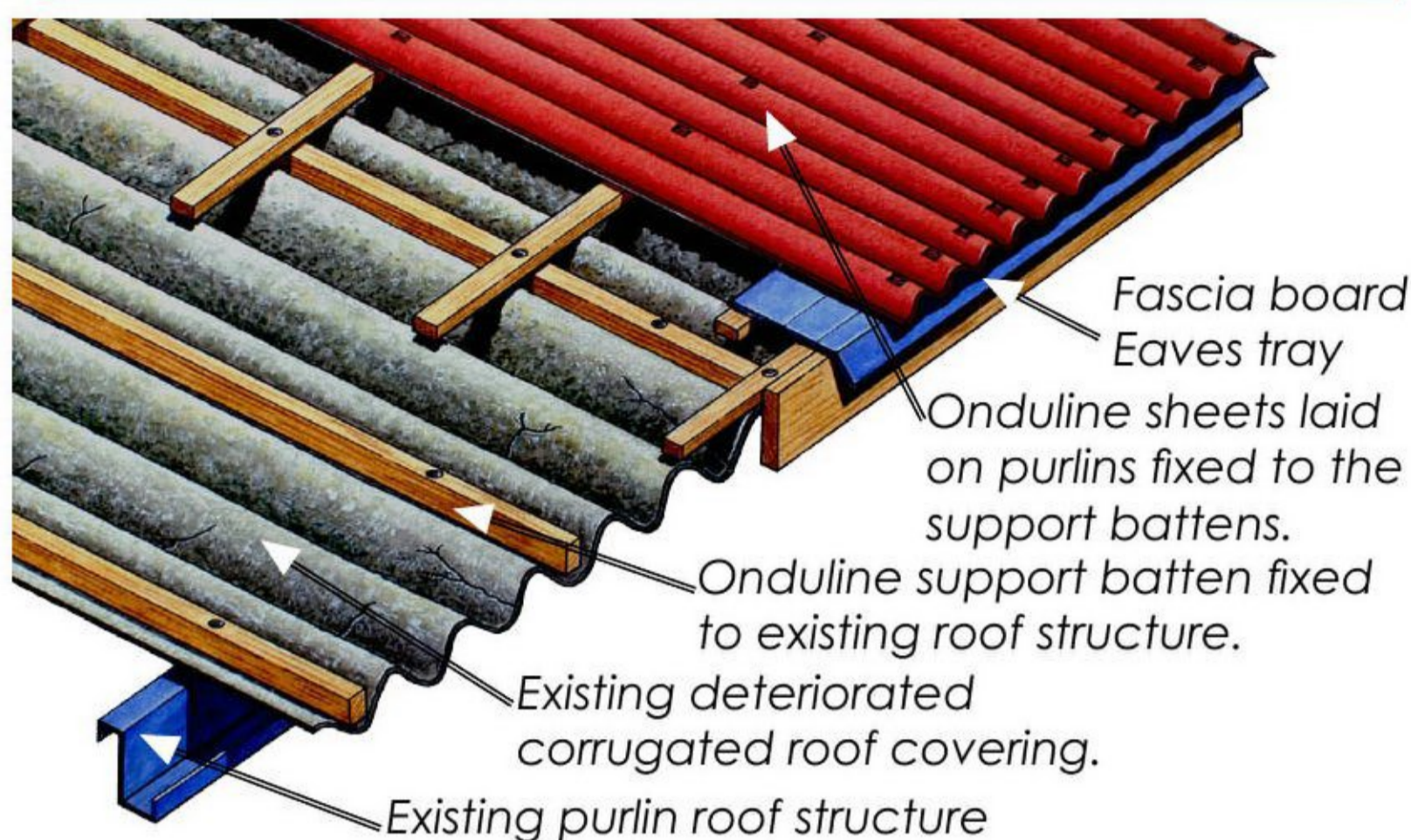

Cold roof over sheeting specification

Determine the fixings required to secure the support battens to the existing roof support structure as required in conformity to British Standards & Codes of Practice. Note: The fixings must offer sufficient resistance to wind uplift specialist fixings suppliers should be consulted for advice. The support battens are then overlaid with the appropriate support structure to the Onduline sheets in accordance with the **Onduline roof renovation fixing guide leaflet**.

Roof preparation:

A thorough inspection of the existing roof structure should be undertaken and any deterioration should be rectified, the structure checked as to its suitability for Oversheeting procedures. A review of the original roof design should also be made to check that sufficient ventilation and insulation is provided and if any necessary alterations are required in the roof refurbishment to upgrade the roof design and performance.



Onduline support battens are fixed to existing roof structure

Support purlins are then fixed to roof structure

Note: The Onduline roof renovation leaflet should be consulted for detailed fixing specifications, technical advice should be sought to detail your specific project.

Warm roof over sheeting

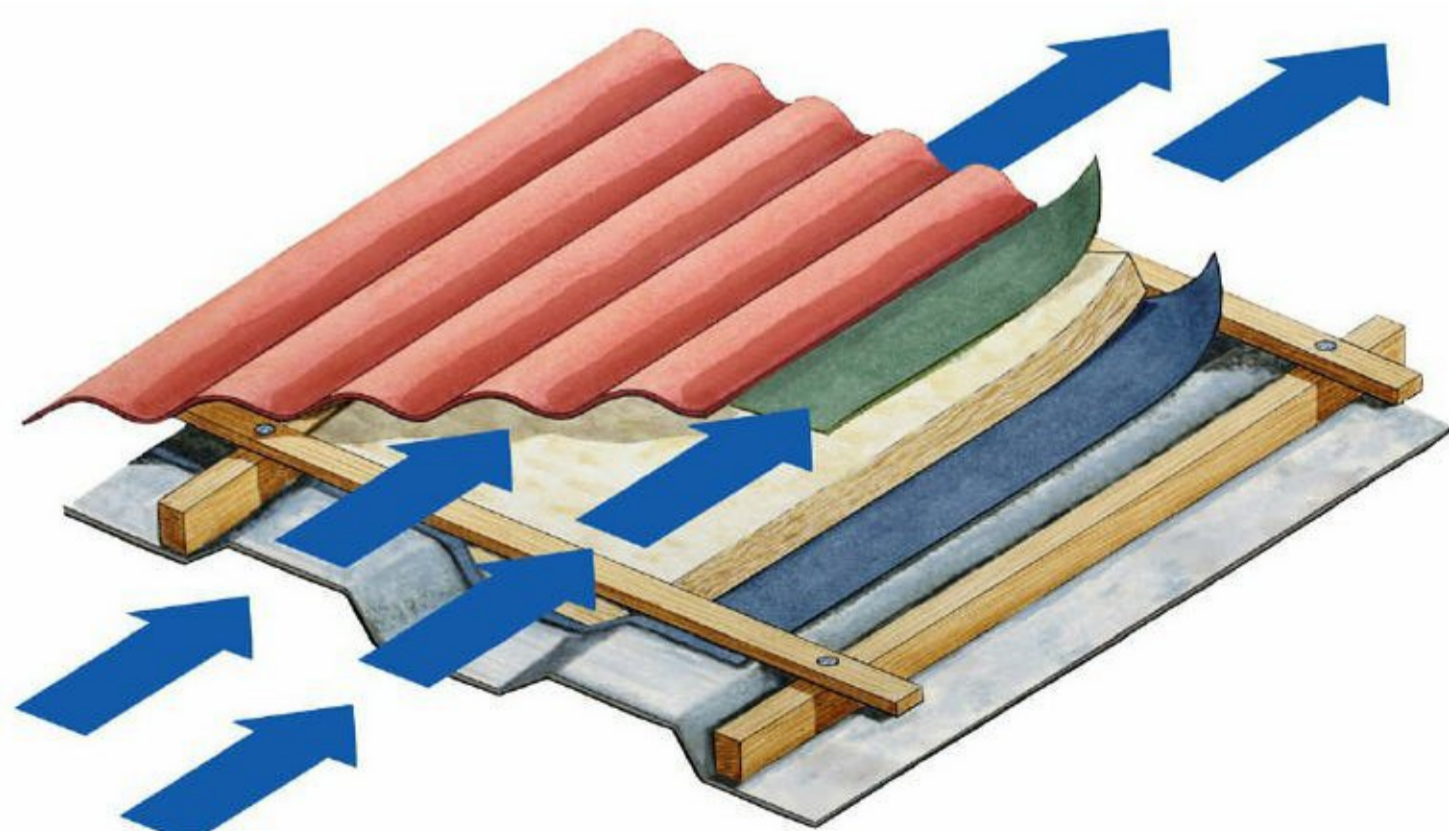

Warm roof over sheeting specification

Insulation is recommended and should always be used on steel roofs to avoid the risk of heat transfer into the building. To reduce the risk of condensation, it is essential that insulation products are laid in accordance with the manufacturer's instructions. They should include an effective water vapour barrier laid beneath the insulation. If high levels of moisture is present within the building, mechanical vapour extraction should also be provided.

The Ondutile system

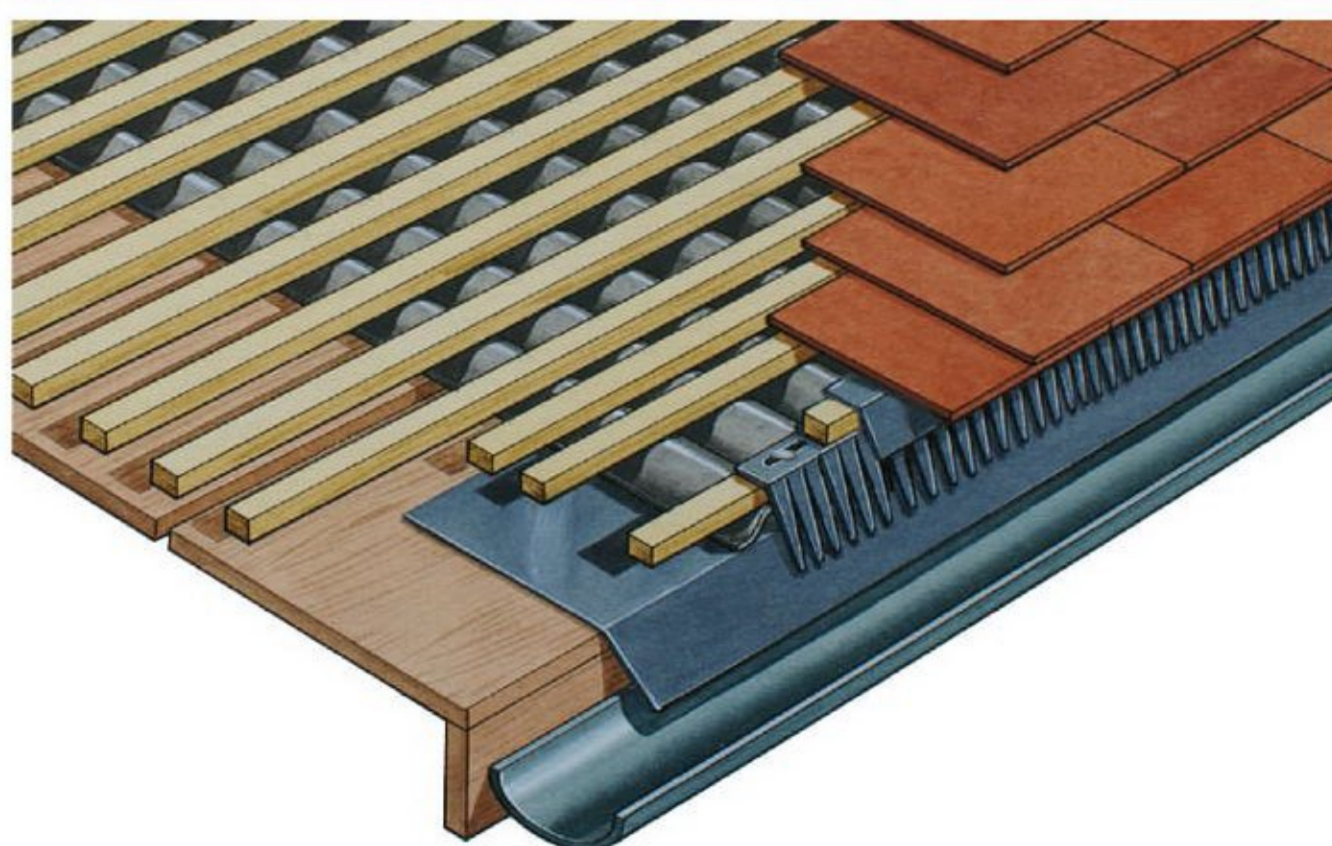

The Ondutile under tile roofing system

Only Onduline Classic grade sheets are suitable for use with the market leading Ondutile tile and slate underlay roofing system. This unique system allows tiles to be safely used below the manufacturers minimum recommended roof pitch and benefits from system BBA certification.

Note: The **Ondutile leaflet** should be consulted for detailed fixing specifications.

[Return to Contents](#)

Other Instructional leaflets



ONDUVILLA TILES

Onduvilla tile strips are produced with a unique three tone colour in an attractive 'bold roll' tile profile. This recreates the warm natural colours that are normally only associated with expensive and heavy clay roof finishes. Onduvilla is produced in an easy to handle and fix tile strip format, making them the ideal roof covering for a wide range timber framed garden and commercial buildings.



BARDOLINE SHINGLES

Bardoline tile strip shingles enhance both the style, durability and roof performance of housing, domestic and commercial building projects. Its lightweight, ease of use and fixing allied to its proven versatility make Bardoline the natural choice for a wide range of building projects.



ONDULINE MINI 18 SHEETS

Onduline Mini 18 sheets are designed with a low profile corrugation which compliments perfectly the scale of sheds, summer houses, workshops and garages. Making Mini 18 the ideal 'Do it Once' upgrade to your garden and timber frame buildings.

Mini profile sheets are also the only approved sheet for use with the Ondutile 'low line' tile underlay system.

MAINTENANCE

To ensure a long service life for your shingles the roof should be cleaned regularly of leaves and debris, as leaf mould can reduce the service life of the product. Also check that tree and shrub overhanging branches are not into contact with the surface of the roof; as wind generated movement can cause surface damage.

TERMS AND CONDITIONS

Although the colouring process in the manufacture of the Onduline products are long lasting, as with similar natural roofing materials it is subject to the effects of weathering over its lifetime. The colour can also differ between production batches.

Copyright © 2016 All rights reserved. No part of this publication may be reproduced, distributed, or transmitted in any form or by any means, including photocopying, recording, or other electronic or mechanical methods, without the prior written permission of Onduline Building Products Ltd.



www.onduline.co.uk

Onduline Building Products Ltd

Eardley House, 182-184 Campden Hill Road,
Kensington, London, W8 7AS

Tel: 020 7727 0533

Fax: 020 7792 1390

E-mail: enquiries@onduline.net

[Return to Contents](#)