



PAGUREK

**PRODUCT
CATALOGUE**

 **BLACHOTRAPEZ**

Manufacturer Of Roof Coverings



PAGUREK

The logo for BLACHOTRAPEZ features a stylized blue roofline icon on the left, followed by the word "BLACHOTRAPEZ" in a bold, sans-serif font. The letters "BLACHO" are red and "TRAPEZ" are blue. A solid blue horizontal line is positioned below the text.

BLACHOTRAPEZ

Innovation. Highest quality of products. Creating new utility models. These are key aspects of development of BLACHOTRAPEZ. These are also values, which determine the rhythm of everyday work of our specialists. As the leader in the production of roof and facade coverings in Poland, the company with 40-year experience, we guarantee the greatest care of production process. Our experts ensure that the work is perfect from design stage, through the selection of materials and colours, production to the installation.

The covering materials by BLACHOTRAPEZ mean precision in every detail and the highest quality confirmed by written warranty for even 40 years. The reputation of BLACHOTRAPEZ's products is also supported by the quality of raw materials - the company only cooperates with the best suppliers and is a general distributor of the highest quality coverings from the steel mill thyssenkrupp Steel Europe or TATA Steel.

We do all this in order to fulfil the dreams about ideal house with you. The house covered by beautiful, rigid roof, which provides safety and comfort for the whole family.

COMPANY	03
ROOF TILES	05
TYSENIA	06
ESTIMA	08
ENIGMA	10
GERMANIA	12
GERMAN	14
TALIA	16
DIAMENT	18
KINGAS	20
JANOSIK	22
ROOF PANELS	25
High-Tech	26
Retro 25, Retro 38	28
TROUGHED METAL SHEETS	31
T-8, T-14+, T-18	32
T-18+, T-20+	34
T-35+	37
T-50, T-55	38
STEEL RAILS	40
COLOURS	42
INPUT MATERIAL	44
INNOVATIONS	52
DEDICATED FITTINGS	53
TRANSPORT	54



ROOF TILES

LIGHT ROOF COVERAGE

Metal tiles are the universal roof coverage, which can be easily applied in various types of architecture. Metal tiles are eagerly chosen by investors, both in new building and renovations. The light weight of roof sheets is their particular advantage. 1 sq m of sheet weighs approx 4kg, that is almost 10 times less than traditional ceramic roof tiles. The light coverage neither burden nor affect the structure of the entire building

Thus, the roof sheets are the most frequently applied solution in residential, sacral, farm and public utility buildings. Designed as classic roof tiles, the products from our portfolio, such as GERMANIA SIMETRIC, GERMAN SIMETRIC, DIAMENT, KINGAS, TALIA, JANOSIK and TYSENIA combine tradition with modernity.

The fully automated production process allows for cutting sheets to the required length and therefore the delivery of most unusual orders, accompanied by a reduction of waste.

We offer roof sheets in over ten colours, coated with polyester, PLADUR® EcoProtect thyssenkrupp, aluminium and Colorcoat HPS200 Ultra® TATA Steel. The highest quality of coverage is ensured by complete systems of finishing elements, processing, flat sheets, seals and fixing accessories.



TYSENIA®



TECHNICAL PARAMETERS

Overall width	~1236 mm
Effective coverage width	1198 mm
Thickness of the finished product (steel)	0,5 mm
Tile rib height	30 mm
Module length	350 mm
Profile height	2,5 mm

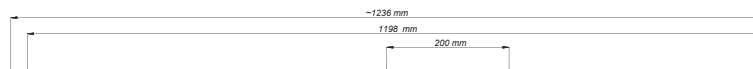

scan the QR code to view a 3D model

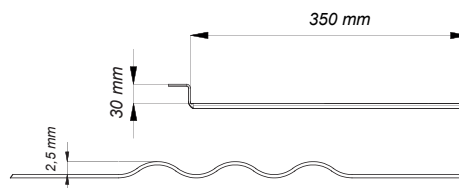

Available in the following coats:



Pladur®
Wrinkle mat



Pladur®
Relief IceCrystal



Colorcoat
HPS 200 Ultra®



Aluminium STUCCO
/MAT Corase



FLAT ROOF TILES

Single-module roof sheet TYSENIA is a modern roof solution for investors searching for exceptional visual effect of roof surfaces. The minimalist, strict look of roof sheet is harmonized with current architectonic trends and flat shape guarantees universal application. A simple form of TYSENIA is decorated by sophisticated triple rib, and its distinctive feature is low, 2,5 mm, profile. TYSENIA may be installed both as roof coverage and original facade finishing.

NEW

What's more, a flat roof sheet is light. Thanks to its lightness, it will be ideal not only for modern building, but also renovations of old buildings' roofs. The product is available in 4 coats, both in matt and gloss: Pladur® Wrinkle MAT, Pladur® Relief IceCrystal thyssenkrupp, Colorcoat HPS200 Ultra® and in rich range of colours.



thyssenkrupp





estima

TECHNICAL PARAMETERS

Overall width	~1191 mm
Real coverage width	1157 mm
Finished product thickness (steel)	0,5 mm
Finished product thickness (aluminium)	0,6 mm
Min. sheet length	720 mm
Max. sheet length	4920 mm
Rib height	35 mm
Module length	350 mm
Profile height	17,5 mm
Wavelength	289 mm

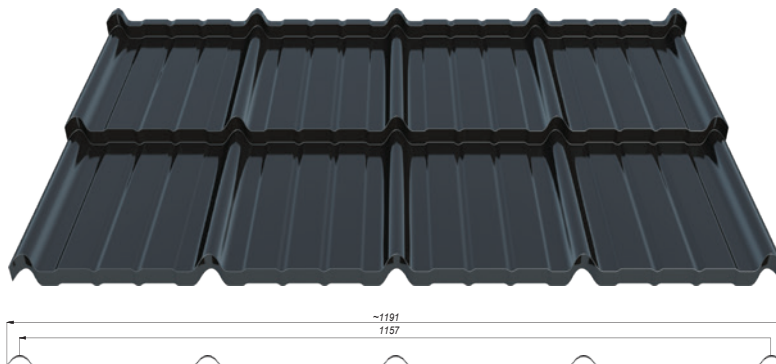

NEW

Available in the following coats:



Pladur® Wrinkle mat
/Pladur® RAL Premium



Pladur® Relief IceCrystal



SUPERIOR HB



Colorcoat HPS 200 Ultra®



Poliester Standard (RAL/MAT)



60 Pladur® Wrinkle Mat Plus



Aluminium STUCCO
/MAT Corase



Super Poliester Standard R-MAT

OUT OF RESPECT FOR INNOVATION

ESTIMA - new, symmetrical flat tile, made of materials that guarantee quality, safety and comfort. Created for the most demanding customers. It is available in many colors and coatings, thanks to which it has wide configuration possibilities. Depending on the choice of protective coating, the manufacturer gives the product a warranty of up to 60 years. In a meeting with ESTIMA, the impression of solidity comes to mind involuntarily. The design will fit very well into both simple and more complicated roof constructions.

ESTIMA

The materials used for the production of ESTIMA tiles ensure durability and protection of the house covering against weather conditions such as rain, snow or wind.

The embossing height is 35 mm and the module length is 350 mm. Thanks to such a construction, the tiles are extremely stiff and create an interesting form. Availability in a modular version guarantees efficient transport and convenient assembly.





ENIGMA

TECHNICAL PARAMETERS

Overall width	~1176 mm
Real coverage width	1100 mm
Finished product thickness (steel)	0,5 mm
Finished product thickness (aluminium)	0,6 mm
Min. sheet length	720 mm
Max. sheet length	max 5970 mm
Rib height	30 mm
Module length	350 mm
Profile height	26 mm
Wavelength	220 mm

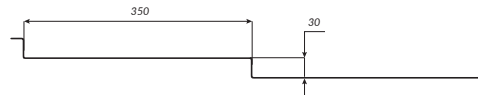
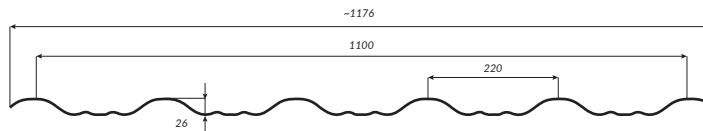

scan the QR code to view a 3D model

Available in the following coats:



Pladur® Wrinkle mat /Pladur® RAL Premium



Pladur® Relief IceCrystal



SUPERIOR HB



Colorcoat HPS 200 Ultra®



Poliester Standard (RAL/MAT)



60 Pladur® Wrinkle Mat Plus



Aluminium STUCCO /MAT Corase



Super Poliester Standard R-MAT

ENIGMA

Enigma can sneak upon you even when you expect to be amazed. The first surprise is the combination of classics and modernity. The technology is available in most coatings offered by Blachotrapez. Thanks to stamping in the SPS system connected with Pladur® Wrinkle Mat Plus coating, customers receive up to 50 years of written warranty. The symmetrical profile of Enigma is unique and becomes particularly attractive in black and brick-red colours.

Interestingly, Enigma has been tailored to fulfill the expectations of the most demanding roofers. Thanks to its symmetry, it can be laid from left to right, from right to left, or arranged in a running bond pattern.

BREAKING SPACE-TIME CONTINUUM

The arrangement can be adapted to the specific roof and made according to your own inspiration. Enigma continues to surprise not only roofers, but also homeowners and onlookers, who can admire the roof from every perspective. The innovative technology of stiffening sheets by using a bottom shelf in combination with other product features makes it currently unrivalled on the market. However, one thing should be no surprise to our customers, as it is the feature connecting all Blachotrapez products: extraordinary diligence in the selection of high-quality materials and matching modern technological solutions. Enigma has already entered with bravado into roofing classics for many generations.





GERMANIA

simetric

TECHNICAL PARAMETERS

Overall width	~1215 mm
Effective coverage width	1120 mm
Thickness of the finished product (steel)	0,5 mm
Finished product thickness (aluminium)	0,6 mm
Recommended length	max 5970 mm
Tile rib height	25/30 mm
Module length	350 mm
Profile height	20 mm



scan the QR code to view a 3D model

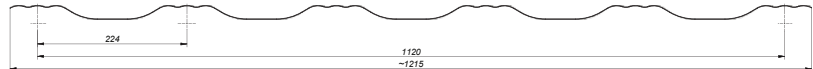

Available in the following coats:



Pladur® Wrinkle mat /Pladur® RAL Premium



Pladur® Relief IceCrystal



SUPERIOR HB



Colorcoat HPS 200 Ultra®



Poliester Standard (RAL/MAT)



60 Pladur® Wrinkle Mat Plus



Aluminium STUCCO /MAT Corase



Super Poliester Standard R-MAT

GERMANIA SIMETRIC

Considering the needs of our Customers, we take care of the highest quality of the offered products. Our products' reputation is also confirmed by the quality of raw materials supplied by the best steel mills, such as: thyssenkrupp Steel Europe and TATA Steel as well as U.S. Steel. It is the material, used in the production, that makes the model of roof sheet GERMANIA SIMETRIC characterized by increased resistance to abrasion, staining and corrosion.

When designing the roof sheet GERMANIA, we focus on sleek look, durability and economics.

DURABLE AND BEAUTIFUL ROOF

This innovative and exceptional product is distinguished by a higher profile and a unique triple rib, giving the coverage distinct and timeless character and unconventional look. Utility model of roof sheet GERMANIA SIMETRIC is protected by the Office for Harmonisation in the Internal Market of the European Union. Design no.: 002495606-0001. The written warranty for roof sheets, depending on the type of coat, may even cover the period up to 40 years.



thyssenkrupp



GERMAN
simetric

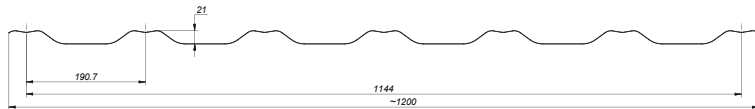

GERMAN 30/40

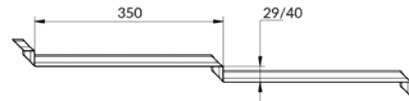

TECHNICAL PARAMETERS

Overall width	~1200 mm
Effective coverage width	1144 mm
Thickness of the finished product (steel)	0,5 mm
Finished product thickness (aluminium)	0,6 mm
Recommended length	max 5970 mm
Tile rib height	29/40 mm
Module length	350 mm
Profile height	21 mm



scan the QR code to view a 3D model

Available in the following coats:



Pladur® Wrinkle mat /Pladur® RAL Premium



Pladur® Relief IceCrystal



SUPERIOR HB



Colorcoat HPS 200 Ultra®



Poliester Standard (RAL/MAT)



60 Pladur® Wrinkle Mat Plus



Aluminium STUCCO /MAT Corase



Super Poliester Standard R-MAT

GERMAN SIMETRIC

GERMAN SIMETRIC is a symmetric, modular roofing sheet, that our Customers will like for its modern and attractive look, and by roofers - for the ease of assembly. A great advantage of GERMAN SIMETRIC is a high-quality raw material - in its production, Blachotrapez uses steel coming from German steelworks of thyssenkrupp Steel Europe, a world leader in this sector. Made of the best raw material, the GERMAN SIMETRIC roofing sheet has increased resistance to abrasion and soiling, as well as the highest anti-corrosion resistance on the Polish market.

PRECISION TAILORED TO YOUR ROOF

Precision, solidity and classic beauty. When it comes to a few words about the new GERMAN SIMETRIC roofing sheet, such is the summary of its character. Now, even complicated roofing constructions will be a reliable protection for you and your family for long years to come.



thyssenkrupp



TECHNICAL PARAMETERS

Overall width	~1210 mm
Effective coverage width	1150 mm
Thickness of the finished product (steel)	0,5 mm
Finished product thickness (aluminium)	0,6 mm
Recommended length	max 5970 mm
Tile rib height	30/35 mm
Module length	350 mm
Profile height	19 mm

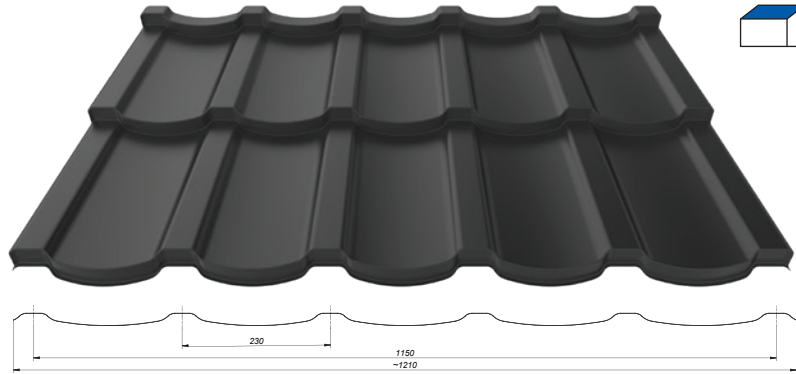

scan the QR code to view a 3D model

TALIA 30/35

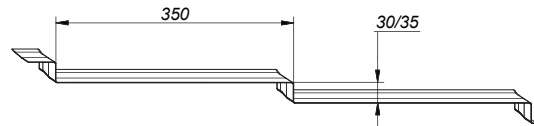

Available in the following coats:



Pladur® Wrinkle mat /Pladur® RAL Premium



Pladur® Relief IceCrystal



SUPERIOR HB



Colorcoat HPS 200 Ultra®



Poliester Standard (RAL/MAT)



60 Pladur® Wrinkle Mat Plus



Super Poliester Standard R-MAT



Aluminium STUCCO /MAT Corase

NEW DIMENSION OF ROOFING WITH TALIA 30 i 35 mm

TALIA 30 is a roofing sheet well known for its slender form. Now, it is available also in a new version, with a higher crease - 35 mm. The new TALIA 35 still means a beautiful shape, now with a reinforcement of the original crease, which offers new possibilities for shaping large and small roof surfaces. Unconventional finish of the lower edge of the sheet cut along the shape of the profile, called a 3D finish, enhances additionally the aesthetics of the design. We recommend combining TALIA with the SUPERIOR HB premium class coating with a polish guaranteeing an exquisite visual effect created by the coating.

DISCOVER A WHOLE PACKAGE OF ADVANTAGES FOR YOUR ROOF

In order to achieve an extraordinary strength that will last for years, we recommend TALIA with the Pladur® Wrinkle Mat Plus coating. The coating is 50 µm thick and has a high content of zinc and magnesium. Its high quality parameters are certified and backed by a written 50-year guarantee of the manufacturer. Additionally, both Talia models may be purchased with all coatings offered by BLACHOTRAPEZ.



thyssenkrupp



TECHNICAL PARAMETERS

Overall width	~1150 mm
Effective coverage width	1045 mm
Thickness of the finished product (steel)	0,5 mm
Finished product thickness (aluminium)	0,6 mm
Recommended length	max 5750 mm
Tile rib height	20 mm
Module length	350 mm
Profile height	34 mm



scan the QR code to view a 3D model

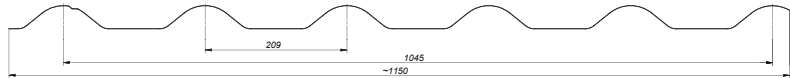

TECHNICAL PARAMETERS

Overall width	~1200 mm
Effective coverage width	1120 mm
Thickness of the finished product (steel)	0,5 mm
Finished product thickness (aluminium)	0,6 mm
Recommended length	max 5750 mm
Tile rib height	14 mm
Module length	350/400 mm
Profile height	22 mm



scan the QR code to view a 3D model



DIAMENT PLUS and DIAMENT ECO PLUS

The traditional pattern of Diamond Plus roof tiles contributes to the covered roof's characteristic look, which is bound to attract attention. This model was designed to perfectly adhere and minimize the amount of waste sheets.

Available in the following coats:



Pladur® Wrinkle mat /Pladur® RAL Premium



Pladur® Relief IceCrystal



SUPERIOR HB



Colorcoat HPS 200 Ultra®



Poliester Standard (RAL/MAT)



60 Pladur® Wrinkle Mat Plus



Aluminium STUCCO /MAT Corase



Super Poliester Standard R-MAT



thyssenkrupp



TECHNICAL PARAMETERS

Overall width	~1195 mm
Effective coverage width	1100 mm
Thickness of the finished product (steel)	0,5 mm
Finished product thickness (aluminium)	0,6 mm
Recommended length	max 5750 mm
Tile rib height	14/20 mm
Module length	350/400 mm
Profile height	23 mm



scan the QR code to view a 3D model

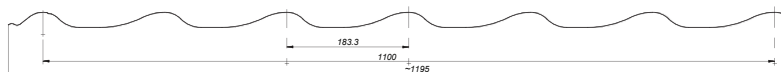

TECHNICAL PARAMETERS

Overall width	~1195 mm
Effective coverage width	1120 mm
Thickness of the finished product (steel)	0,5 mm
Thickness of the finished product (aluminium)	0,6 mm
Recommended length	max 5750 mm
Tile rib height	14 mm
Module length	350 mm
Profile height	22 mm



scan the QR code to view a 3D model

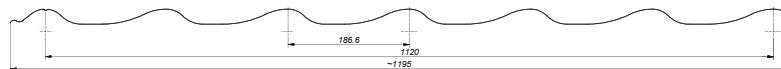

KINGAS and KINGAS ECO PLUS

Roofing sheet KINGAS and KINGAS ECO PLUS is an elegant, light roof covering, standing out due to its attractive design resembling delicate waves. It is suitable for all kinds of houses and apartment, religious, utility and public utility buildings.

Available in the following coats:



Pladur® Wrinkle mat /Pladur® RAL Premium



Pladur® Relief IceCrystal



SUPERIOR HB



Colorcoat HPS 200 Ultra®



Poliester Standard (RAL/MAT)



60 Pladur® Wrinkle Mat Plus



Aluminium STUCCO /MAT Corase



Super Poliester Standard R-MAT



thyssenkrupp



TECHNICAL PARAMETERS

Overall width	~1222 mm
Effective coverage width	1180 mm
Thickness of the finished product (steel)	0,5 mm
Tile rib height	35 mm
Module length	380 mm
Profile height	6 mm



scan the QR code to view a 3D model

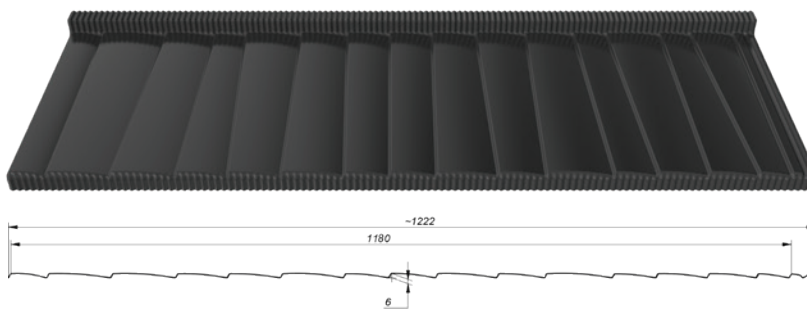

Available in the following coats:



Pladur®
Relief Textured Wood



THE JANOSIK METAL SHINGLE

The JANOSIK metal shingle is an innovative product with unique design. Its form, texture and appearance thoroughly resemble the wooden shingle. This effect was achieved thanks to innovative technological solutions of the machinery park and the development of basic material PLADUR Relief Textured Wood.

The PLADUR Relief Textured Wood coat, designed in resemblance of wood, imitates perfectly its texture and provides a unique visual effect on the roof. High-quality German steel, used for the production of JANOSIK, is from a renowned steel mill thyssenkrupp Steel Europe, a leader of the global market. Thanks to the securing of the steel core with a mix of zinc and magnesium, metal sheet has a greater durability, and its lifespan has been prolonged.

TRADITIONAL WOODEN LOOK IN STEEL FORM

The product's incredible appearance has been achieved by adding texture and paint coats. An exceptional durability of paint coats is provided by at least 36 µm. The JANOSIK metal shingle is highly resistant to corrosion, abrasion, staining and UV radiation. Contrary to wooden shingle, this material does not require frequent and costly maintenance and impregnation, and thus is more functional. Thanks to a low profile, coverage width is higher and it improves the product cost effectiveness. The JANOSIK metal shingle is easy and simple to install thanks to the possibility of laying the material on both sides in a brick pattern.

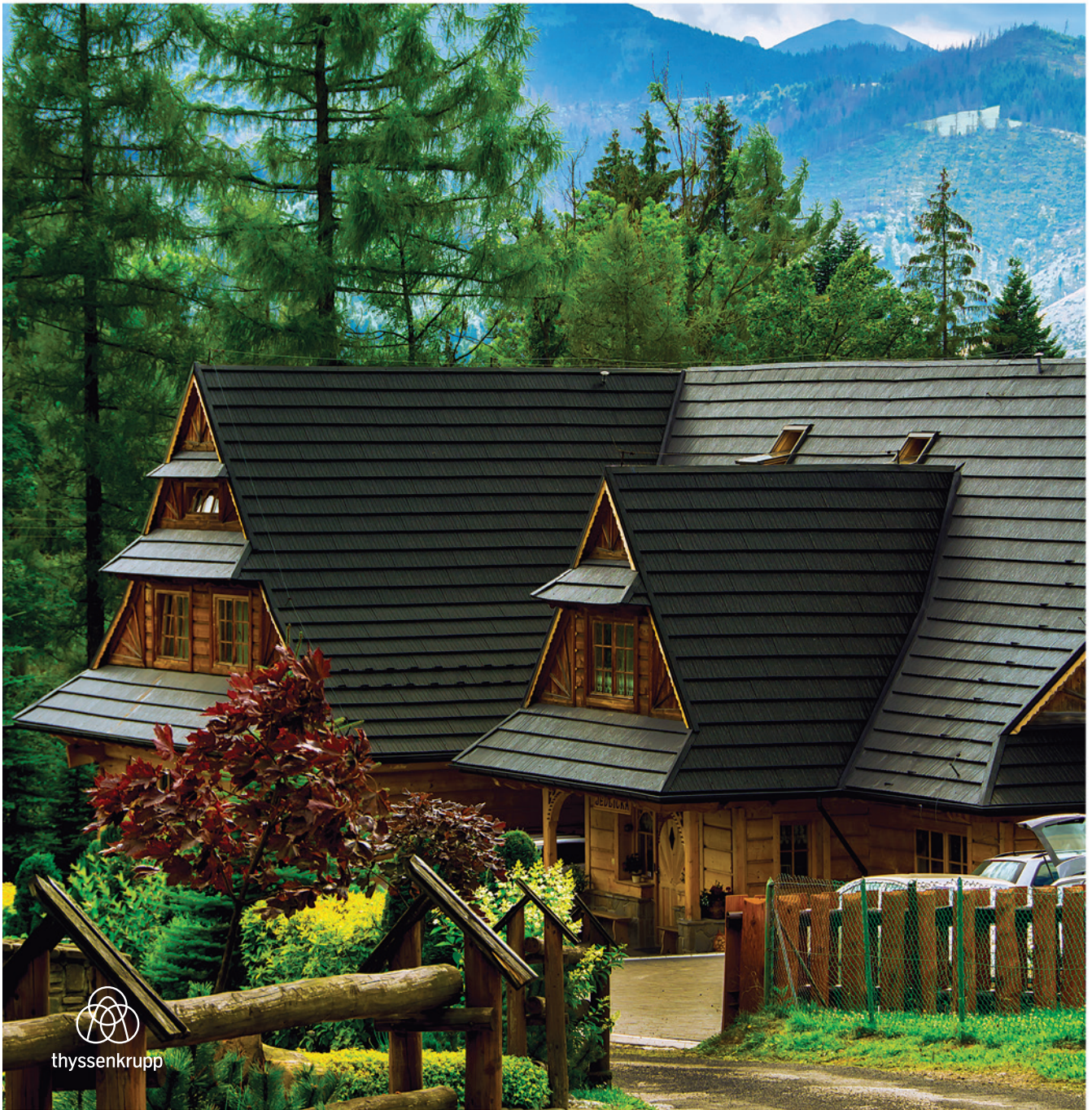

thyssenkrupp

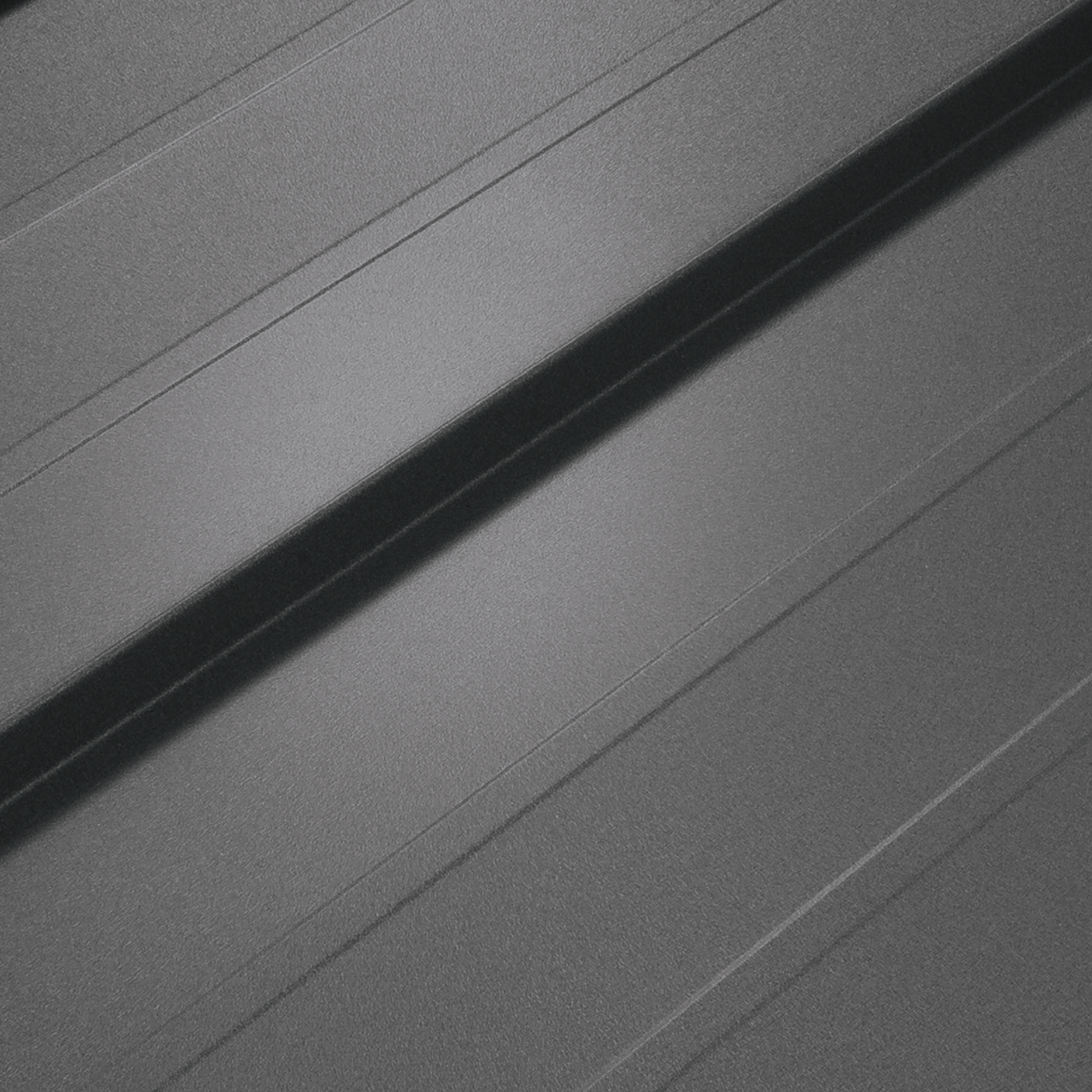



ROOF PANELS

CLASSIC LOOK MODERN FORM

Standing seal roof panel is a solution which refers to the traditional “seam or welt” installation system. The need for innovation made Blachotrapez design a product featuring numerous improvements - the Retro standing seam roof panel. It combines the functionality, simple and quick installation with the exceptional look of the product, which meets the top design standards. The combination of these features in one product provides for great possibility of shaping the roof surface.



PANEL™ HIGH-TECH

TECHNICAL PARAMETERS

Overall width	~528 mm
Effective coverage width	488 mm
Thickness of the finished product (steel)	0,5 mm
Seam height	32 mm
„Clik“ height	27 mm
Sheet length	max 8000 mm

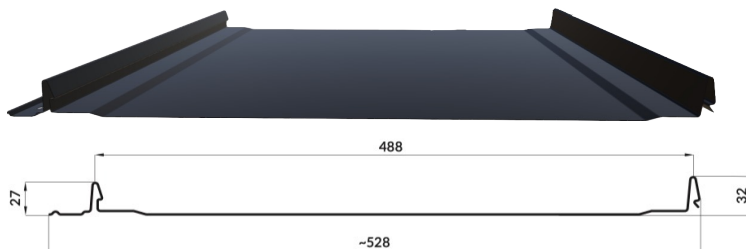

NEW

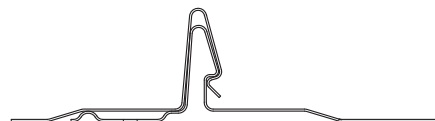

Available in the following coats:



Pladur®
Wrinkle mat



Pladur®
Relief Textured Wood



60 Pladur®
Wrinkle Mat Plus



Pladur®
Relief IceCrystal

ADDITIONAL OPTION:

- Cutting - cutting option for folding
- Cutting with folding - folding option for start piece



Super Polyester
Standard R-MAT

PANEL HIGH TECH

Technological innovation in each area allows to fulfil the desires and needs. The best evidence of this is the HIGH-TECH Panel. It is the result of modern cooperation of roofers, market leaders and Blachotrapez specialists. It redefines the shape of a standing seam roof panel. This is the most advanced technology available on the market - it meets the expectations of roofers, architects and investors implementing bold future projects.

IMPROVED DESIGN FUNCTIONALITY

A special profile external snap lock with optimized height for easy installation. Its design reduces sheet tension. This is the latest snap lock clamping technology available on the market. In addition, a special rise at snap locks provides even contact of the flat panel surface to the substrate and reduces waving.



28 | Roof panel

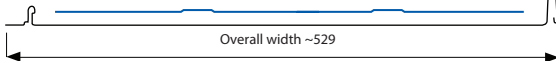
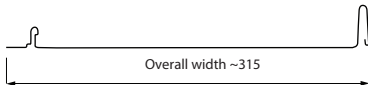
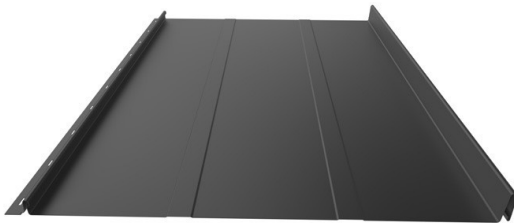
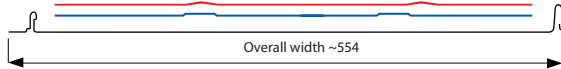
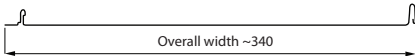
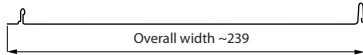
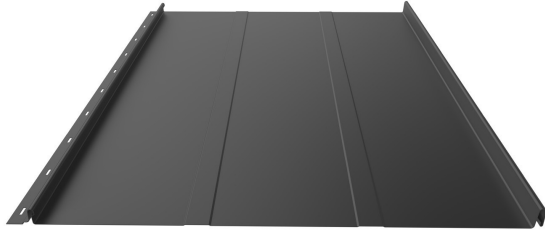

PANEL RETRO 25



scan the
QR code
to view a
3D model



PANEL RETRO 38



scan the
QR code
to view a
3D model

Seam height **25 mm**
Effective coverage width **521/309/209**
Overall width **~554/~340/~239**
Thickness of the finished

Thic

m

Available



Pladi
/Plac

a®



Pladi
Relief

(MAT)



Pladur®
Relief Textured Wood



Aluzinc



Pladur®
Wrinkle Mat Plus



SUPERIOR HB



Aluminium STUCCO
/MAT Corase



Super Poliester
Standard R-MAT

Seam height **38 mm**
Effective coverage width **498/284**
Overall width **~529/~315**

Thickness of the finished
product (steel) **0,5 mm**

Thickness of the finished
product (aluminium) **0,6 mm**
Sheet length **max 8000 mm**

Available in the following coats:



Pladur® Wrinkle mat
/Pladur® RAL Premium



Colorcoat
HPS 200 Ultra®



Pladur®
Relief IceCrystal



Poliester
Stand. (RAL/MAT)



Pladur®
Relief Textured Wood



Aluzinc



Pladur®
Wrinkle Mat Plus



SUPERIOR HB



Aluminium STUCCO
/MAT Corase



Super Poliester
Standard R-MAT

ADDITIONAL OPTION:

- Ribs
- Cutting - cutting option for folding
- Cutting with folding - folding option for start piece



thyssenkrupp





TROUGHED ROOF SHEET

TRADITIONAL ROOF AND FACADE COVERAGE

Troughed roof sheets are exceptional due to their distinctive shape and simplicity. It is a universal and economic material for fast coverage of both roofs and facades. It allows for erecting impressive structures which break the traditional division between roof and facade. Troughed roof sheets are eagerly selected by constructors as material for roof of industrial and public buildings. The owners of single-family houses also more often decide to use the troughed roof sheet, as such roof sheet perfectly presents on the building with modern, minimalistic architecture and environmentally friendly style.

Troughed roof sheets are above all practical. Thanks to a wide range of sheet thickness in, tailored cutting service and abundant colour selection, its applications are unlimited. As an important feature, its rigidity and durability is determined by the profile height.

For small and medium-size buildings, the following troughed sheet profiles will be the best: T8, T14 plus, T18, T18 plus, T20 plus, T35, T35 plus, T50, T55. T50 and T55 sheet metal plates are used in large commercial buildings, such as production halls.



T-8

TECHNICAL PARAMETERS

Overall width ~1195 mm
 Effective coverage width 1170 mm
 Thickness of the finished product (steel) 0,4-0,5 mm
 Recommended length max 6 rm



scan the QR code to view a 3D model

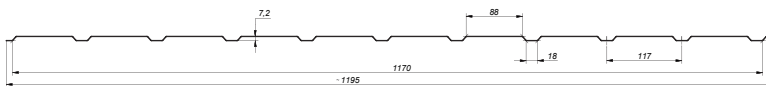

Available in the following coats:

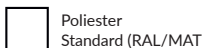
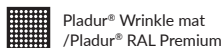

T-14+

TECHNICAL PARAMETERS

Overall width ~1149 mm
 Effective coverage width 1111 mm
 Thickness of the finished product (steel) 0,5-0,7 mm
 Recommended length max 8 rm



scan the QR code to view a 3D model

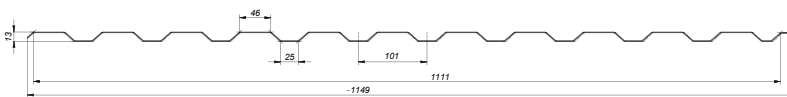
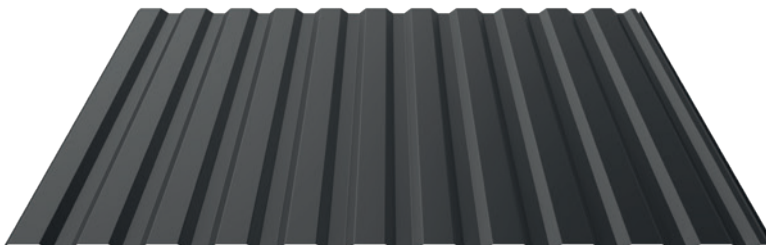

Available in the following coats:

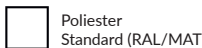
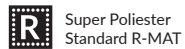

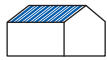

T-18

TECHNICAL PARAMETERS

Overall width ~1160mm
 Effective coverage width 1123 mm
 Thickness of the finished product (steel) 0,5-0,75 mm
 Recommended length max 10 rm



scan the QR code to view a 3D model

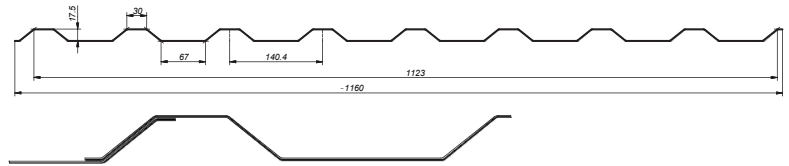
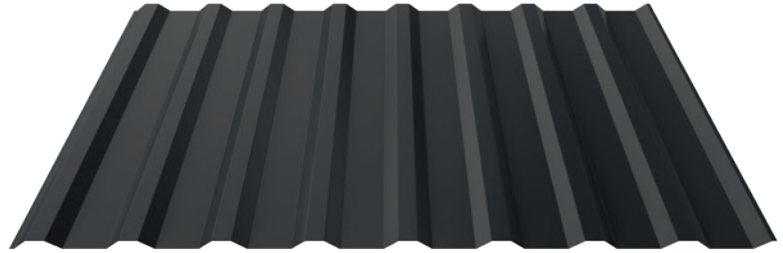

Available in the following coats:

-  Pladur® Wrinkle mat /Pladur® RAL Premium
-  Pladur® Relief IceCrystal
-  SUPERIOR HB
-  Colorcoat HPS 200 Ultra®
-  Polier Standard (RAL/MAT)
-  60 Pladur® Wrinkle Mat Plus
-  Aluzinc
-  Super Polier Standard R-MAT
-  Aluminium STUCCO /MAT Corase

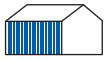

T-18

TECHNICAL PARAMETERS

Overall width ~1160 mm
 Effective coverage width 1123 mm
 Thickness of the finished product (steel) 0,5-0,75 mm
 Recommended length max 10 rm



scan the QR code to view a 3D model

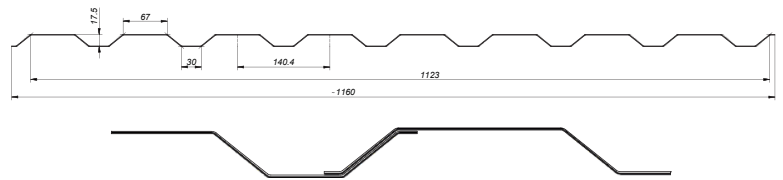
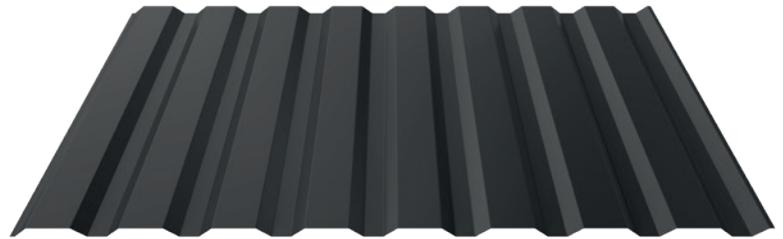

Available in the following coats:

-  Pladur® Wrinkle mat /Pladur® RAL Premium
-  Pladur® Relief IceCrystal
-  SUPERIOR HB
-  Colorcoat HPS 200 Ultra®
-  Polier Standard (RAL/MAT)
-  60 Pladur® Wrinkle Mat Plus
-  Aluzinc
-  Super Polier Standard R-MAT
-  Aluminium STUCCO /MAT Corase



T-18+

TECHNICAL PARAMETERS

Overall width ~1173 mm
 Effective coverage width 1127 mm
 Thickness of the finished product (steel) 0,5-0,75 mm
 Thickness of the finished product (aluminium) 0,6 mm
 Recommended length max 12 rm



scan the QR code to view a 3D model

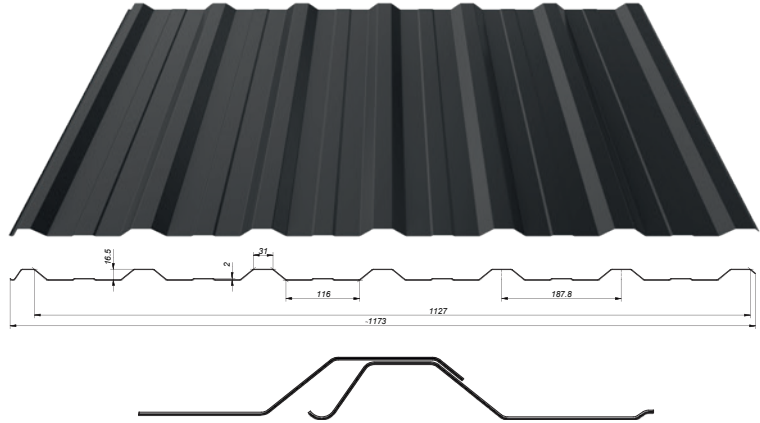

Available in the following coats:

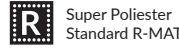
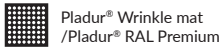

T-18+

TECHNICAL PARAMETERS

Overall width ~1173 mm
 Effective coverage width 1127 mm
 Thickness of the finished product (steel) 0,5-0,75 mm
 Thickness of the finished product (aluminium) 0,6 mm
 Recommended length max 12 rm



scan the QR code to view a 3D model

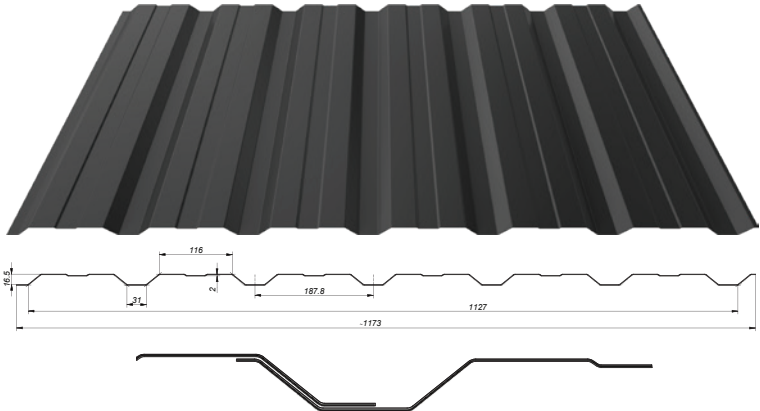

Available in the following coats:

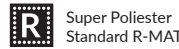
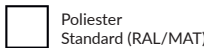
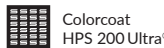

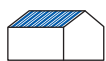

T-20⁺

TECHNICAL PARAMETERS

Overall width	~1120 mm
Effective coverage width	1070 mm
Thickness of the finished product (steel)	0,5-0,75 mm
Thickness of the finished product (aluminium)	0,6 mm
Recommended length	max 12 rm



scan the QR code to view a 3D model

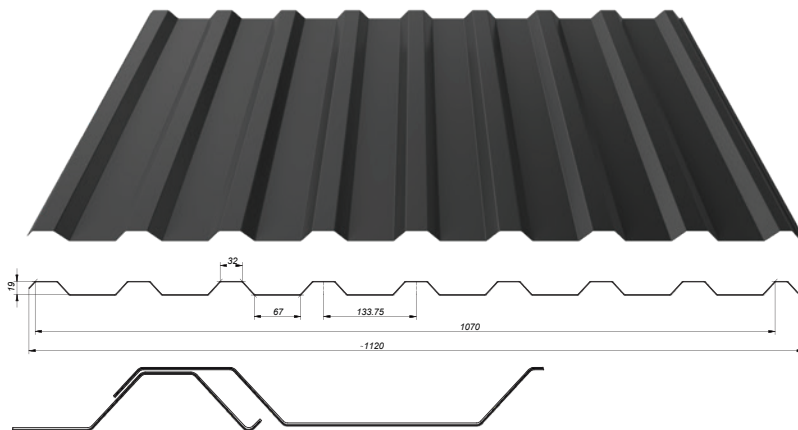

Available in the following coats:

-  Pladur® Wrinkle mat /Pladur® RAL Premium
-  Pladur® Relief IceCrystal
-  SUPERIOR HB
-  Colorcoat HPS 200 Ultra®
-  Poliester Standard (RAL/MAT)
-  60 Pladur® Wrinkle Mat Plus
-  Aluzinc
-  Super Poliester Standard R-MAT
-  Aluminium STUCCO /MAT Corase



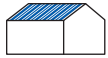

T-35+

TECHNICAL PARAMETERS

Overall width ~1100 mm
 Effective coverage width 1065 mm
 Thickness of the finished product (steel) 0,5-1 mm
 Recommended length max 12 rm



scan the QR code to view a 3D model

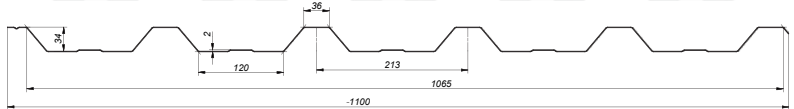
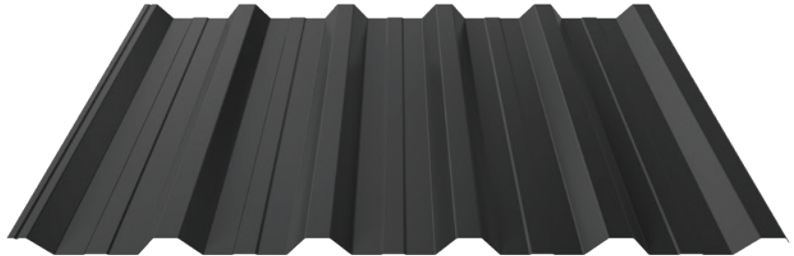

R Super Polyester Standard R-MAT

Available in the following coats:

-  Pladur® Wrinkle mat /Pladur® RAL Premium
-  Pladur® Relief IceCrystal
-  SUPERIOR HB
-  Colorcoat HPS 200 Ultra®
-  Polyester Standard (RAL/MAT)
-  **60** Pladur® Wrinkle Mat Plus
-  Aluzinc



T-35+

TECHNICAL PARAMETERS

Overall width ~1100 mm
 Effective coverage width 1065 mm
 Thickness of the finished product (steel) 0,5-1 mm
 Recommended length max 12 rm



scan the QR code to view a 3D model

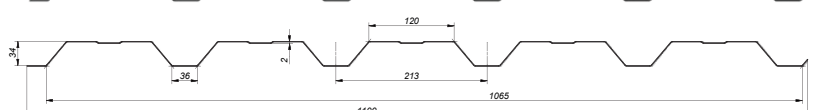
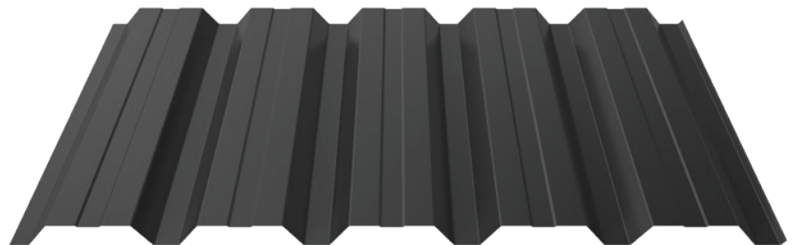

R Super Polyester Standard R-MAT

Available in the following coats:

-  Pladur® Wrinkle mat /Pladur® RAL Premium
-  Pladur® Relief IceCrystal
-  SUPERIOR HB
-  Colorcoat HPS 200 Ultra®
-  Polyester Standard (RAL/MAT)
-  **60** Pladur® Wrinkle Mat Plus
-  Aluzinc

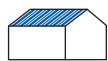

T-50

TECHNICAL PARAMETERS

Overall width ~1098 mm
 Effective coverage width 1047 mm
 Thickness of the finished product (steel) 0,5-1,0 mm
 Recommended length max 12 rm



scan the QR code to view a 3D model

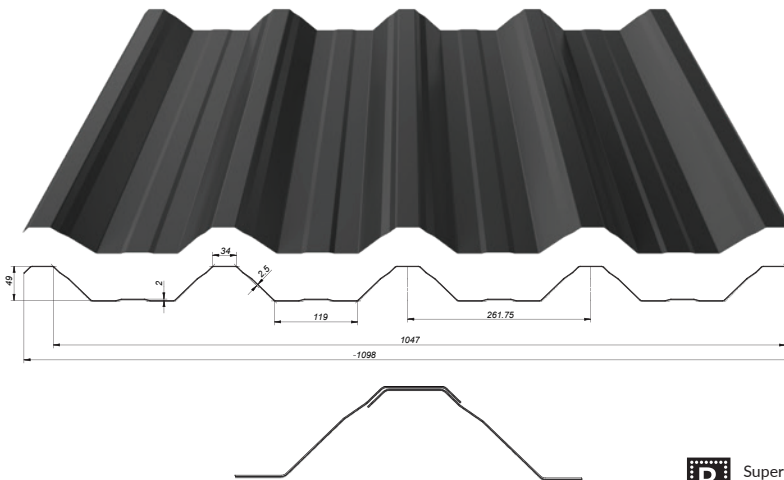

Available in the following coats:

-  Pladur® Wrinkle mat /Pladur® RAL Premium
-  Pladur® Relief IceCrystal
-  SUPERIOR HB
-  Colorcoat HPS 200 Ultra®
-  Poliester Standard (RAL/MAT)
-  60 Pladur® Wrinkle Mat Plus
-  Aluzinc

 Super Poliester Standard R-MAT

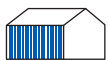

T-50

TECHNICAL PARAMETERS

Overall width ~1098mm
 Effective coverage width 1047 mm
 Thickness of the finished product (steel) 0,5-1,0 mm
 Recommended length max 12 rm



scan the QR code to view a 3D model

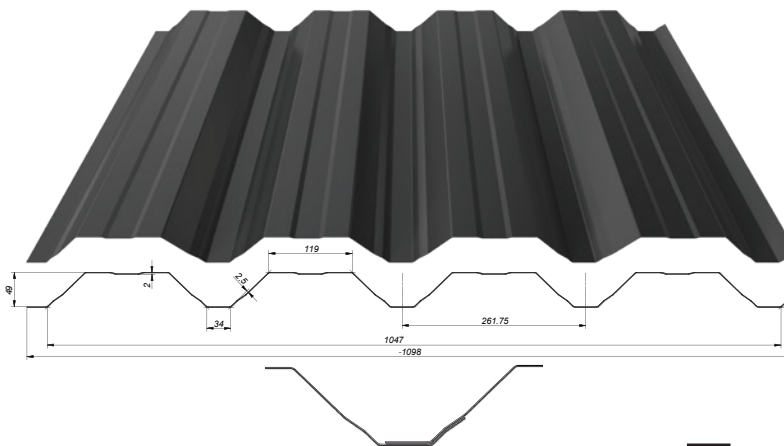

Available in the following coats:

-  Pladur® Wrinkle mat /Pladur® RAL Premium
-  Pladur® Relief IceCrystal
-  SUPERIOR HB
-  Colorcoat HPS 200 Ultra®
-  Poliester Standard (RAL/MAT)
-  60 Pladur® Wrinkle Mat Plus
-  Aluzinc

 Super Poliester Standard R-MAT

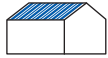

T-55

TECHNICAL PARAMETERS

Overall width ~1050 mm
 Effective coverage width 1000 mm
 Thickness of the finished product (steel) 0,5–1,0 mm
 Recommended length max 12 rm



scan the QR code to view a 3D model

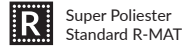
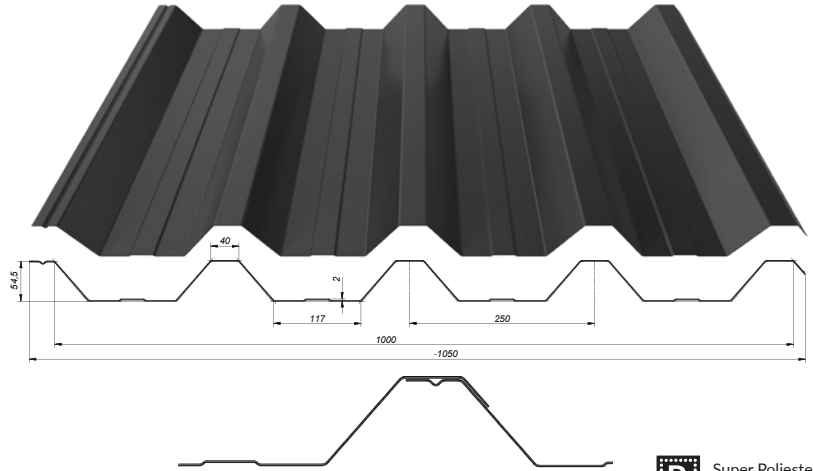

Available in the following coats:

-  Pladur® Wrinkle mat /Pladur® RAL Premium
-  Pladur® Relief IceCrystal
-  SUPERIOR HB
-  Colorcoat HPS 200 Ultra®
-  Polyster Standard (RAL/MAT)
-  60 Pladur® Wrinkle Mat Plus
-  Aluzinc

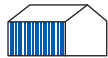

T-55

TECHNICAL PARAMETERS

Overall width ~1050 mm
 Effective coverage width 1000 mm
 Thickness of the finished product (steel) 0,5–1,0 mm
 Recommended length max 12 rm



scan the QR code to view a 3D model

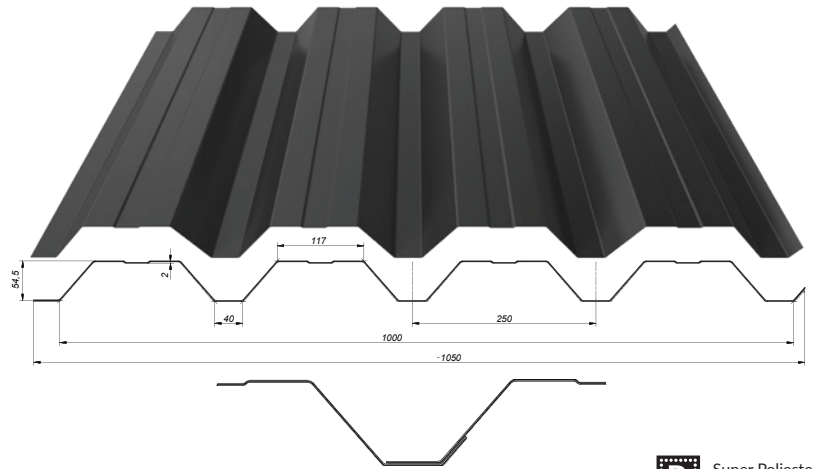

Available in the following coats:

-  Pladur® Wrinkle mat /Pladur® RAL Premium
-  Pladur® Relief IceCrystal
-  SUPERIOR HB
-  Colorcoat HPS 200 Ultra®
-  Polyster Standard (RAL/MAT)
-  60 Pladur® Wrinkle Mat Plus
-  Aluzinc



STEEL RAILS

STEEL RAILS PREMIUM

Eye-catching design - a unique proprietary design patent law, high-quality material, as well as modern and practical assembly solutions are just some of the distinguishing features of the steel rails premium. Fencing with Steel Rail Premium fits in perfectly with the surrounding architecture complement the home environment and emphasizing its character. Based on years of experience in the production of high-quality coated sheets BLACHOTRAPEZ created a product extremely durable and aesthetic of universal design solutions. Steel rails Premium do not burden the construction of the fence and will freely develop its line and choose the optimum height - according to individual needs, and freely adjust headroom fence. The unquestionable advantage of the system is extremely simple and quick installation which can be carried out independently. The advantage is also easy to keep rails clean - that do not require special maintenance.



Steel rail

TECHNICAL PARAMETERS

Profile height	20,9 mm
Charge width	156 mm
Useable width	123 mm
Overall width	123 mm
Element length size	at requested
Max rec. element length	2400 mm
Min element length	150 mm



scan the QR
code to view
a 3D model

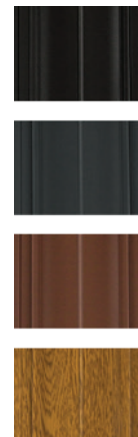
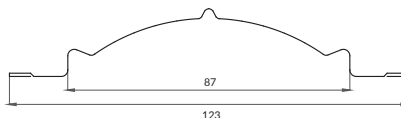
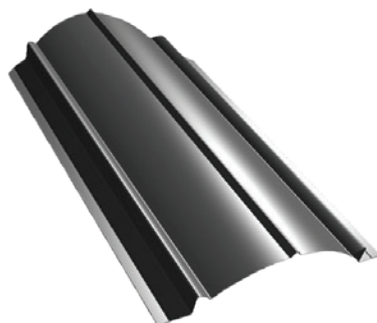

The steel railings are available in two versions: one-side coated or coated on both sides

As for the version with both sides coated, the following colours are available: RAL8017, RAL 9005, RAL 7016 the wood-like GOLDEN OAK

In the one-side coated version: all the raw materials available in the warehouse, with the exception of HPS, OCYNK, ZINKOMAG and ALUZINC





 Pladur®
Relief IceCrystal

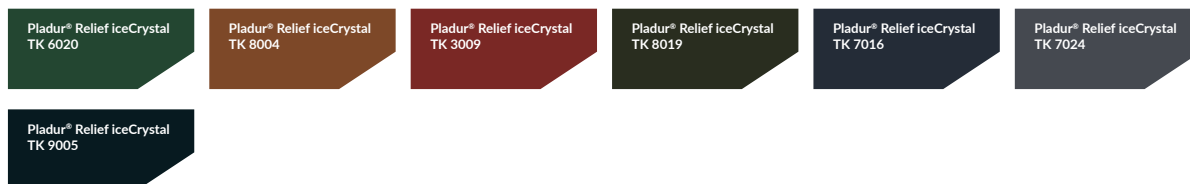

 Pladur® Wrinkle mat



 SUPERIOR HB



 Colorcoat
HPS 200 Ultra®

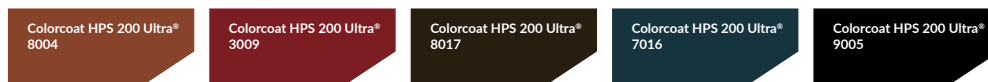

The printing technology does not allow for accurate reflection of coating colours, thus the presented colours are indicative and may differ from actual colours. The colours of samples are subject to production tolerance and may significantly differ from the material delivered to the construction site.



 Poliester
Standard (RAL/MAT)

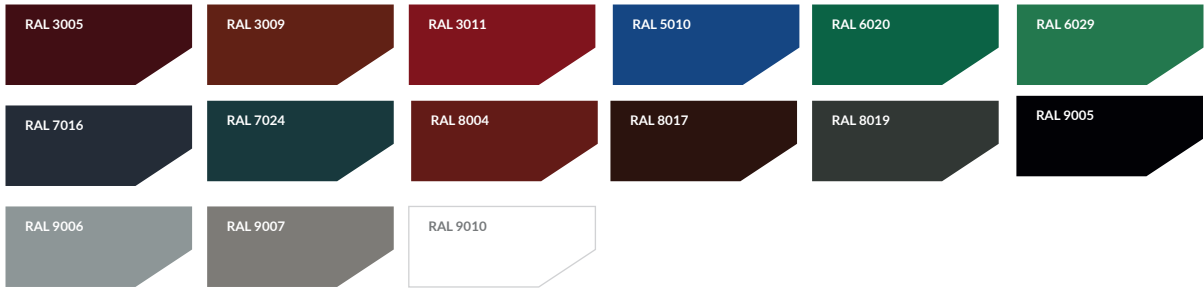

 Pladur®
RAL Premium



 Alucynk

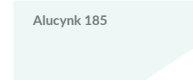

 Super Poliester
Standard R-MAT

60 Pladur®
Wrinkle Mat Plus

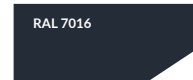
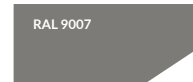
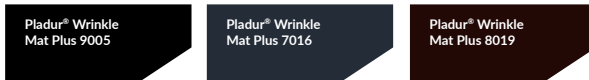

 Aluminium STUCCO
/MAT Corase





60 Pladur®
Wrinkle Mat Plus

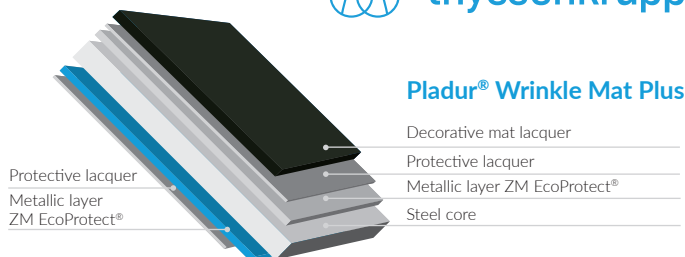

Pladur® Wrinkle Mat Plus - coarse-grained, 2-layer coating system, in colours according to known colour schemes, with layer thickness of min. 50 microns.



 Pladur® Wrinkle mat
/Pladur® RAL Premium

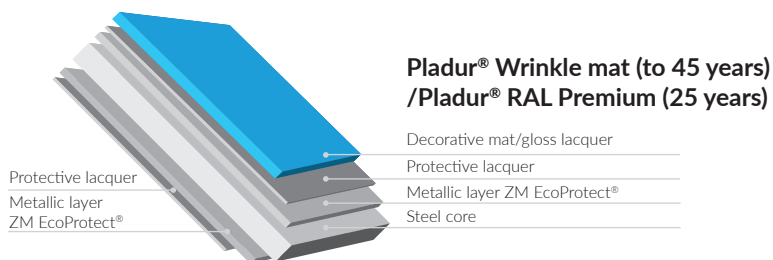

Pladur® Wrinkle mat - thick-grain, double-layer coating system, with colours according to well-known patterns and min. coat thickness 35 microns. The sheets meet the requirements of class A2 in accordance with the Commission Decision 96/603/EC on fire protection and may be used in the corrosion category C4 according to the standard EN ISO 12944-2.



Pladur® Relief IceCrystal

Surface-colouring lacquer

Ice-crystal-structured lacquer

Protective lacquer

Metallic layer ZM EcoProtect®

Steel core

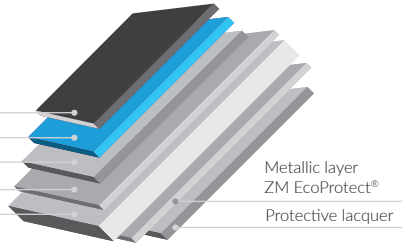

Metallic layer
ZM EcoProtect®

Protective lacquer



Pladur®
Relief IceCrystal

Pladur® Relief IceCrystal - sheets with a proprietary surface structure imitating patterns of frozen ice, triple-layer coating system, min. coat thickness 36 microns. The sheets meet the requirements of class A2 in accordance with the Commission Decision 96/603/EC on fire protection and may be used in the corrosion category C4 according to the standard EN ISO 12944-2.



Pladur® Relief Wood

Surface-colouring lacquer

Wood-structured lacquer

Protective lacquer

Metallic layer ZM EcoProtect®

Steel core

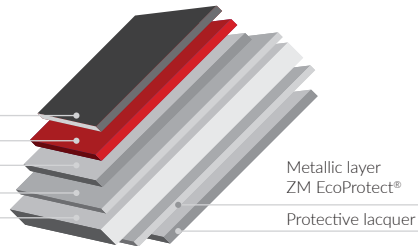

Metallic layer
ZM EcoProtect®

Protective lacquer



Pladur®
Relief Textured Wood

Pladur® Relief Textured Wood - sheets with a proprietary surface structure imitating wood, triple-layer coating system, min. coat thickness 36 microns. The sheets meet the requirements of class A2 in accordance with the Commission Decision 96/603/EC on fire protection and may be used in the corrosion category C4 according to the standard EN ISO 12944-2.

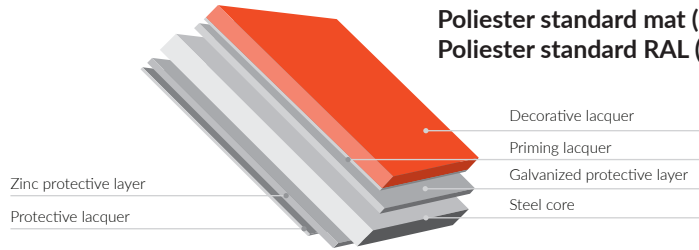

Poliester standard mat (25 years)
Poliester standard RAL (10 years)



 Poliester Standard (RAL/MAT)

Poliester Standard - coated sheets are the most popular option for metal roofing. Currently, sheets that are double-side galvanised with anti-corrosive layer, priming or organic paint are used. The top layer provides the colour and texture, as well as protects against outdoor conditions.

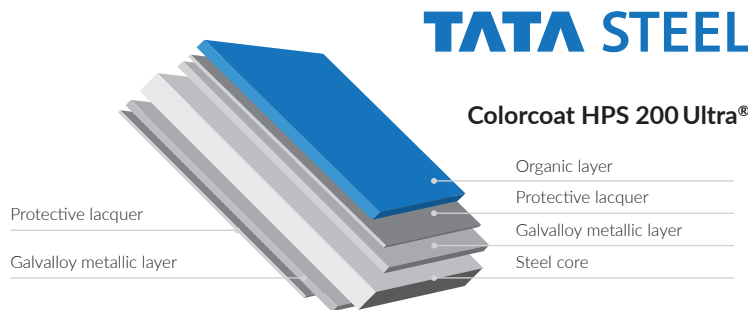

TATA STEEL

Colorcoat HPS 200 Ultra®



 Colorcoat HPS 200 Ultra®

Colorcoat HPS 200 Ultra ®- employs a tested metallic Galvalloy layer which is used exclusively by TATA Steel and is an alloy of 95% zinc with 5% aluminium, ensuring unparalleled protection against corrosion. The thickness of the organic layer in the Colorcoat HPS200 Ultra ®product is 200 µm. The sheets Colorcoat HPS200 Ultra® may be used in the highest corrosion category C5 according to the standard EN ISO 12944-2. Furthermore, if the roofing is made of the sheet Colorcoat HPS200 Ultra®, the external fire performance is classified as B roof (t1), B roof (t2), B roof (t3) and the reaction to fire as C-s2, d0 according to the Commission Decision.

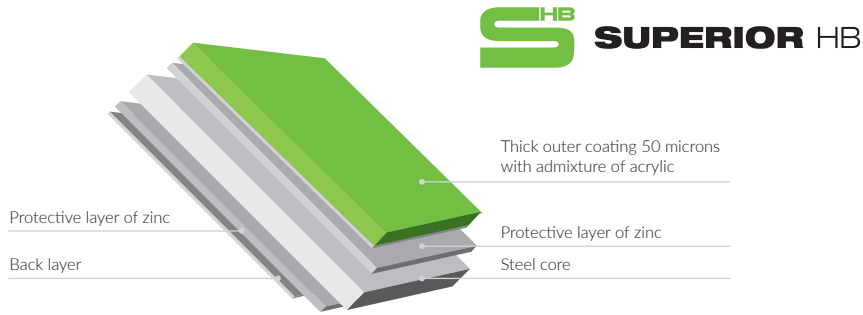

SUPERIOR HB - is a ground-breaking alternative for smooth polyester surface. Thanks to an addition of acrylic compounds, the coat texture is slightly grained and it reflects light with a flickering effect. The acrylic additive additionally hardens the paint surface and ensures higher resistance to scratching. Lacquered sheets with metallic coating SUPERIOR HB meet the requirements of class A1 in accordance with the Commission Decision 96/603/EC on fire protection. The products with SUPERIOR HB coating system may be used in the corrosion category C4 according to the standard EN ISO 12944-2.

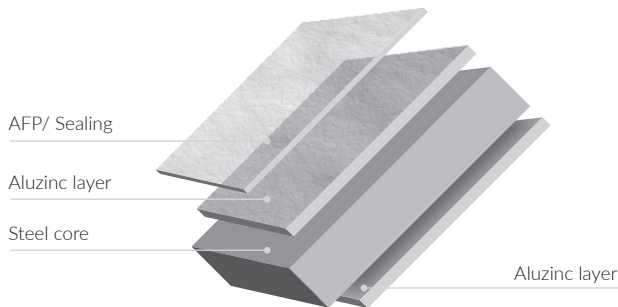

Alucynk AZ185 into the production of roofing! Aluzinc is a sheet covered on both sides with an aluminium and zinc alloy in an electroplating process similar to hot galvanizing process. Thanks to the component proportions of Aluminium 55%, Zinc 43.4% and Silicon 1.6% our products are highly resistant to corrosion thanks to the synergy between the zinc cathodic protection and aluminium screening effect. For manufacturing processes Blachotrapez uses only Aluzinc of 185 g/m² (subject to 25 years of warranty). The sheets meet the requirements of class A1 in accordance with the Commission Decision 96/603/EC on fire protection and may be used in the corrosion category C4 according to the standard EN ISO 12944-2.

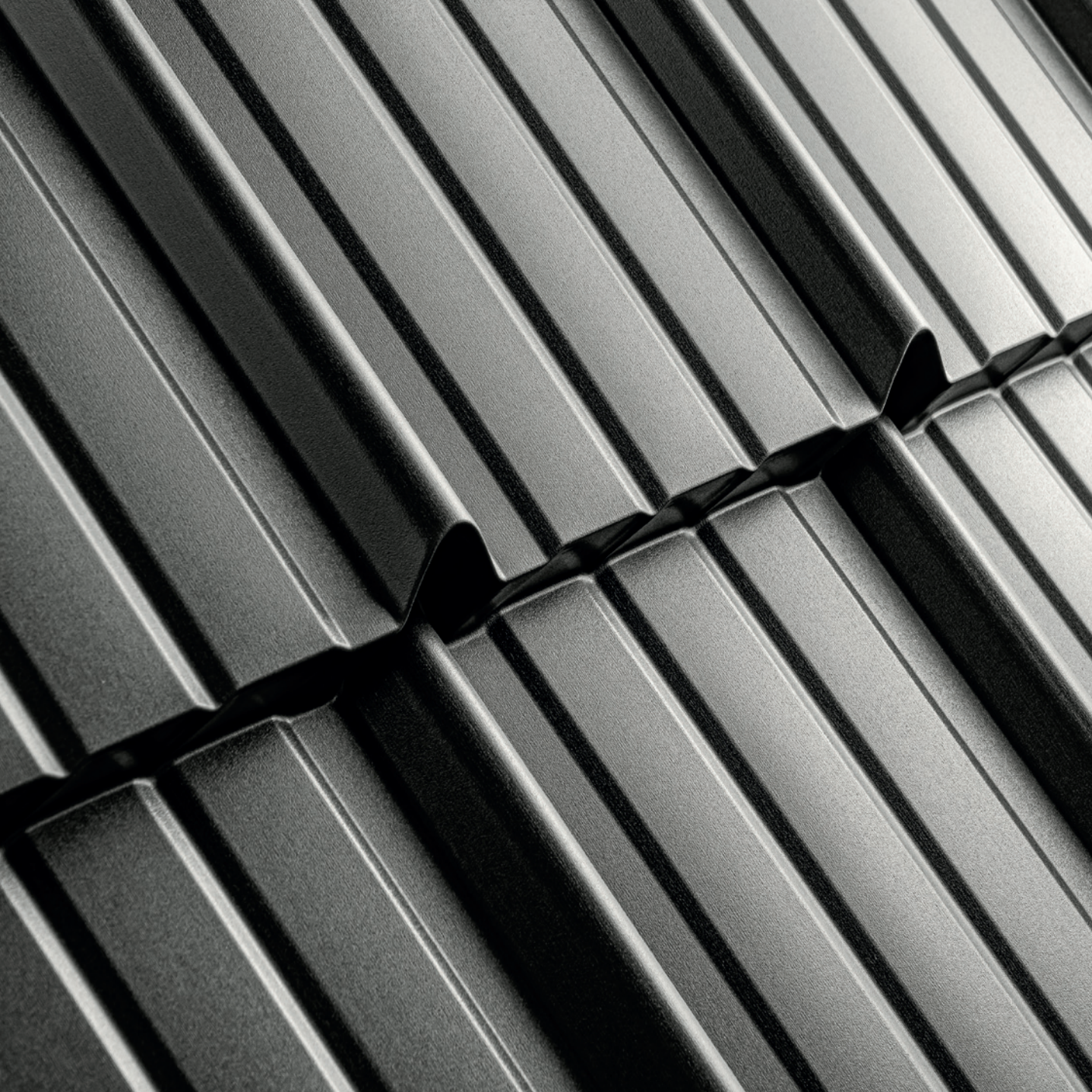



Super Poliester Standard R-MAT

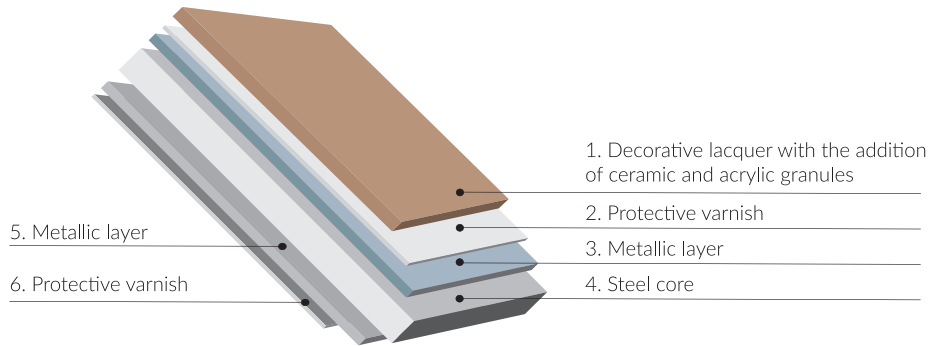

Steel sheets with **Super Poliester Standard R-MAT** coating provide high scratch resistance and UV stability. The applied lacquer is a combination of a thick primer and a super-polyester topcoat, with the addition of ceramic and acrylic granules. This guarantees very-good resistance to external weather conditions.

The **Super Poliester Standard R-MAT** coating has been developed for roofs and facades installed in sunny locations and areas with large annual temperature fluctuations.

The resistance of the **Super Poliester Standard R-MAT** coating to UV rays and aggressive weather conditions ensures high product quality, which will last for years.

The Coated **Super Poliester Standard R-MAT** affords:

- ✓ a semi-matte finish
- ✓ high scratch resistance
- ✓ very-good UV resistance
- ✓ very-good resistance to external weather conditions
- ✓ an ideal choice for both roofs and façades mounted in locations exposed to sunlight and in areas experiencing high annual temperature differences





Hydro

Top layer

Undercoat varnish

Aluminium core

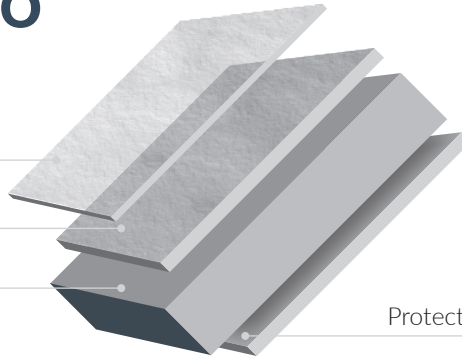

Protective varnish



Aluminium STUCCO
MAT Corase



The material is extremely light at density of only 2.7g/cm^3 . This facilitates designing a lighter building structure, so you can save on construction costs.



The material is 100% renewable and recyclable, which makes it eco-friendly. It does not lose its own original properties during this process.



Heavy duty and durable. The tensile strength of currently produced aluminium alloys is comparable to steel. Aluminium is resistant to harsh weather conditions, making it often a natural choice in many applications.



The plasticity of the material makes it soft and easy to process for a roofer. This feature means that almost any product can be formed from aluminium.



Corrosion-resistant aluminium automatically self-covers with a thin layer of oxygen, rebuilding itself, which prevents further oxidation.



STEEL SERVICE CENTRE (SSC)

The Steel Service Centre (SSC) is intended for customers looking for a material with specific properties and processing level. The processing includes winding, cutting along and across and protection according to the customer's individual needs. We also accept the orders using the customers' materials, which are optimally used within our advanced production processes. The processing services offered by Blachotrapez include the processing of galvanised, Aluzinc and organic-coated steel.

HYDROCONTROL



The water vapour condensation consists in a change of state of water vapour on the surface of uninsulated steel roofing. Such phenomenon depends on many factors, including but not limited to: construction of roofing and its thermal insulation. The water vapour condensation may result in dampening of roof, and thus fungus growth or corrosion. In extreme cases it may result in room flooding or freezing. BLACHOTRAPEZ offers a simple and effective solution for this problem - anti-condensation coating Hydrocontrol. This is a self-adhesive membrane, which is fixed to the back side of the sheet.

SPS

The technological SPS process allows profiling steel material under optimum climatic conditions - independent of the ambient temperature. With its use, input materials can be perfectly plasticised, and this especially goes for paint coatings. Key benefits that SPS technology brings is primarily acquisition of such properties and parameters that increase the durability of the material supplied by our company and the quality of its execution. The applied technology makes the coating material extremely resistant to the destructive effects of external factors, corrosion and damage. Simultaneously, it does not lose its properties, ensuring effective roof protection and high aesthetic values for many years to come. With all these factors resulting from the use of SPS, we have achieved the greatest success - extension of the warranty period for Polyester Standard coating (gloss, matt) by an additional five years for separation of coatings."



Safe
Profiling
System

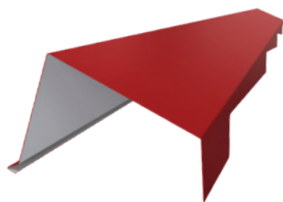

Dedicated to
JANOSIK
metal shingle
MARYNA sprocket



Dedicated to
JANOSIK
metal shingle
Janosik powder skirt

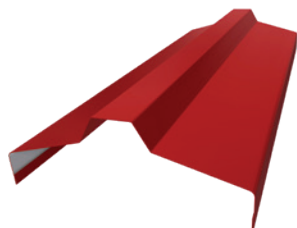

Dedicated to
JANOSIK
metal shingle
GRAN ridge tile



Dedicated to

Powder skirt

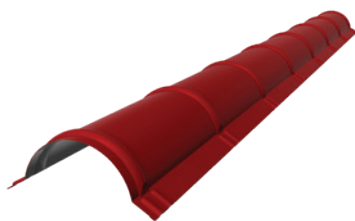

Dedicated to

Ridge tile



Dedicated to

Troughed ridge tile



Dedicated to

Trough ride tile PLUS



TRANSPORT

The ordered material shall be delivered to the place indicated by Customer (it is possible to pick the order up with own transport). Unloading should be performed with professional equipment or, in case of its unavailability, manually by an appropriate number of people. This will enable to avoid scratches, deformations or other accidental damage according to the storage and transport instructions and terms of warranty.

STORAGE

The stored materials should not touch the ground directly. The material should be stored in a dry and ventilated place and kept away from aggressive substances (pesticides, acids). The products secured with protective film should not be exposed to strong sunlight (remember to remove the film immediately). It is also recommended not to store the purchased materials for a period longer than 3 months according to the storage and transport instructions and terms of warranty.

INSTALLATION

For sheet installation we recommend self-tapping screws with EPDM washers (extremely resistance to low and high temperatures). The suggested number of screws used for installation is 5-8 pcs/m². Sheets must be cut with special vibrating shears (Nibler). Do not use any disc-cutters which may cause the lacquer damage! After completing the work remove thoroughly all remains from sheet surface according to the storage and transport instructions and terms of warranty.



www.blachotrapez.eu



thyssenkrupp

Blachotrapez Sp. z o.o.
ul. Kilińskiego 49a
34-700 Rabka-Zdrój



Phone: +48 18 26 85 200
Fax: +48 18 26 85 215
biuro@blachotrapez.eu

1020

This Catalogue does not constitute a commercial offer as defined in the Polish Civil Code.
© Copyright Blachotrapez® | all rights reserved.