

3D's



Project :		24_002 The Green Room - The Thirlmere Lodge Unit 1+2	
Project address :			
Date:	Title :	Rev :	
January 15, 2024	3D	0	



The Green Room
 Unit C Marconi Courtyard
 Brunel Rd, Earlstrees Est.
 Corby,
 Northants
 NN17 4LT

Web: the-green-room.co.uk
 Tel: 01536 358387
 Email: info@the-green-room.co.uk

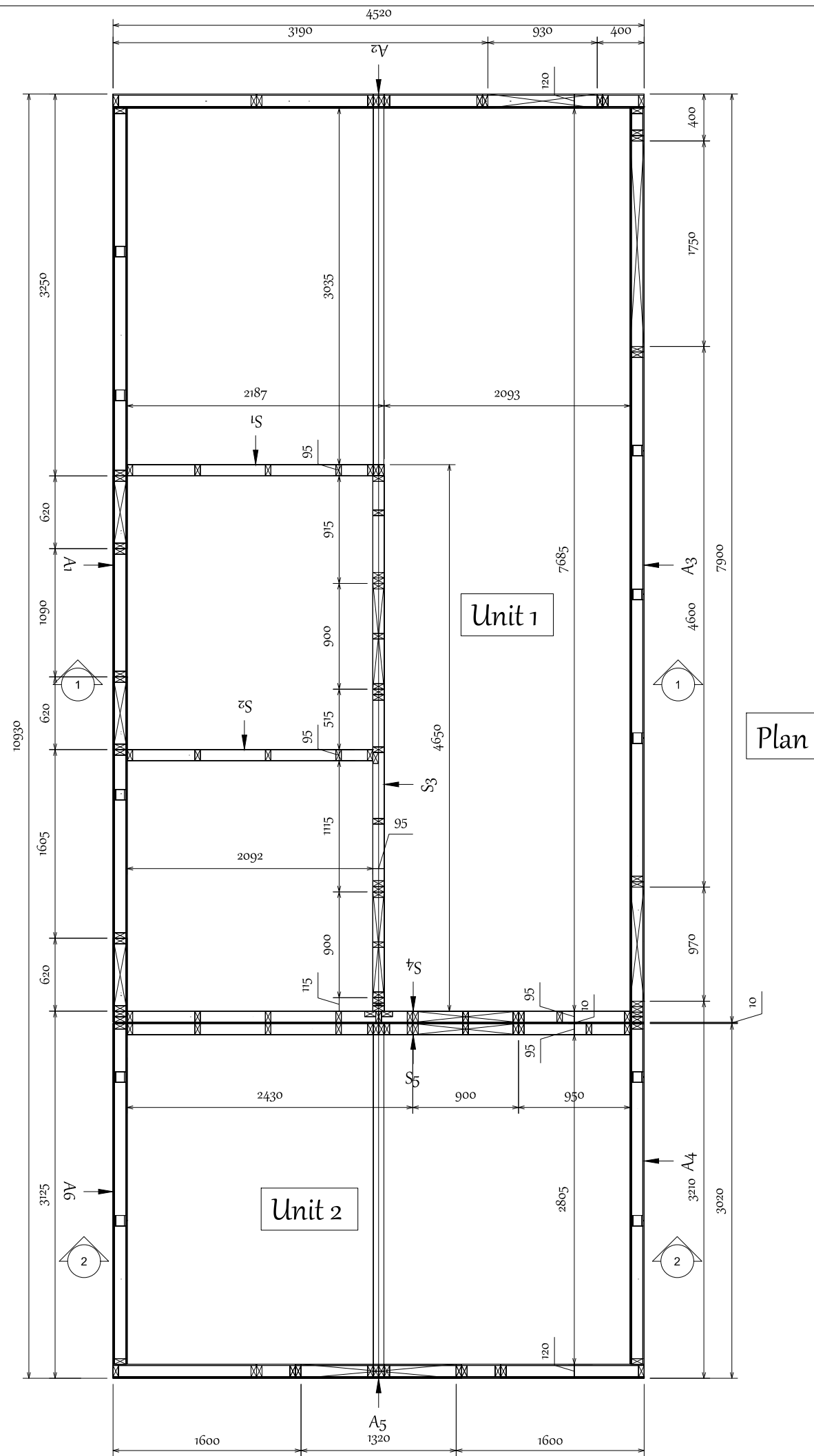

Plan

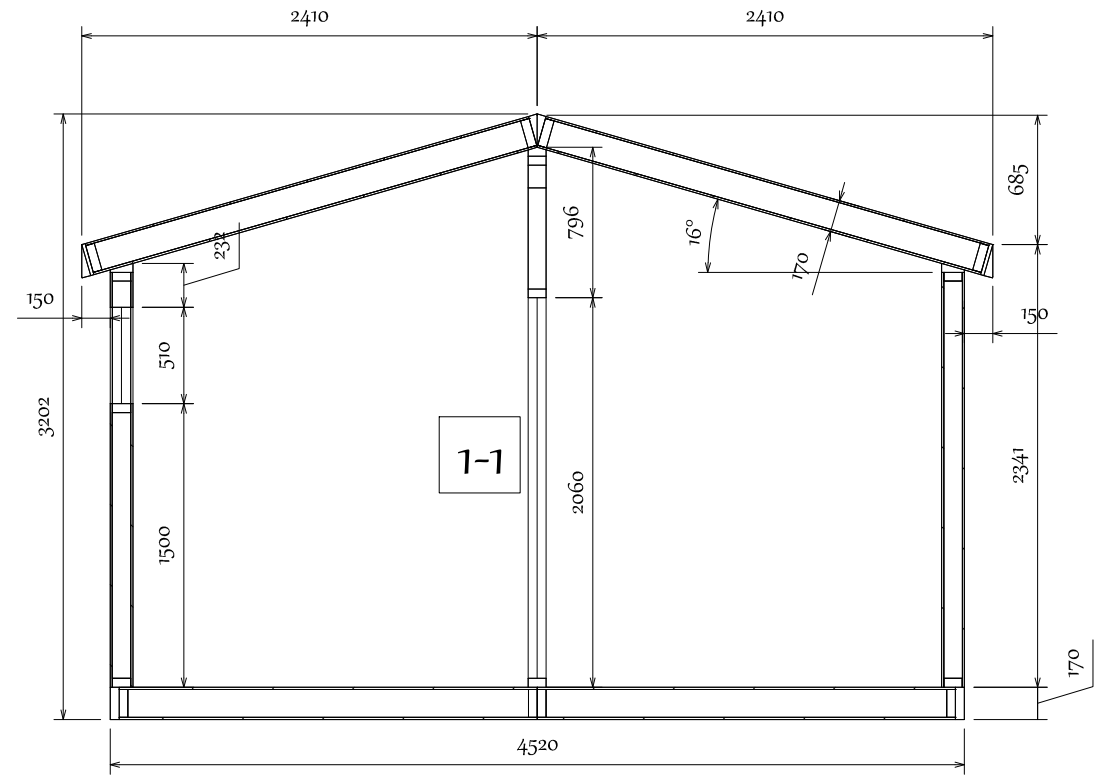

Sections

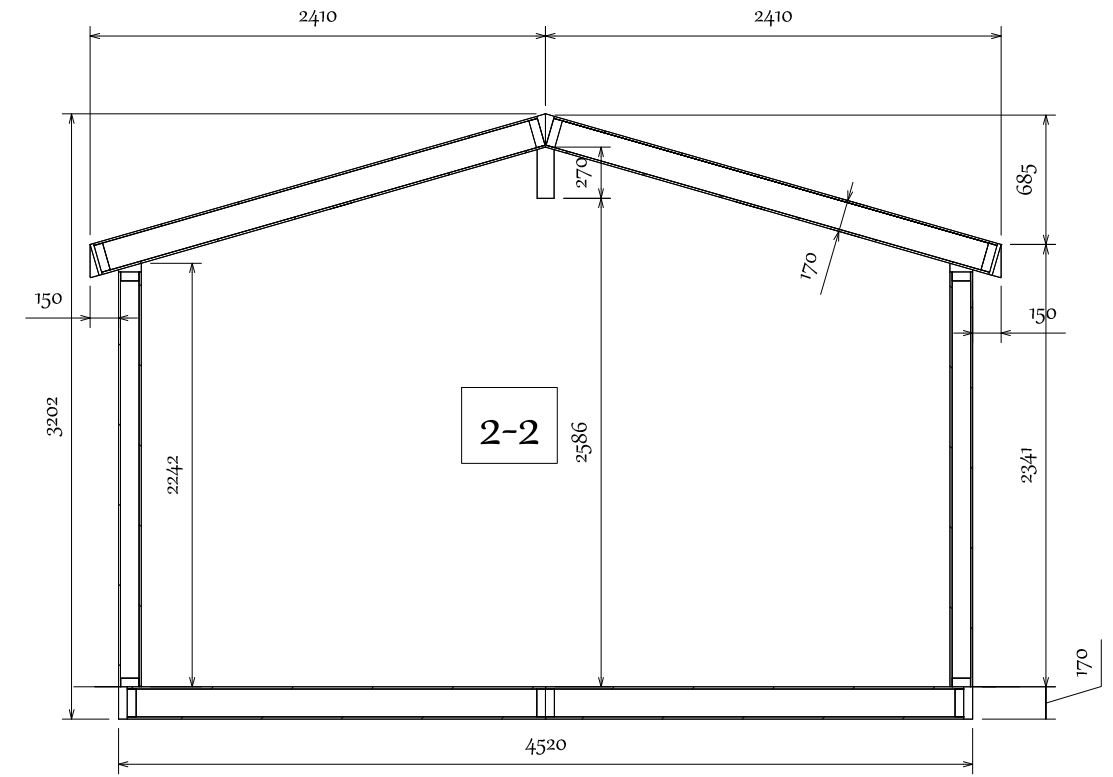

Project : 24_002 The Green Room - The Thirlmere Lodge Unit 1+2			The Green Room Unit C Marconi Courtyard Brunel Rd, Earlstrees Est.	
Project address :			Corby, Northants NN17 4LT	
Date: January 15, 2024	Title: Plan, Sections	Rev: 0	Web: the-green-room.co.uk Tel: 01536 358387 Email: info@the-green-room.co.uk	

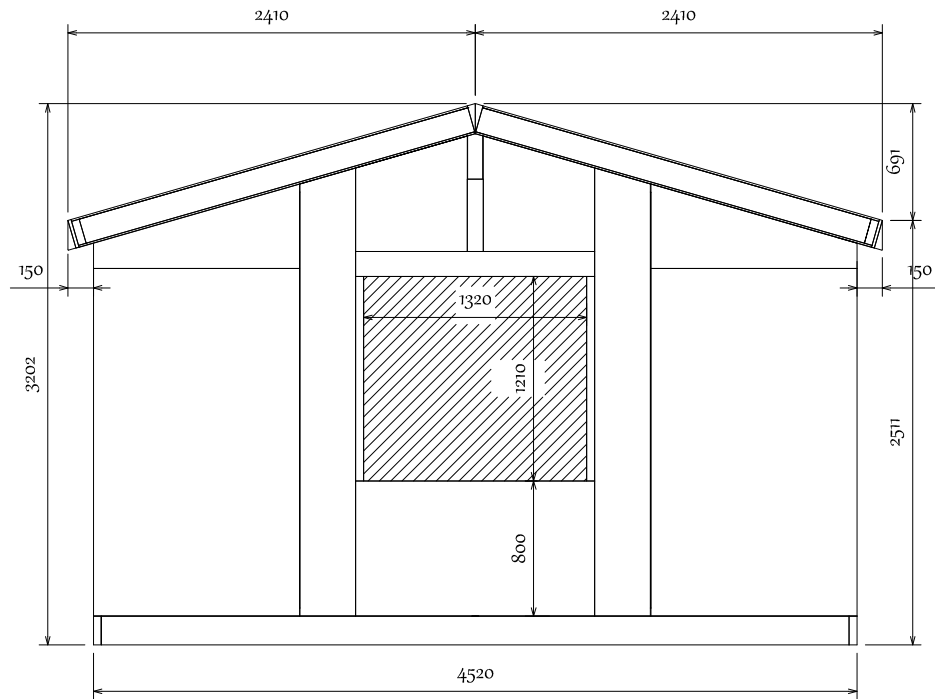

Bottom

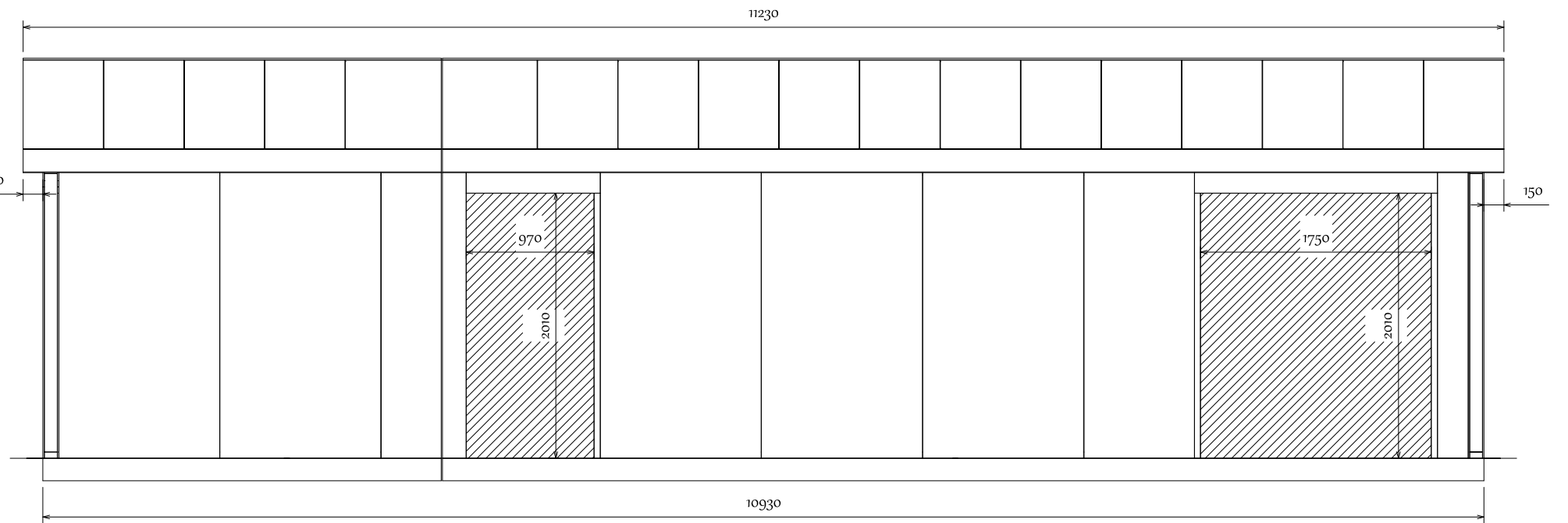

Right

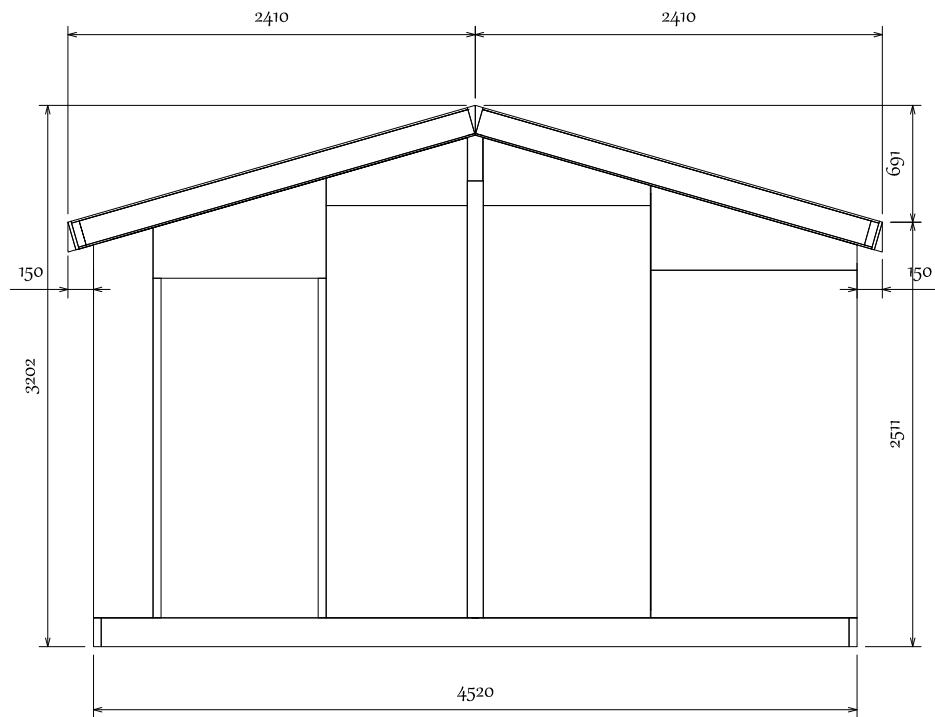

Top

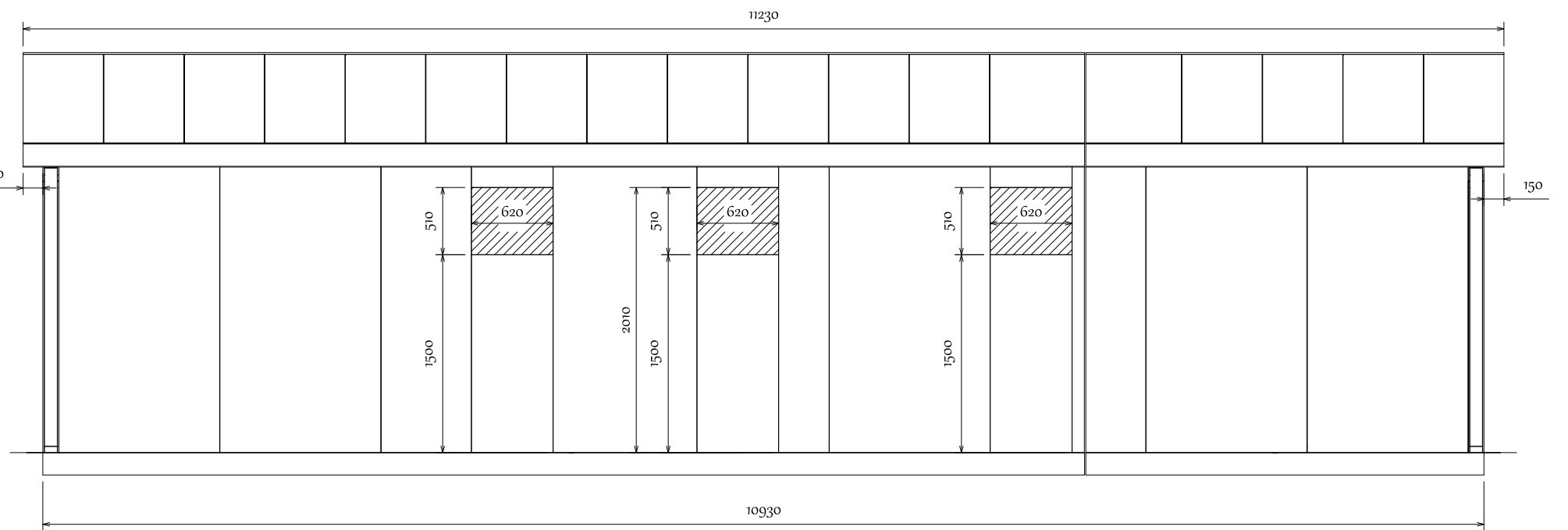

Left

Project : 24_002 The Green Room - The Thirlmere Lodge Unit 1+2				The Green Room Unit C Marconi Courtyard Brunel Rd, Earlstrees Est. Corby, Northants NN17 4LT	Web: the-green-room.co.uk Tel: 01536 358387 Email: info@the-green-room.co.uk
Project address :					
Date: January 15, 2024	Title: Elevations	Rev: 0			

Diagonal: 9038

Prefabricated Cuts				
End stud				
Nr.	Dimension	Length	Angle	Amount
1	47 x 170	4426	90>90 - 90>90	1
102	47 x 170	7900	90>90 - 90>90	2
3	47 x 147	4332	90>90 - 90>90	2
6	47 x 147	7853	90>90 - 90>90	2

Lumber				
Nr.	Dimension	Length	Angle	Amount
20	47 x 147	423	90>90 - 90>90	2
4	47 x 147	1128	90>90 - 90>90	2
8	47 x 147	1129	90>90 - 90>90	10
2	47 x 147	4332	90>90 - 90>90	12

Sip Panels			
SIP170 Label	Width	Length	Thickness
F1 - 1	1220	2212	170
F1 - 10	1220	2212	170
F1 - 11	1220	2212	170
F1 - 12	1220	2212	170
F1 - 13	515	2212	170
F1 - 14	515	2212	170
F1 - 2	1220	2212	170
F1 - 3	1220	2212	170
F1 - 4	1220	2212	170
F1 - 5	1220	2212	170
F1 - 6	1220	2212	170
F1 - 7	1220	2212	170
F1 - 8	1220	2212	170
F1 - 9	1220	2212	170

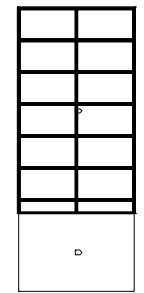
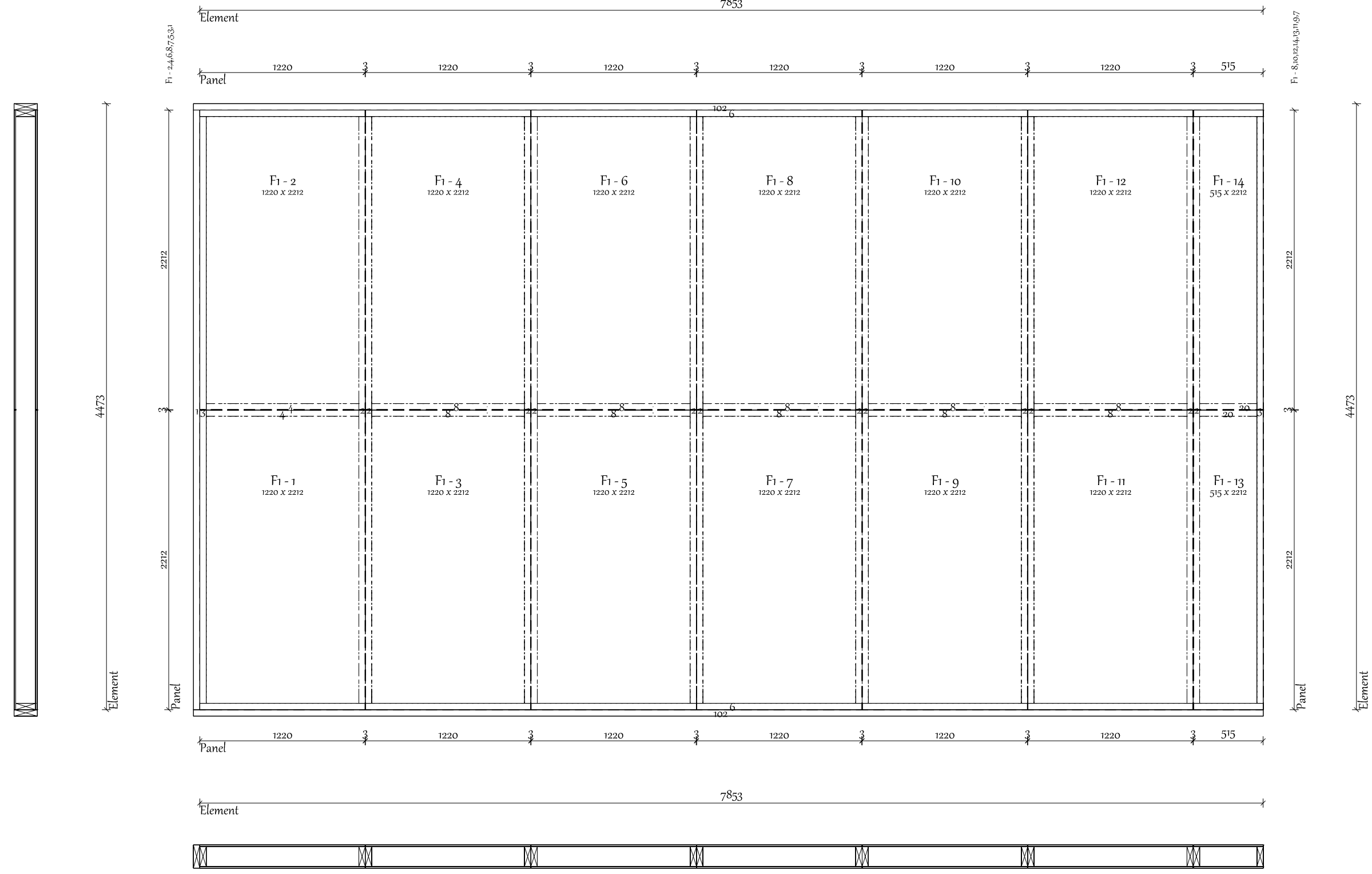

Client:	24_002 The Green Room - The Thirlmere Lodge Unit 1+2	Project number:		Weight:	575kg
Site Address:		Drawn By:		Panel No:	F1
Title:		W/O:			
		Date:	15/01/2024		



Diagonal: 5397

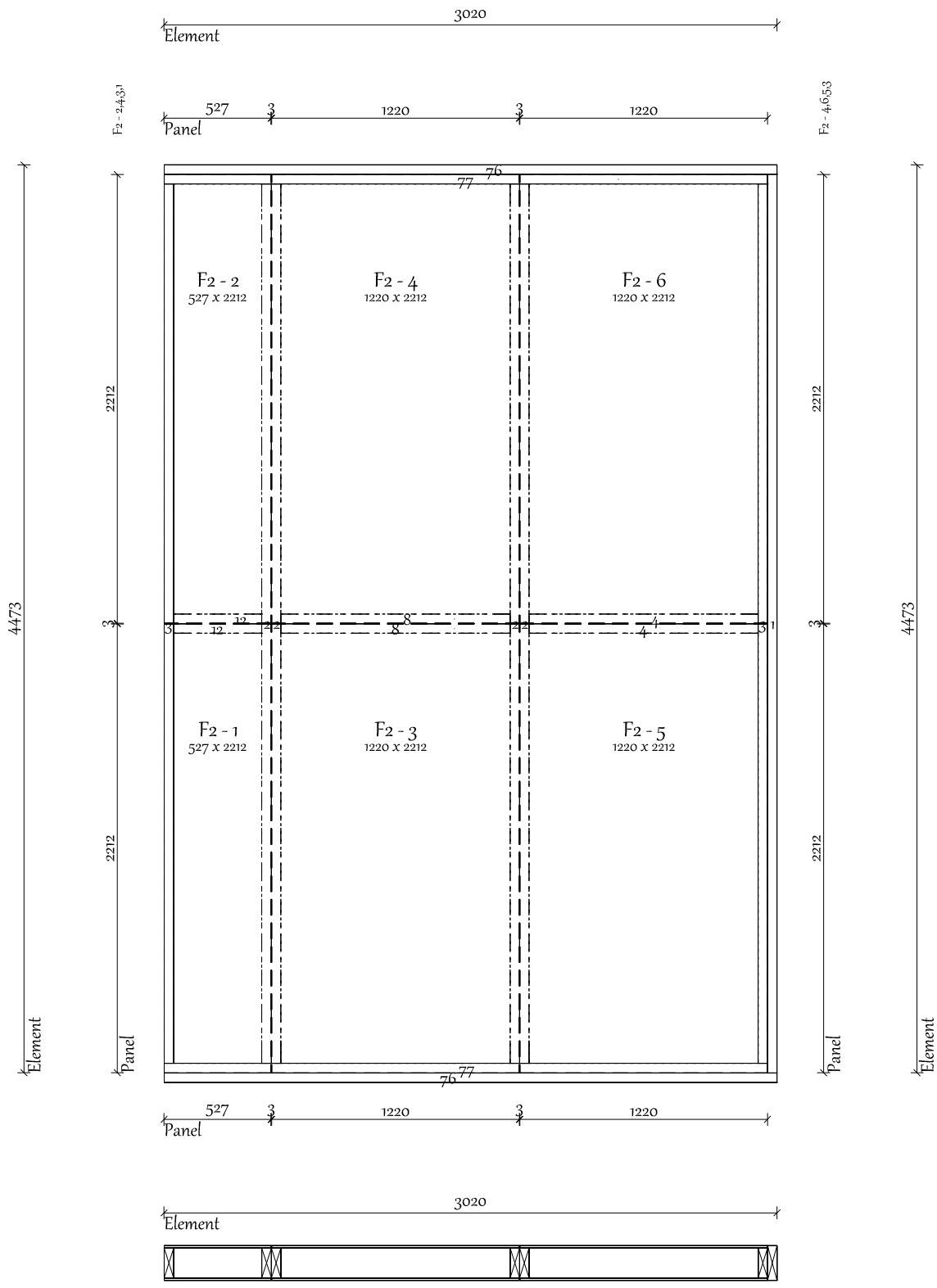
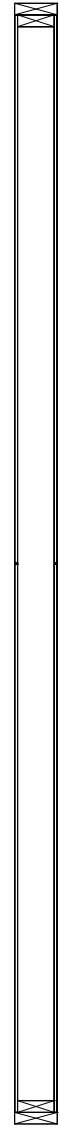

Prefabricated Cuts				
End stud				
Nr.	Dimension	Length	Angle	Amount
76	47 x 170	3020	90>90 - 90>90	2
1	47 x 170	4426	90>90 - 90>90	1
77	47 x 147	2973	90>90 - 90>90	2
3	47 x 147	4332	90>90 - 90>90	2
Lumber				
Nr.	Dimension	Length	Angle	Amount
12	47 x 147	435	90>90 - 90>90	2
4	47 x 147	1128	90>90 - 90>90	2
8	47 x 147	1129	90>90 - 90>90	2
2	47 x 147	4332	90>90 - 90>90	4
Sip Panels				
SIP170				
Label	Width	Length	Thickness	
F2 - 1	527	2212	170	
F2 - 2	527	2212	170	
F2 - 3	1220	2212	170	
F2 - 4	1220	2212	170	
F2 - 5	1220	2212	170	
F2 - 6	1220	2212	170	

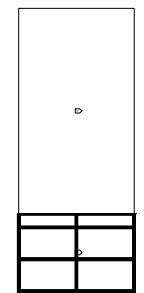

Client:	24_002 The Green Room - The Thirlmere Lodge Unit 1+2	Project number:		Weight:	563kg
Site Address:		Drawn By:		Panel No:	F2
		W/O:			
Title:		Date:	15/01/2024		



Diagonal: 8096

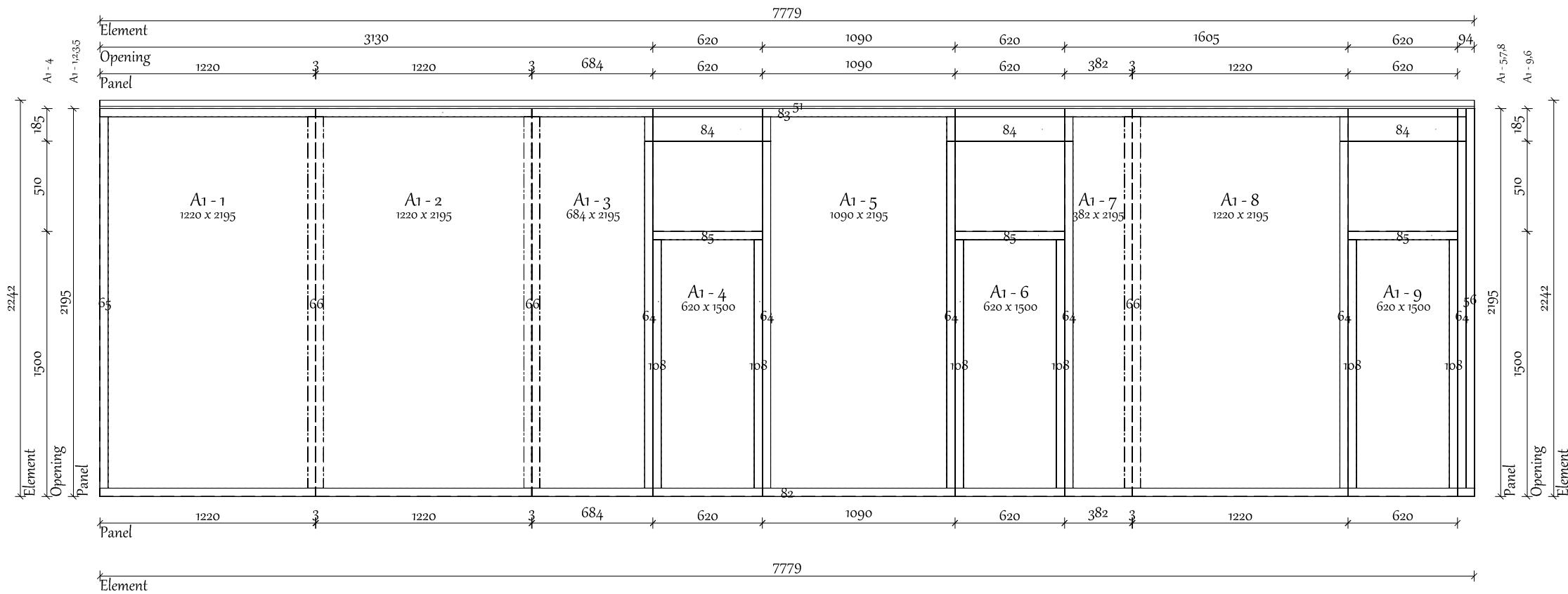

Prefabricated Cuts				
Bottom plate				
Nr.	Dimension	Length	Angle	Amount
82	97 x 47	7779	90>90 - 90>90	1
End stud				
Nr.	Dimension	Length	Angle	Amount
65	97 x 47	2101	90>90 - 90>90	1
Top plate				
Nr.	Dimension	Length	Angle	Amount
83	97 x 47	7732	90>90 - 90>90	1
Cill plate				
Nr.	Dimension	Length	Angle	Amount
85	97 x 47	620	90>90 - 90>90	3
Post				
Nr.	Dimension	Length	Angle	Amount
108	47 x 97	1406	90>90 - 90>90	6
64	47 x 97	1963	90>90 - 90>90	6
56	47 x 97	2148	90>90 - 90>90	1
Spline				
Nr.	Dimension	Length	Angle	Amount
66	90 x 95	2101	90>90 - 90>90	3
Furring				
Nr.	Dimension	Length	Angle	Amount
51	120 x 47	7779	90>90 - 90>90	1
Generic				
Nr.	Dimension	Length	Angle	Amount
84	97 x 138	714	90>90 - 90>90	3
Sip Panels				
SIP120				
Label	Width	Length	Thickness	
A1 - 1	1220	2195	120	
A1 - 2	1220	2195	120	
A1 - 3	684	2195	120	
A1 - 4	620	1500	120	
A1 - 5	1090	2195	120	
A1 - 6	620	1500	120	
A1 - 7	382	2195	120	
A1 - 8	1220	2195	120	
A1 - 9	620	1500	120	
Wallboard				
OSB				
Nr.	Dimension	Thickness	Amount	
16	620 x 185	11	6	
13	2195 x 94	11	2	

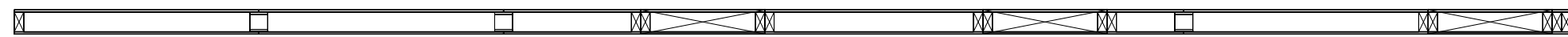
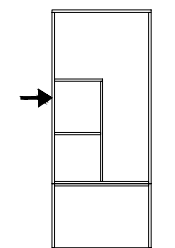
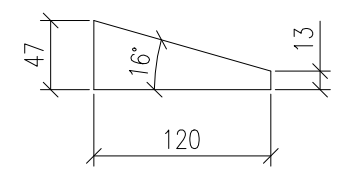

Client:	24_002 The Green Room - The Thirlmere Lodge Unit 1	Project number:		Weight:	233kg
Site Address:		Drawn By:		Panel No:	A1
Title:		W/O:			
		Date:	15/01/2024		



Diagonal: 5339

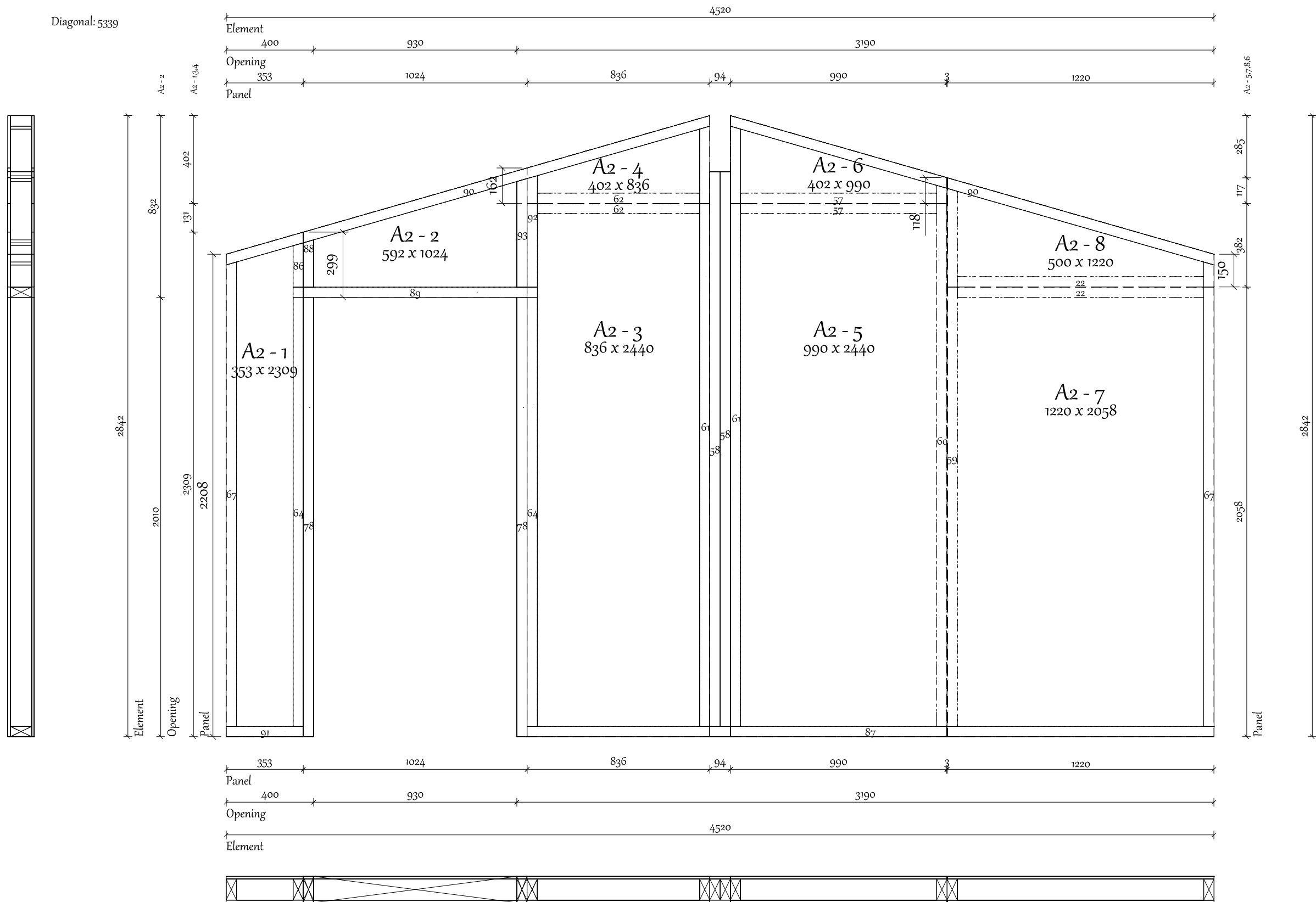

Prefabricated Cuts				
Bottom plate				
Nr.	Dimension	Length	Angle	Amount
91	97 x 47	353	90>90 - 90>90	1
87	97 x 47	3143	90>90 - 90>90	1
End stud				
Nr.	Dimension	Length	Angle	Amount
58	47 x 97	2539	90>90 - 90>90	2
61	47 x 97	2746	90>74 - 90>90	2
67	97 x 47	2125	-74>90 - 90>90	2
Top plate				
Nr.	Dimension	Length	Angle	Amount
90	97 x 47	2316	-74>90 - -74>90	2
Post				
Nr.	Dimension	Length	Angle	Amount
88	47 x 97	216	90>90 - 90>-74	1
93	47 x 97	497	90>90 - 90>-74	1
64	47 x 97	1963	90>90 - 90>90	2
78	47 x 120	2010	90>90 - 90>90	2
Stub post				
Nr.	Dimension	Length	Angle	Amount
86	47 x 97	203	90>90 - 90>74	1
92	47 x 97	510	90>90 - 90>74	1
Lumber				
Nr.	Dimension	Length	Angle	Amount
62	47 x 97	742	90>90 - 90>90	2
57	47 x 97	898	90>90 - 90>90	2
22	47 x 97	1128	90>90 - 90>90	2
59	47 x 97	2462	90>90 - 90>-74	1
60	47 x 97	2475	90>90 - 90>-74	1
Generic				
Nr.	Dimension	Length	Angle	Amount
89	97 x 47	1118	90>90 - 90>90	1
Sip Panels				
SIP120	Label	Width	Length	Thickness
	A2 - 1	353	2309	120
	A2 - 2	1024	592	120
	A2 - 3	836	2440	120
	A2 - 4	836	402	120
	A2 - 5	990	2440	120
	A2 - 6	990	402	120
	A2 - 7	1220	2058	120
	A2 - 8	1220	500	120
Wallboard				
OSB				
Nr.	Dimension	Thickness	Amount	
33	94 x 2586	11	2	

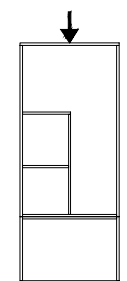

Client:	24_002 The Green Room - The Thirlmere Lodge Unit 1	Project number:		Weight:	132kg
Site Address:		Drawn By:		Panel No:	A2
Title:		W/O:			
		Date:	15/01/2024		



Diagonal: 8097

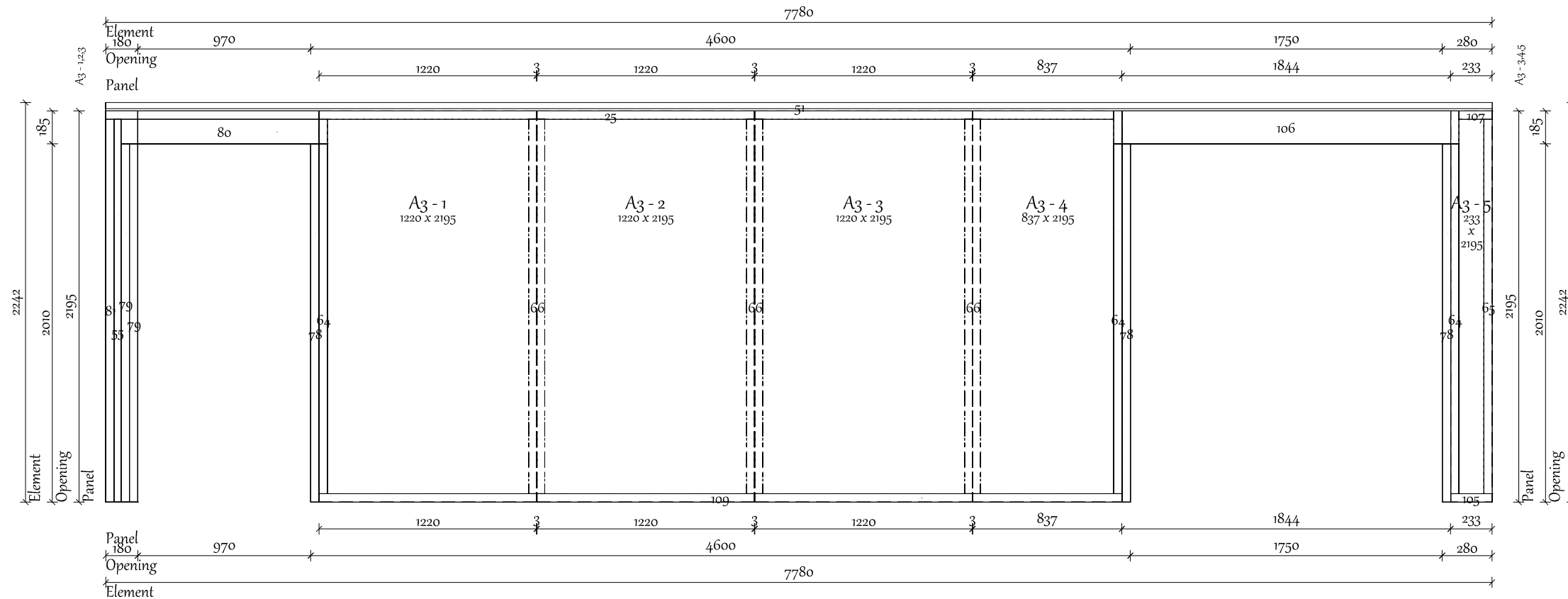

Prefabricated Cuts				
End stud				
Nr.	Dimension	Length	Angle	Amount
65	97 x 47	2101	90>90 - 90>90	1
81	97 x 47	2148	90>90 - 90>90	1
Top plate				
Nr.	Dimension	Length	Angle	Amount
107	97 x 47	186	90>90 - 90>90	1
25	97 x 47	5656	90>90 - 90>90	1
Post				
Nr.	Dimension	Length	Angle	Amount
64	47 x 97	1963	90>90 - 90>90	3
79	47 x 97	2010	90>90 - 90>90	2
55	39 x 97	2148	90>90 - 90>90	1
78	47 x 120	2010	90>90 - 90>90	3
Bottom plate				
Nr.	Dimension	Length	Angle	Amount
105	97 x 47	233	90>90 - 90>90	1
109	97 x 47	4506	90>90 - 90>90	1
Spline				
Nr.	Dimension	Length	Angle	Amount
66	90 x 95	2101	90>90 - 90>90	3
Furring				
Nr.	Dimension	Length	Angle	Amount
51	120 x 47	7780	90>90 - 90>90	1
Generic				
Nr.	Dimension	Length	Angle	Amount
106	97 x 185	1938	90>90 - 90>90	1
80	97 x 138	1158	90>90 - 90>90	1
Sip Panels				
SIP120				
Label	Width	Length	Thickness	
A3 - 1	1220	2195	120	
A3 - 2	1220	2195	120	
A3 - 3	1220	2195	120	
A3 - 4	837	2195	120	
A3 - 5	233	2195	120	
Wallboard				
OSB				
Nr.	Dimension	Thickness	Amount	
11	180 x 2195	11	2	
19	185 x 1017	11	2	
5	185 x 1844	11	2	

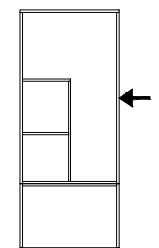
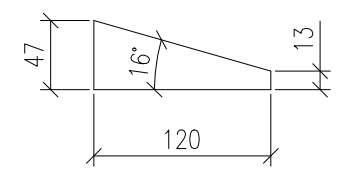

Client:	24_002 The Green Room - The Thirlmere Lodge Unit 1	Project number:		Weight:	184kg
Site Address:		Drawn By:		Panel No:	A3
		W/O:			
Title:		Date:	15/01/2024		



Diagonal: 3666

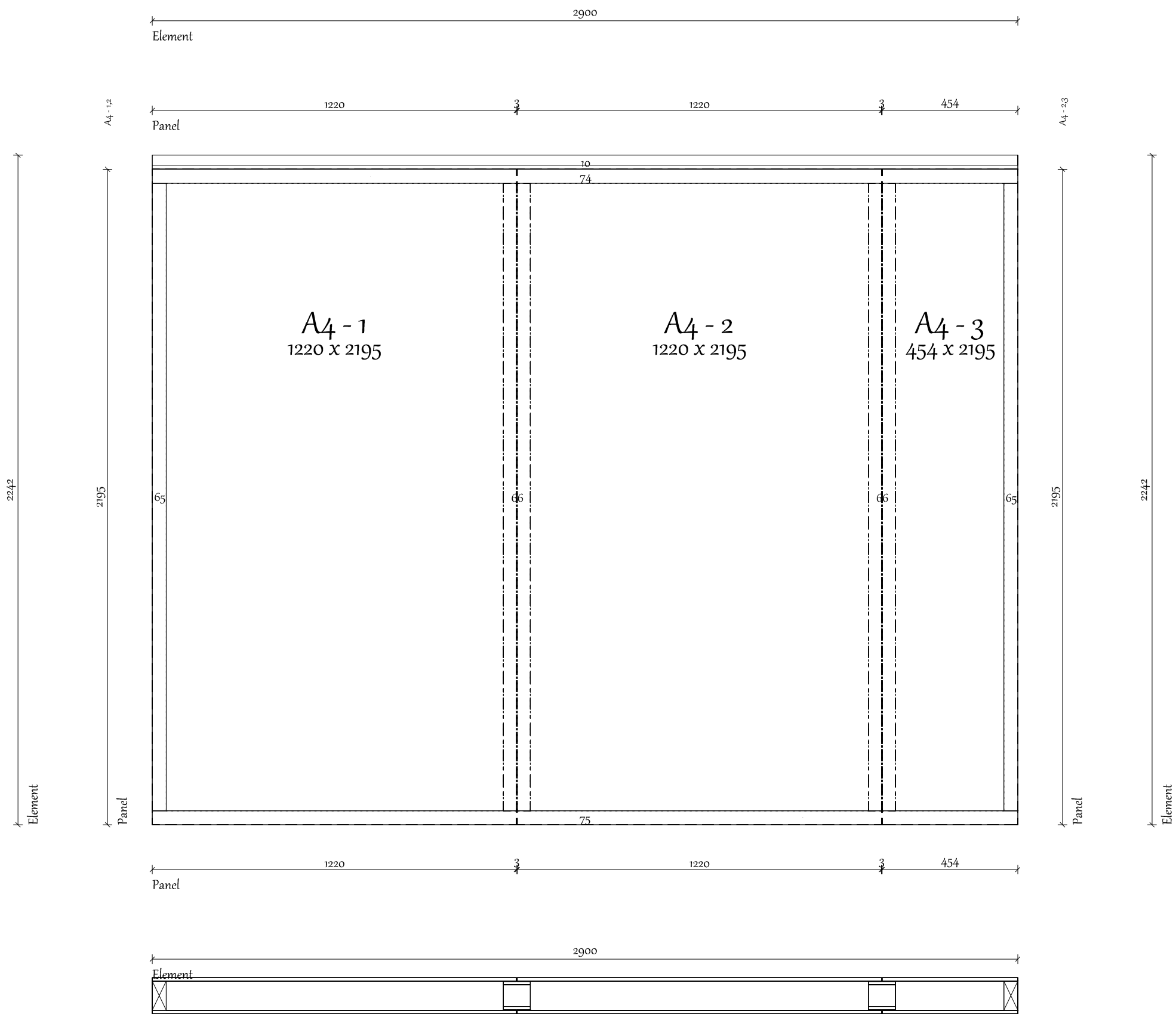
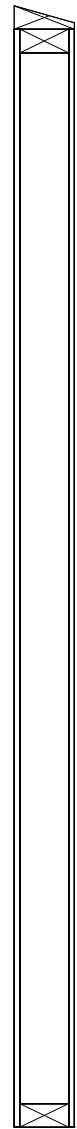

Prefabricated Cuts

Bottom plate				
Nr.	Dimension	Length	Angle	Amount
75	97 x 47	2900	90>90 - 90>90	1
End stud				
Nr.	Dimension	Length	Angle	Amount
65	97 x 47	2101	90>90 - 90>90	2
Top plate				
Nr.	Dimension	Length	Angle	Amount
74	97 x 47	2900	90>90 - 90>90	1
Spline				
Nr.	Dimension	Length	Angle	Amount
66	90 x 95	2101	90>90 - 90>90	2
Furring				
Nr.	Dimension	Length	Angle	Amount
10	120 x 47	2900	90>90 - 90>90	1
Sip Panels				
SIP120 Label	Width	Length	Thickness	
A4 - 1	1220	2195	120	
A4 - 2	1220	2195	120	
A4 - 3	454	2195	120	

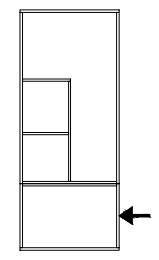
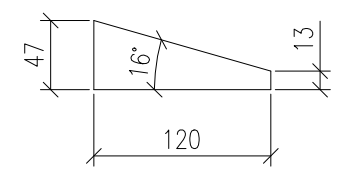

Client:	24_002 The Green Room - The Thirlmere Lodge Unit 1	Project number:		Weight:	120kg
Site Address:		Drawn By:		Panel No:	A4
Title:		W/O:			
		Date:	15/01/2024		



Diagonal: 5339

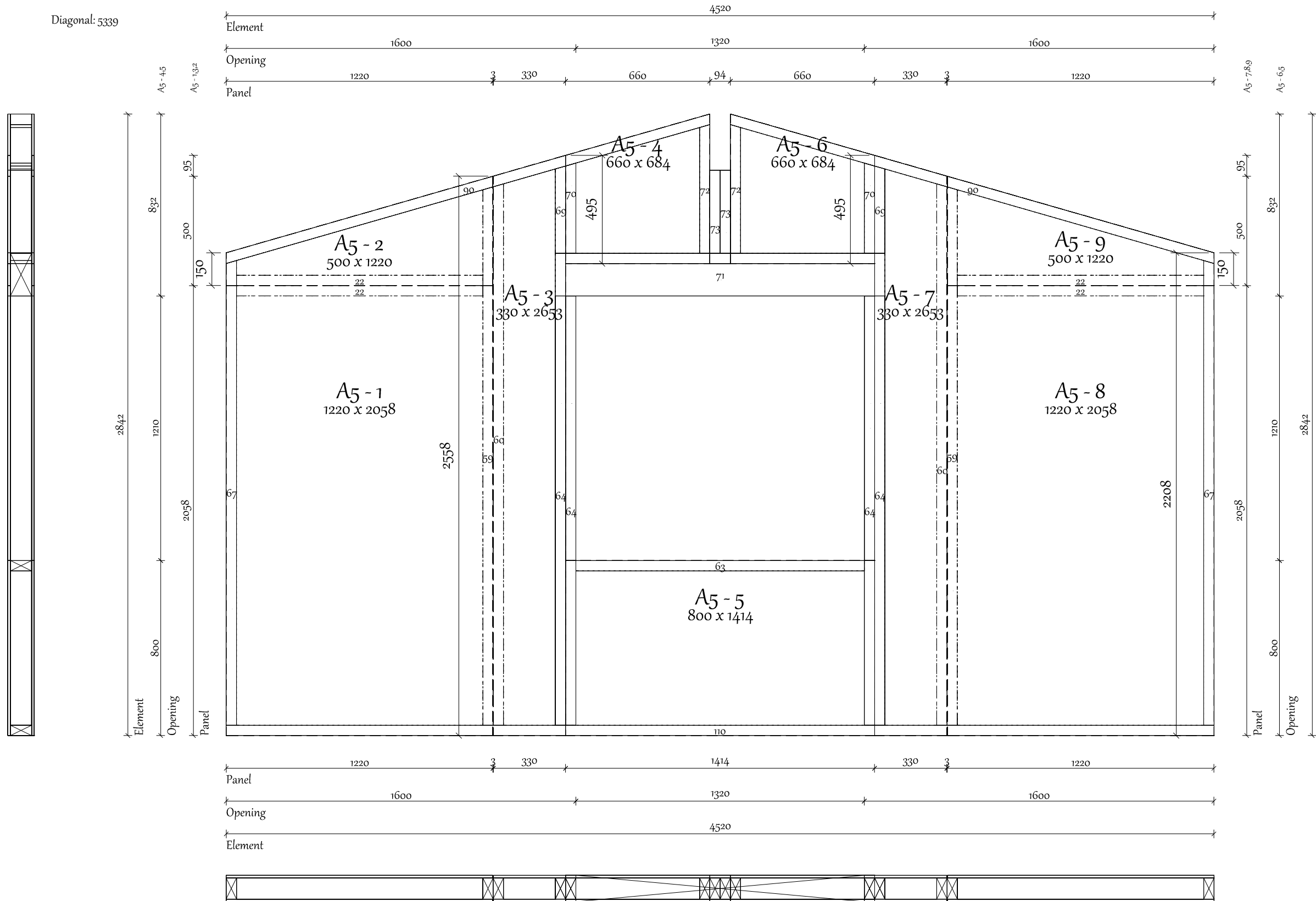

Prefabricated Cuts				
Nr.	Dimension	Length	Angle	Amount
Bottom plate				
97	97 x 47	4520	90>90 - 90>90	1
End stud				
73	47 x 97	381	90>90 - 90>90	2
72	47 x 97	588	90>-74 - 90>90	2
67	97 x 47	2125	-74>90 - 90>90	2
Top plate				
90	97 x 47	2316	-74>90 - -74>90	2
Double 195				
71	97 x 195	1508	90>90 - 90>90	1
Cill plate				
63	97 x 47	1320	90>90 - 90>90	1
Lumber				
22	47 x 97	1128	90>90 - 90>90	4
59	47 x 97	2462	90>-74 - 90>90	2
60	47 x 97	2475	90>-74 - 90>90	2
Post				
70	47 x 97	412	90>90 - 90>-74	2
64	47 x 97	1963	90>90 - 90>90	4
Stub post				
69	47 x 97	399	90>90 - 90>74	2
Sip Panels				
SIP120				
Label	Width	Length	Thickness	
A5 - 1	1220	2058	120	
A5 - 2	1220	500	120	
A5 - 3	330	2653	120	
A5 - 4	660	684	120	
A5 - 5	1414	800	120	
A5 - 6	660	684	120	
A5 - 7	330	2653	120	
A5 - 8	1220	2058	120	
A5 - 9	1220	500	120	
Wallboard				
OSB				
Nr.	Dimension	Thickness	Amount	
68	428 x 94	11	2	
9	1414 x 148	11	2	
7	1210 x 47	11	4	

Client:	24_002 The Green Room - The Thirlmere Lodge Unit 1	Project number:		Weight:	151kg
Site Address:		Drawn By:		Panel No:	A5
		W/O:			
Title:		Date:	15/01/2024		

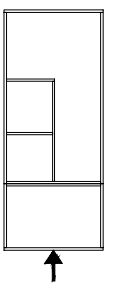

Diagonal: 3666

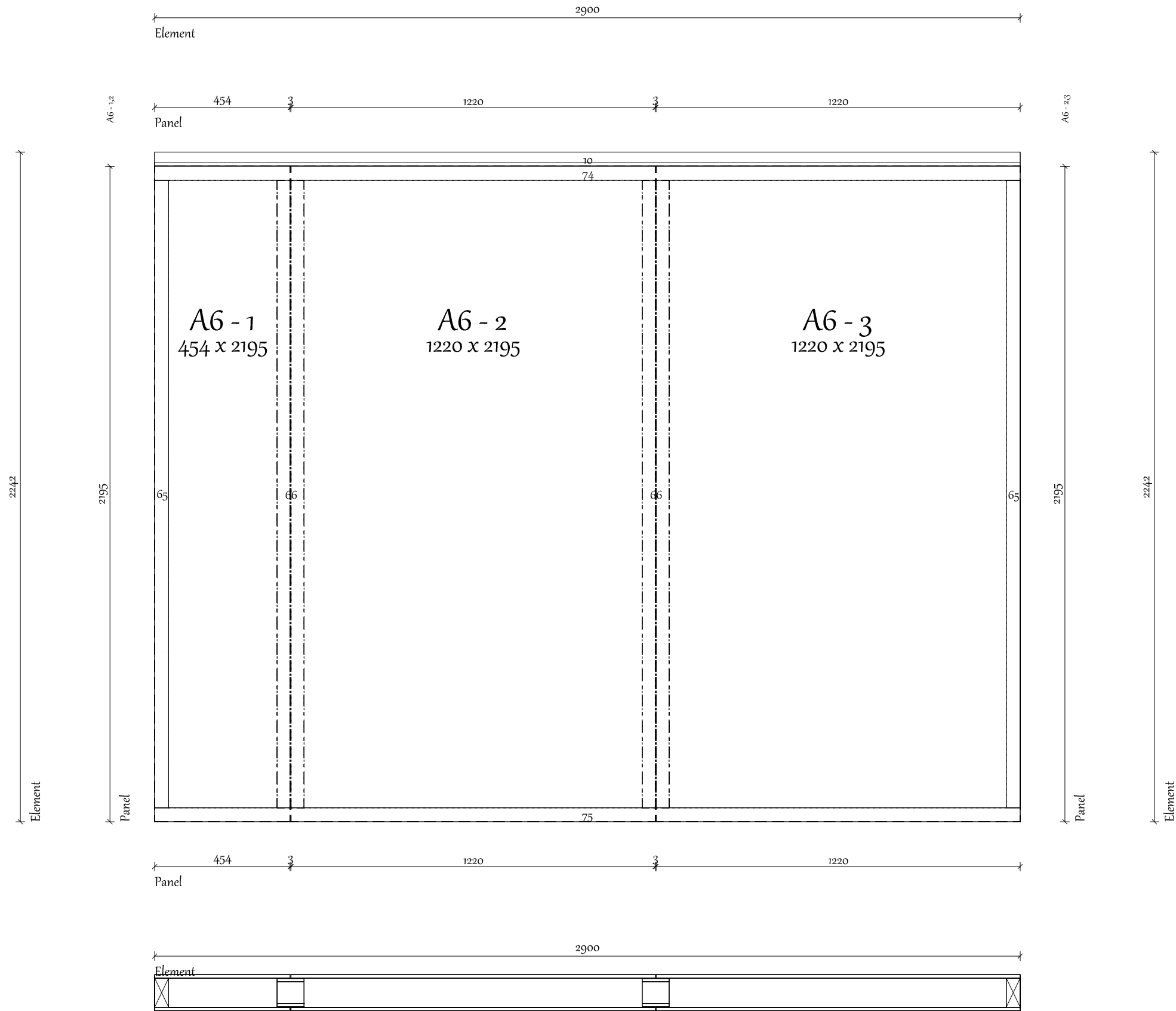
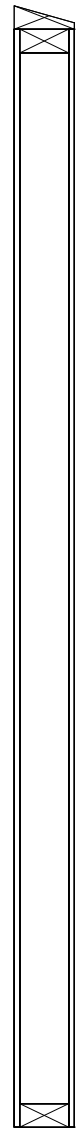

Prefabricated Cuts				
Bottom plate				
Nr.	Dimension	Length	Angle	Amount
75	97 x 47	2900	90>90 - 90>90	1
End stud				
Nr.	Dimension	Length	Angle	Amount
65	97 x 47	2101	90>90 - 90>90	2
Top plate				
Nr.	Dimension	Length	Angle	Amount
74	97 x 47	2900	90>90 - 90>90	1
Spline				
Nr.	Dimension	Length	Angle	Amount
66	90 x 95	2101	90>90 - 90>90	2
Furring				
Nr.	Dimension	Length	Angle	Amount
10	120 x 47	2900	90>90 - 90>90	1
Sip Panels				
SIP120 Label	Width	Length	Thickness	
A6 - 1	454	2195	120	
A6 - 2	1220	2195	120	
A6 - 3	1220	2195	120	

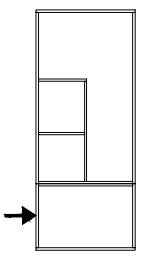
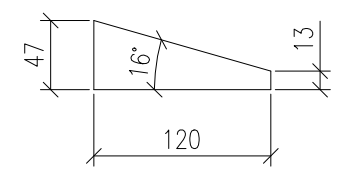

Client:	24_002 The Green Room - The Thirlmere Lodge Unit 1	Project number:		Weight:	291kg
Site Address:		Drawn By:		Panel No:	A6
Title:		W/O:			
		Date:	15/01/2024		



Internal 47x95 47x95

Diagonal: 3530

Prefabricated Cuts				
Bottom plate				
Nr.	Dimension	Length	Angle	Amount
23	47 x 95	2187	90>90 - 90>90	1
Top plate				
Nr.	Dimension	Length	Angle	Amount
54	47 x 95	2191	90>74 - 90>74	1
Stud				
Nr.	Dimension	Length	Angle	Amount
18	47 x 95	2160	90>90 - 90>-74	1
40	47 x 95	2325	90>90 - 90>-74	1
45	47 x 95	2497	90>90 - 90>-74	1
32	47 x 95	2539	90>90 - 90>90	2
44	47 x 95	2669	90>90 - 90>-74	1
31	47 x 95	2746	90>90 - 90>-74	1

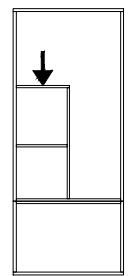
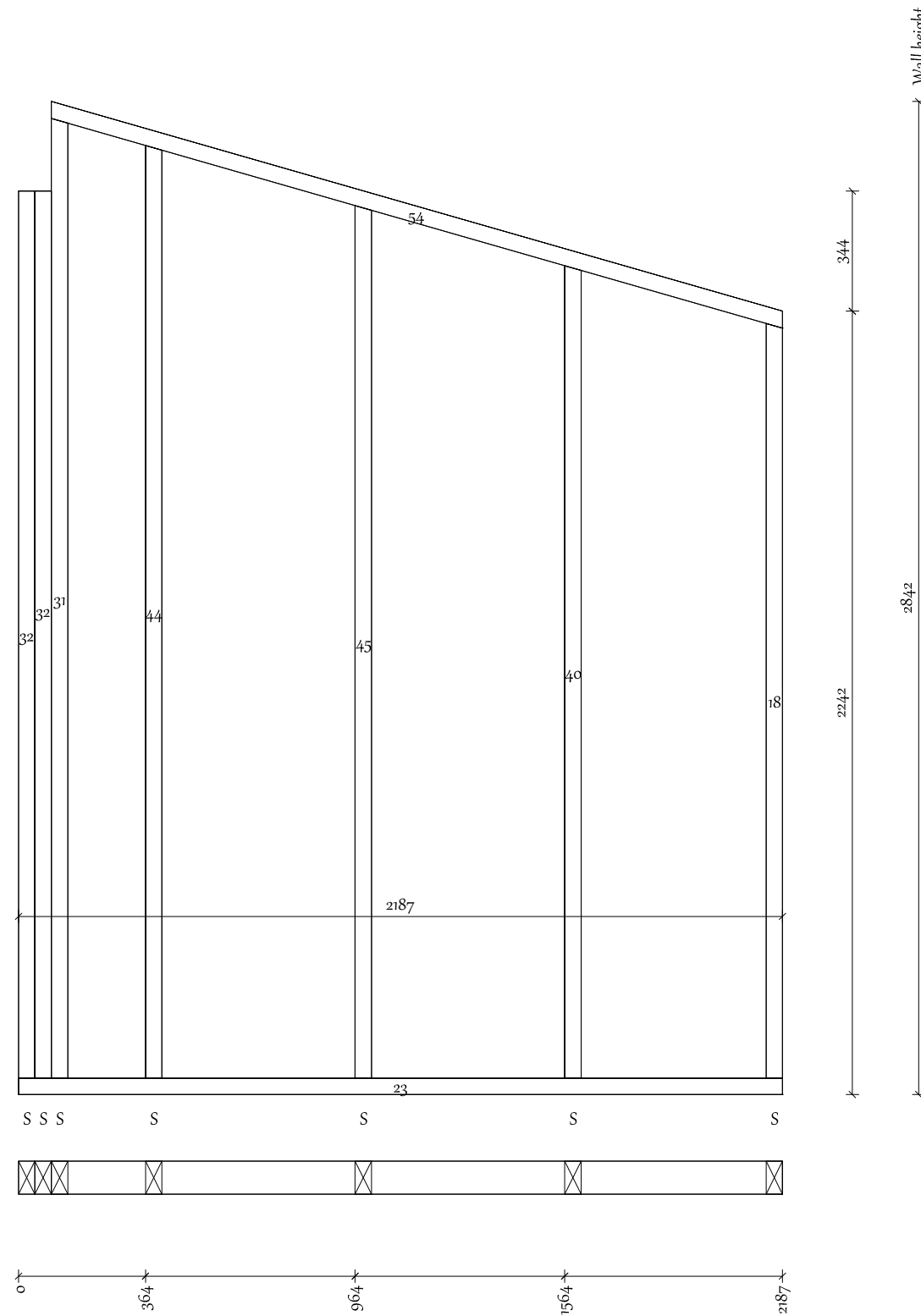
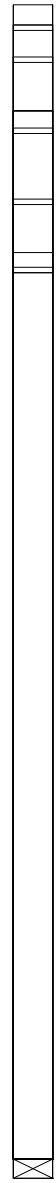

Client:	24_002 The Green Room - The Thirlmere Lodge Unit 142	Project number:		Weight:	54kg
Site Address:		Drawn By:		Multiwall No.:	
		W/O:		Panel No.:	S1
Title:		Date:	15/01/2024	Nailing Spec:	



Internal 47x95 47x95

Diagonal: 3529

Prefabricated Cuts				
Bottom plate				
Nr.	Dimension	Length	Angle	Amount
17	47 x 95	2092	90>90 - 90>90	1
Top plate				
Nr.	Dimension	Length	Angle	Amount
49	47 x 95	2190	90>74 - 90>74	1
Stud				
Nr.	Dimension	Length	Angle	Amount
18	47 x 95	2160	90>90 - 90>-74	1
40	47 x 95	2325	90>90 - 90>-74	1
45	47 x 95	2497	90>90 - 90>-74	1
44	47 x 95	2669	90>90 - 90>-74	1
31	47 x 95	2746	90>90 - 90>-74	1

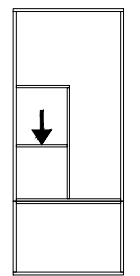
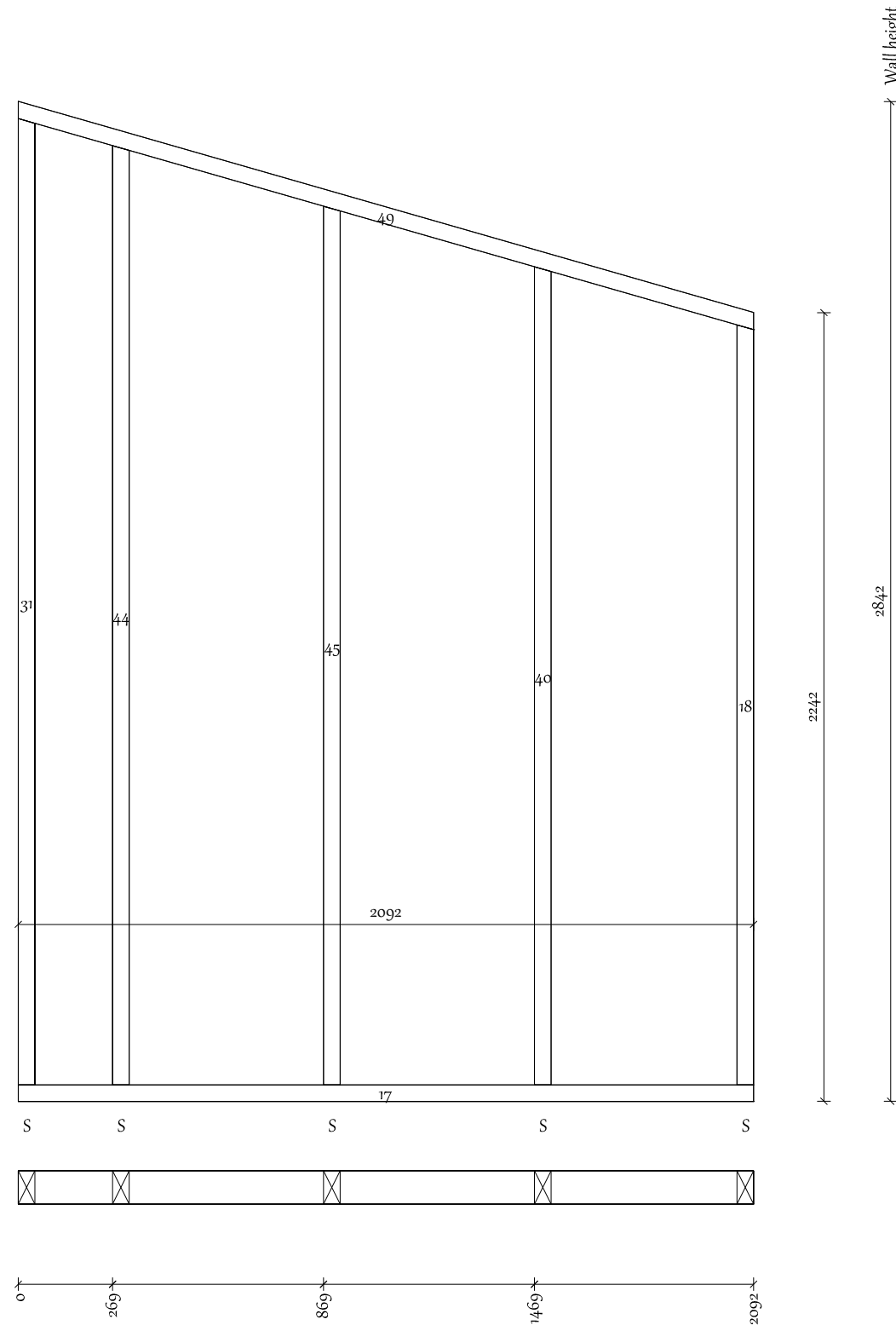
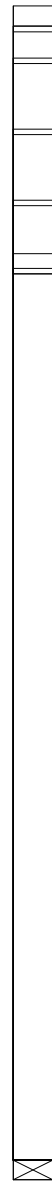

Client:	24_002 The Green Room - The Thirlmere Lodge Unit 142	Project number:		Weight:	41kg
Site Address:		Drawn By:		Multiwall No.:	
		W/O:		Panel No.:	S2
Title:		Date:	15/01/2024	Nailing Spec.:	



Internal 47x95 47x95

Diagonal: 5376

Prefabricated Cuts				
Bottom plate				
Nr.	Dimension	Length	Angle	Amount
21	47 x 95	4555	90>90 - 90>90	1
Top plate				
Nr.	Dimension	Length	Angle	Amount
47	47 x 95	4555	90>90 - 90>90	1
21	47 x 95	4555	90>90 - 90>90	1
Stud				
Nr.	Dimension	Length	Angle	Amount
27	47 x 95	535	90>90 - 90>90	6
30	47 x 95	2595	90>90 - 90>90	4
48	21 x 95	2595	90>90 - 90>90	1
53	47 x 95	2715	90>90 - 90>90	3
52	47 x 95	2715	90>90 - 90>90	2
28	47 x 95	2715	90>90 - 90>90	4
Transom				
Nr.	Dimension	Length	Angle	Amount
15	47 x 95	900	90>90 - 90>90	2
50	120 x 95	994	90>90 - 90>90	1
29	120 x 95	1015	90>90 - 90>90	1

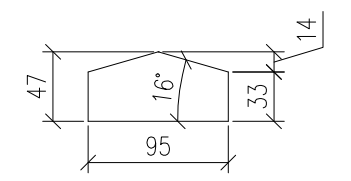
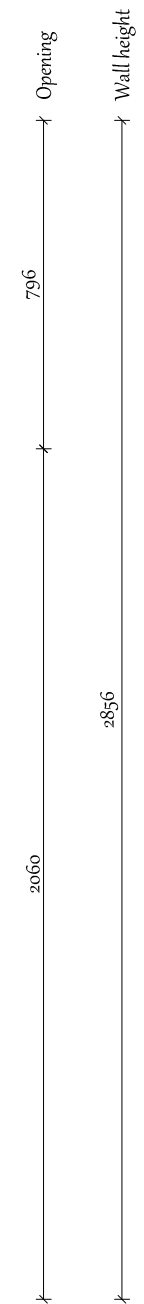
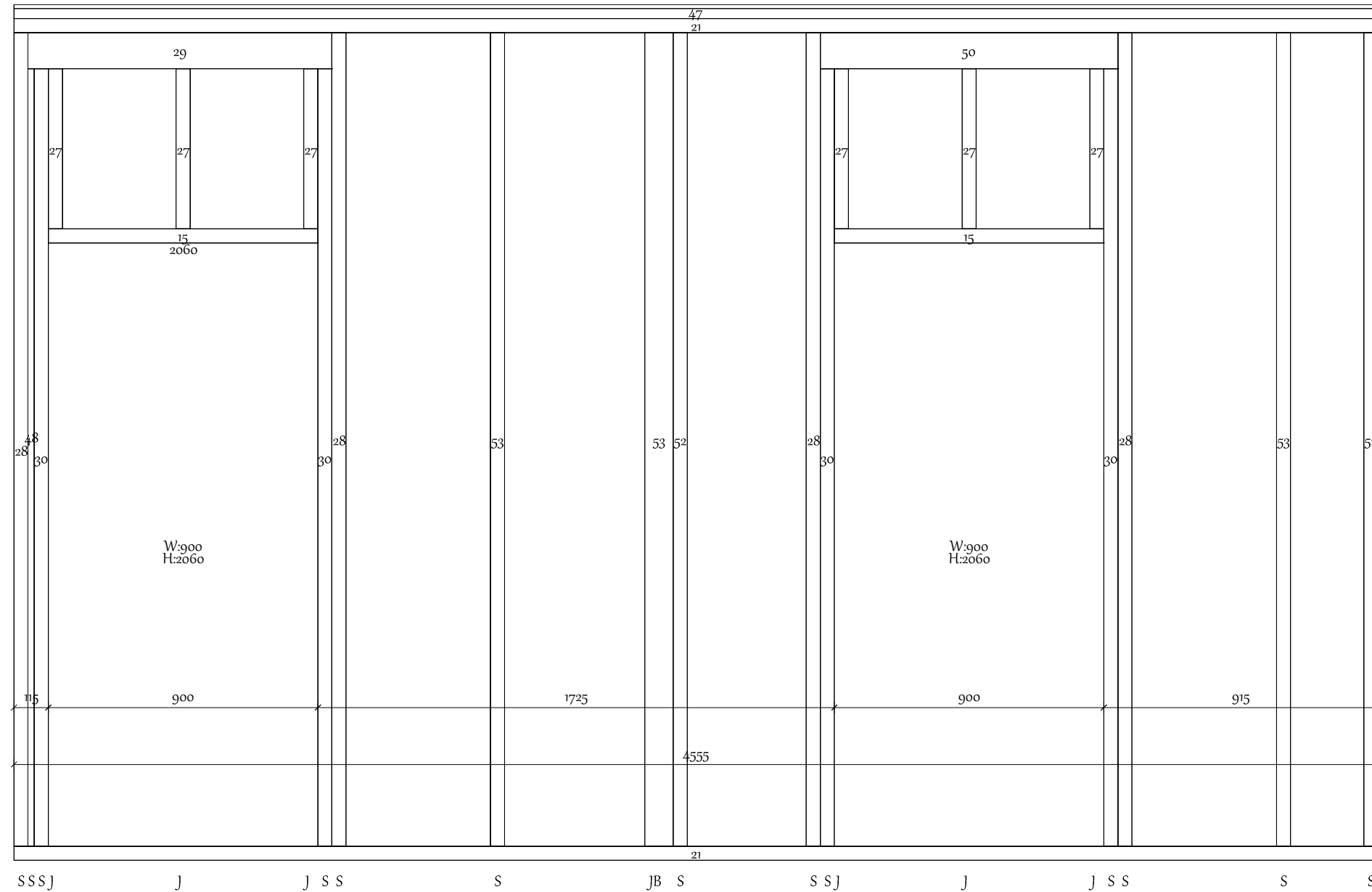

SSSJ J JSS S JB S SSJ J JSS S S

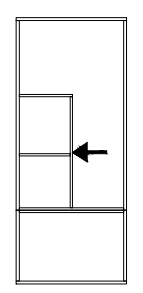
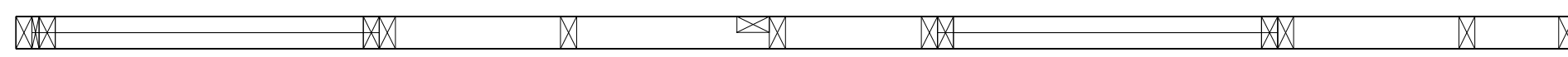

Client:	24_002 The Green Room - The Thirlmere Lodge Unit 142	Project number:		Weight:	204kg
Site Address:		Drawn By:		Multiwall No.:	
		W/O:		Panel No.:	S3
Title:		Date:	15/01/2024	Nailing Spec:	



Internal 47x95 47x95

Diagonal: 4832

Prefabricated Cuts				
Bottom plate				
Nr.	Dimension	Length	Angle	Amount
14	47 x 95	4280	90>90 - 90>90	1
Top plate				
Nr.	Dimension	Length	Angle	Amount
38	47 x 95	2240	90>74 - 90>74	2
Stud				
Nr.	Dimension	Length	Angle	Amount
26	47 x 95	372	90>90 - 90>74	1
34	47 x 95	494	90>90 - 90>74	1
43	47 x 95	617	90>90 - 90>74	1
18	47 x 95	2160	90>90 - 90>-74	2
40	47 x 95	2325	90>90 - 90>-74	2
39	47 x 95	2418	90>90 - 90>74	1
45	47 x 95	2497	90>90 - 90>-74	1
44	47 x 95	2669	90>90 - 90>-74	1
41	47 x 95	2690	90>90 - 90>74	1
35	47 x 95	2753	90>90 - 74>90	1
46	47 x 95	2753	90>90 - 74>90	1
42	47 x 95	2760	90>90 - 90>74	1
Transom				
Nr.	Dimension	Length	Angle	Amount
15	47 x 95	900	90>90 - 90>90	1

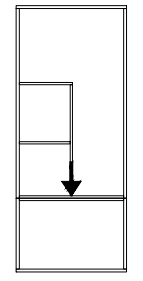
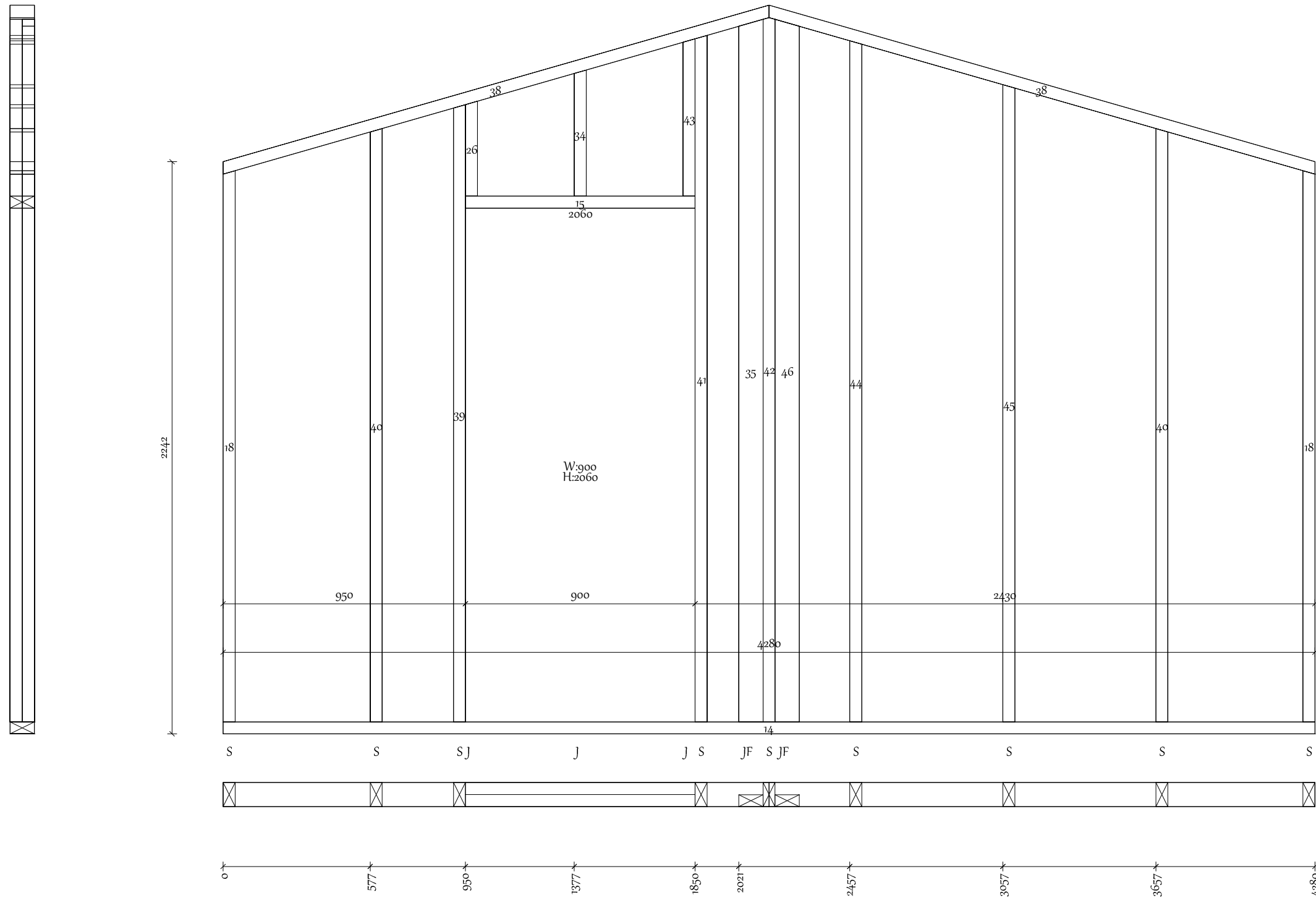

Client:	24_002 The Green Room - The Thirlmere Lodge Unit 142	Project number:		Weight:	107kg
Site Address:		Drawn By:		Multiwall No.:	
		W/O:		Panel No.:	S4
Title:		Date:	15/01/2024	Nailing Spec.:	



Internal 47x95 47x95

Diagonal: 4832

Prefabricated Cuts				
Bottom plate				
Nr.	Dimension	Length	Angle	Amount
14	47 x 95	4280	90>90 - 90>90	1
Top plate				
Nr.	Dimension	Length	Angle	Amount
54	47 x 95	2191	90>74 - 90>74	2
Stud				
Nr.	Dimension	Length	Angle	Amount
26	47 x 95	372	90>90 - 90>-74	1
34	47 x 95	494	90>90 - 90>-74	1
43	47 x 95	617	90>90 - 90>-74	1
18	47 x 95	2160	90>90 - 90>-74	2
24	47 x 95	2253	90>90 - 90>-74	1
40	47 x 95	2325	90>90 - 90>-74	1
39	47 x 95	2418	90>90 - 90>-74	1
45	47 x 95	2497	90>90 - 90>-74	1
37	47 x 95	2539	90>90 - 90>90	2
44	47 x 95	2669	90>90 - 90>-74	1
41	47 x 95	2690	90>90 - 90>-74	1
36	47 x 95	2746	90>90 - 90>-74	2
Transom				
Nr.	Dimension	Length	Angle	Amount
15	47 x 95	900	90>90 - 90>90	1

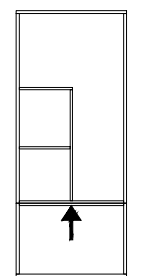
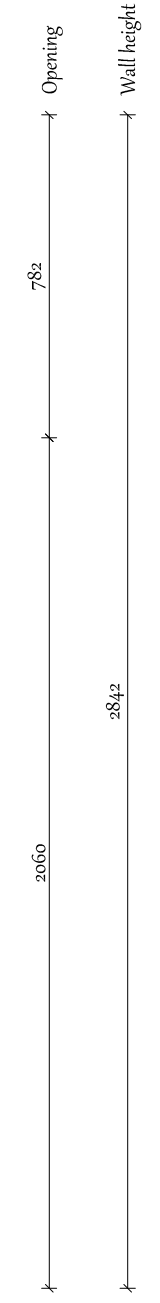
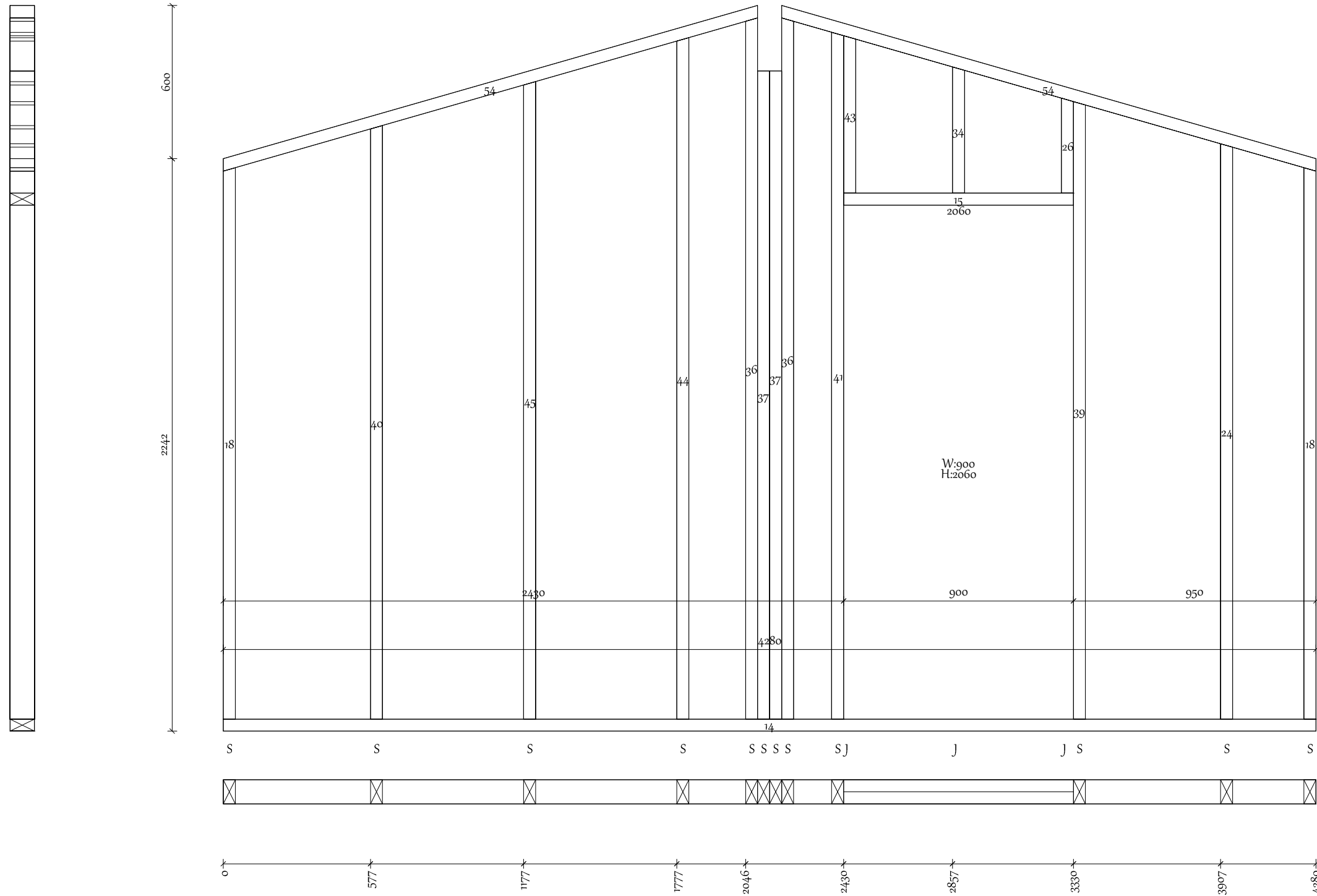

Client:	24_002 The Green Room - The Thirlmere Lodge Unit 142	Project number:		Weight:	112kg
Site Address:		Drawn By:		Multiwall No.:	
		W/O:		Panel No.:	S5
Title:		Date:	15/01/2024	Nailing Spec:	



Diagonal: 8425

Prefabricated Cuts				
Bottom plate				
Nr.	Dimension	Length	Angle	Amount
115	47 x 147	8050	90>90 - 90>90	1
End stud				
Nr.	Dimension	Length	Angle	Amount
94	47 x 170	8050	90>90 - 90>90	2
104	47 x 147	516	90>90 - 90>90	1
100	47 x 147	517	90>90 - 90>90	11
103	47 x 147	626	90>90 - 90>90	1
97	47 x 147	2393	90>90 - 90>90	1
Timber				
Nr.	Dimension	Length	Angle	Amount
96	47 x 147	2393	90>90 - 90>90	25
Plywood				
Nr.	Dimension	Length	Angle	Amount
95	18 x 170	8050	90>90 - 90>90	1
Sip Panels				
Sip170 Label	Width	Length	Thickness	
R1 - 1	608	2440	170	
R1 - 10	608	2440	170	
R1 - 11	608	2440	170	
R1 - 12	608	2440	170	
R1 - 13	718	2440	170	
R1 - 2	608	2440	170	
R1 - 3	608	2440	170	
R1 - 4	608	2440	170	
R1 - 5	608	2440	170	
R1 - 6	608	2440	170	
R1 - 7	608	2440	170	
R1 - 8	608	2440	170	
R1 - 9	608	2440	170	

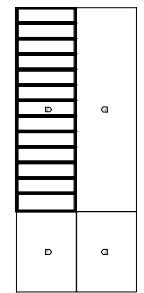
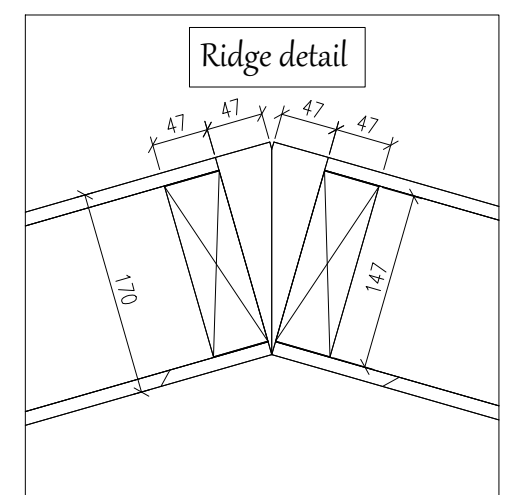
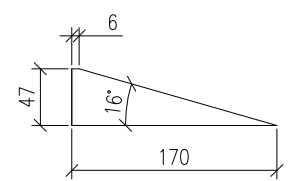
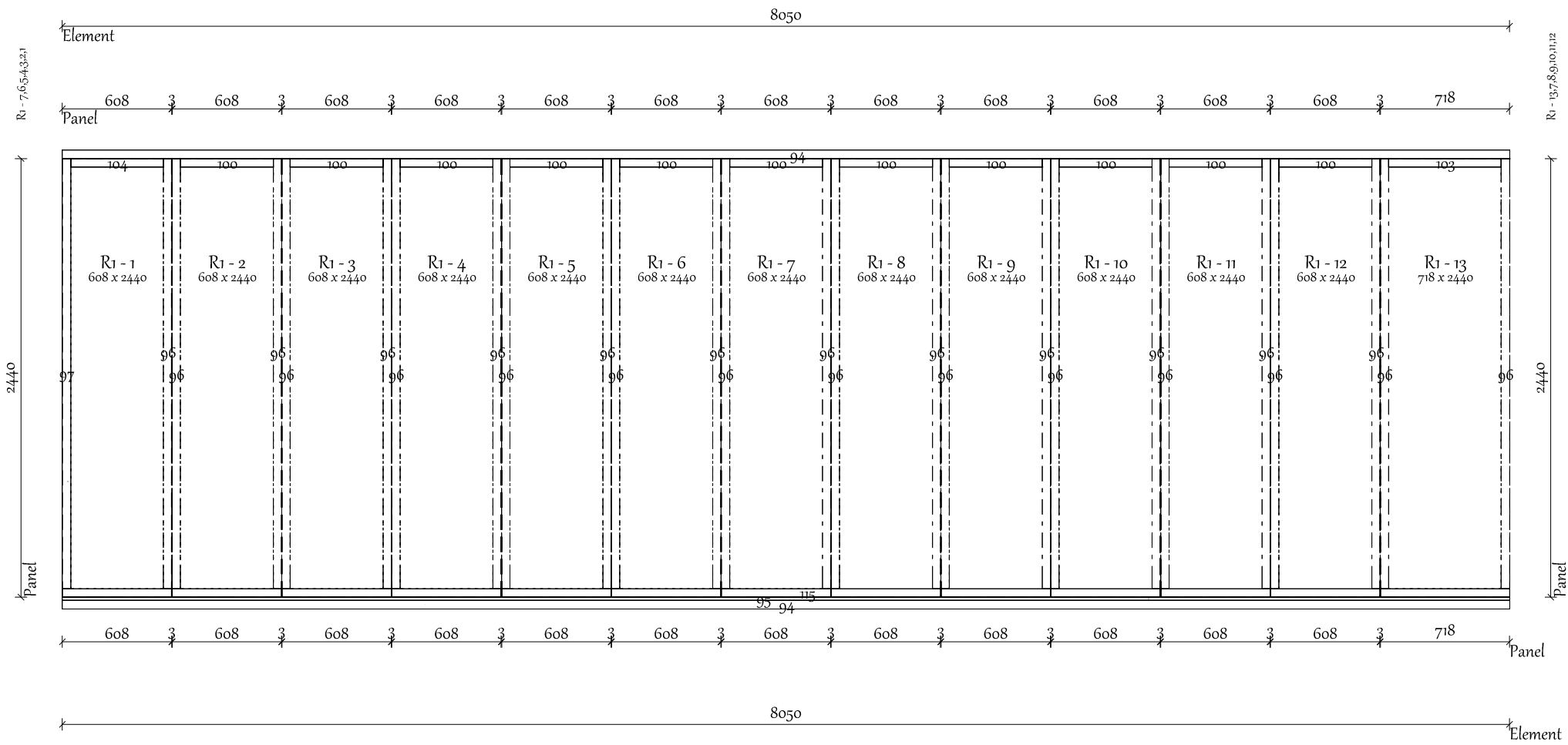

Client:	24_002 The Green Room - The Thirlmere Lodge Unit 1+2	Project number:		Weight:	570kg
Site Address:		Drawn By:		Panel No:	R1
Title:		W/O:			
		Date:	15/01/2024		



Diagonal: 8425

Prefabricated Cuts				
Bottom plate				
Nr.	Dimension	Length	Angle	Amount
115	47 x 147	8050	90>90 - 90>90	1
End stud				
Nr.	Dimension	Length	Angle	Amount
94	47 x 170	8050	90>90 - 90>90	2
104	47 x 147	516	90>90 - 90>90	1
100	47 x 147	517	90>90 - 90>90	11
103	47 x 147	626	90>90 - 90>90	1
97	47 x 147	2393	90>90 - 90>90	1
Timber				
Nr.	Dimension	Length	Angle	Amount
96	47 x 147	2393	90>90 - 90>90	25
Plywood				
Nr.	Dimension	Length	Angle	Amount
95	18 x 170	8050	90>90 - 90>90	1
Sip Panels				
Sip170 Label	Width	Length	Thickness	
R2 - 1	718	2440	170	
R2 - 10	608	2440	170	
R2 - 11	608	2440	170	
R2 - 12	608	2440	170	
R2 - 13	608	2440	170	
R2 - 2	608	2440	170	
R2 - 3	608	2440	170	
R2 - 4	608	2440	170	
R2 - 5	608	2440	170	
R2 - 6	608	2440	170	
R2 - 7	608	2440	170	
R2 - 8	608	2440	170	
R2 - 9	608	2440	170	

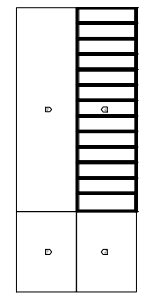
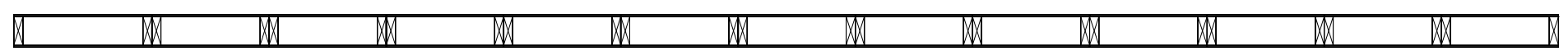
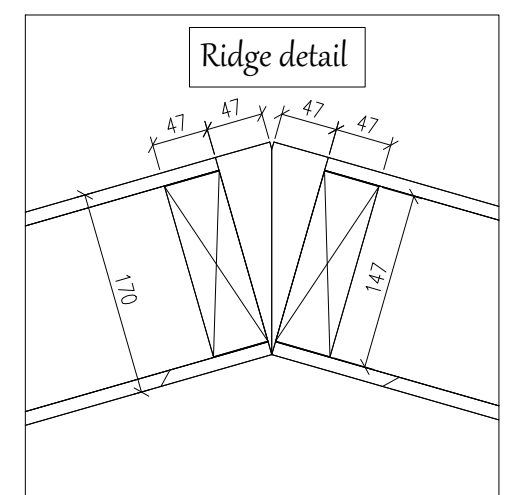
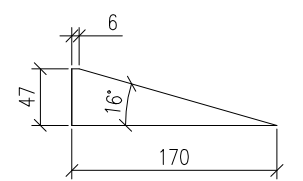
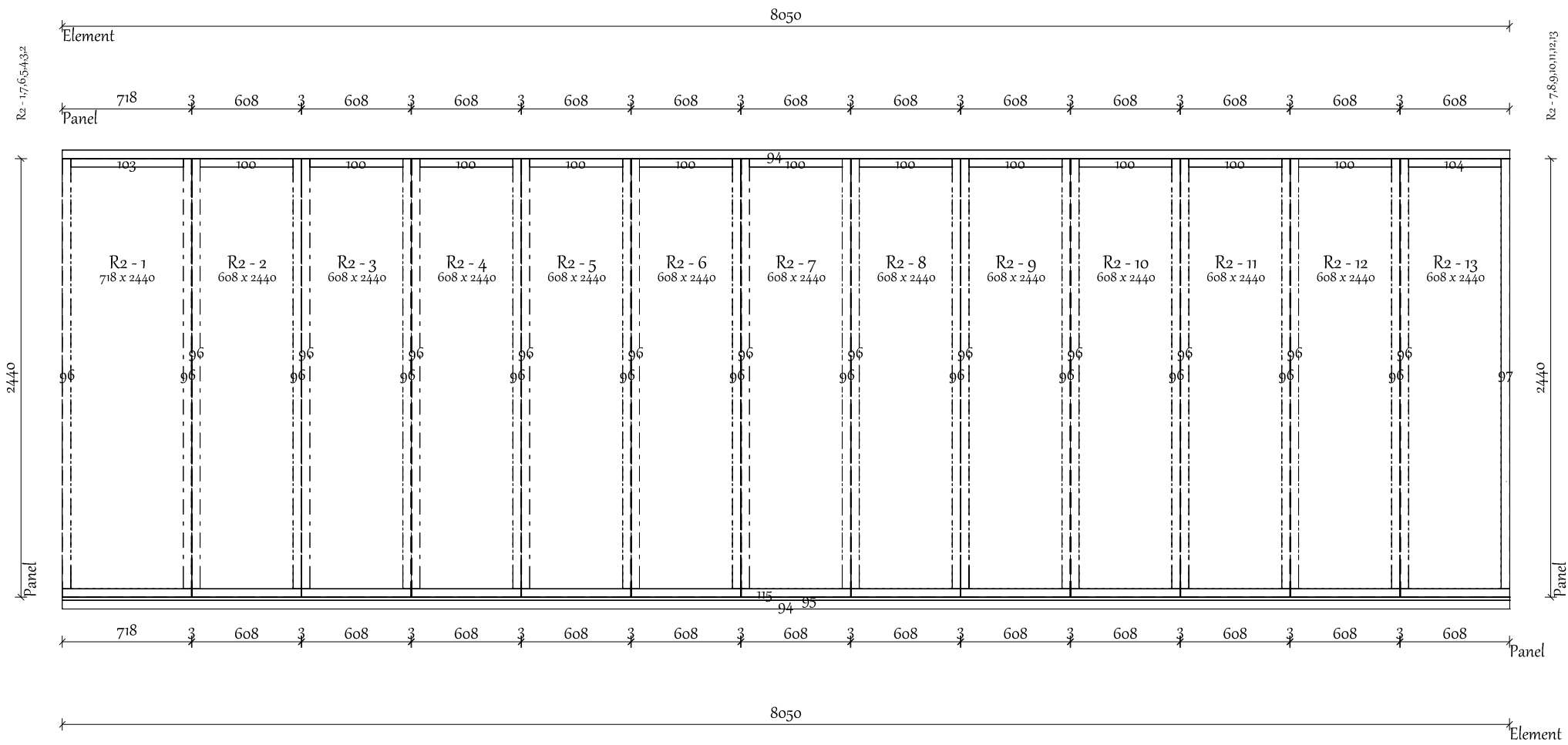

Client:	24_002 The Green Room - The Thirlmere Lodge Unit 1+2	Project number:		Weight:	570kg
Site Address:		Drawn By:		Panel No:	R2
Title:		W/O:			
		Date:	15/01/2024		



Diagonal: 4029

Prefabricated Cuts				
End stud				
Nr.	Dimension	Length	Angle	Amount
112	47 x 170	3170	90>90 - 90>90	2
98	47 x 147	516	90>90 - 90>90	1
99	47 x 147	517	90>90 - 90>90	3
101	47 x 147	634	90>90 - 90>90	1
97	47 x 147	2393	90>90 - 90>90	1
Bottom plate				
Nr.	Dimension	Length	Angle	Amount
113	47 x 147	3170	90>90 - 90>90	1
Timber				
Nr.	Dimension	Length	Angle	Amount
96	47 x 147	2393	90>90 - 90>90	9
Plywood				
Nr.	Dimension	Length	Angle	Amount
111	18 x 170	3170	90>90 - 90>90	1
Sip Panels				
SIP170 Label	Width	Length	Thickness	
R3 - 1	726	2440	170	
R3 - 2	608	2440	170	
R3 - 3	608	2440	170	
R3 - 4	608	2440	170	
R3 - 5	608	2440	170	

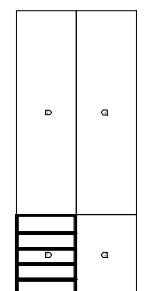
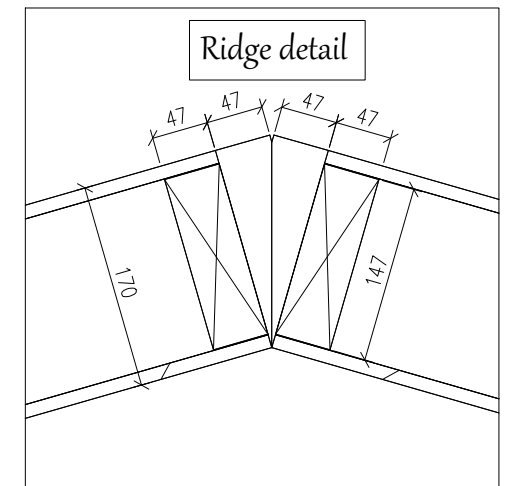
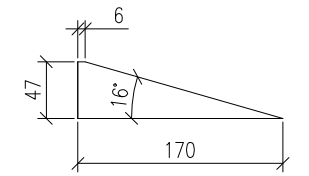
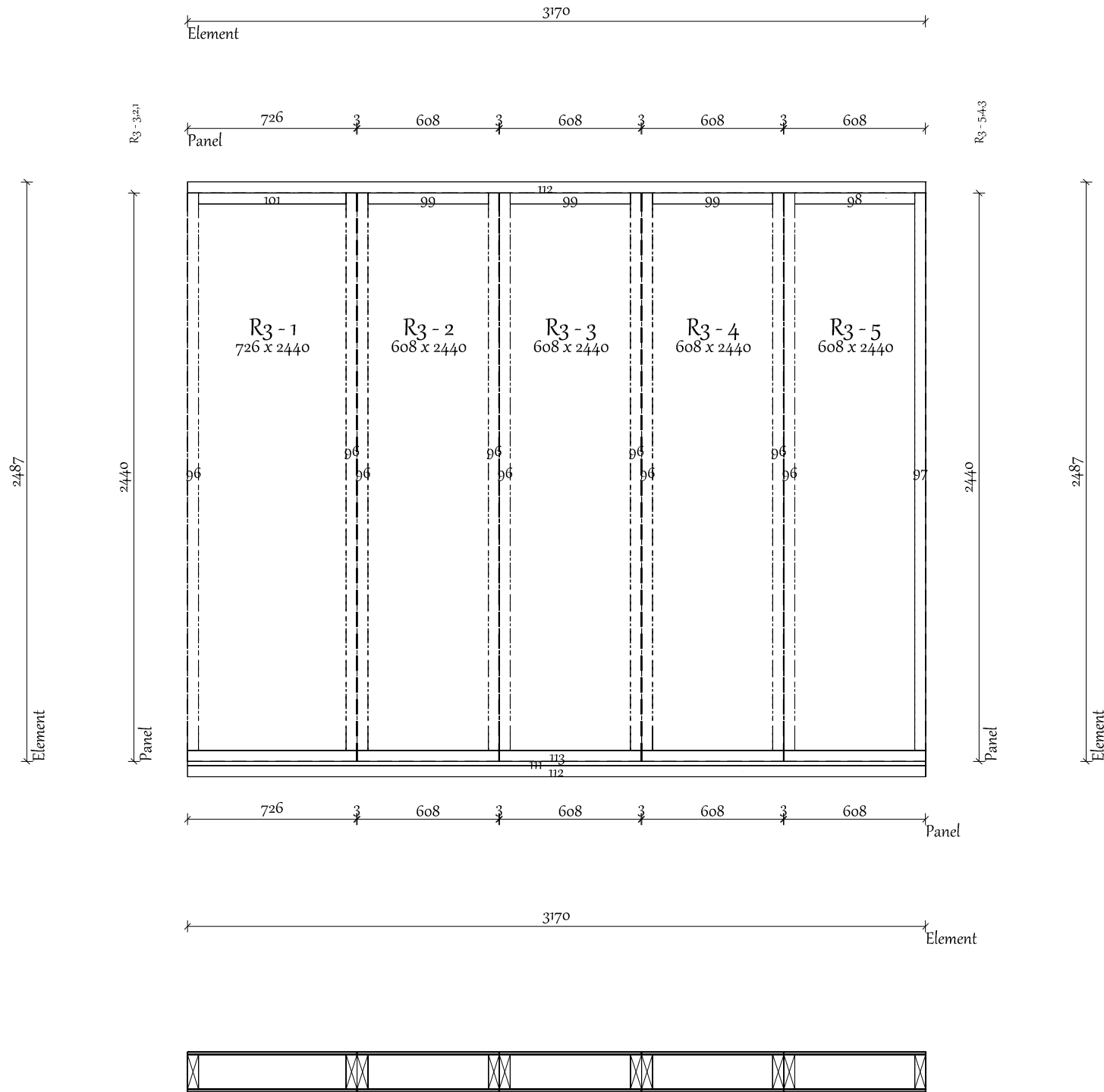

Client:	24_002 The Green Room - The Thirlmere Lodge Unit 1+2	Project number:		Weight:	376kg
Site Address:		Drawn By:		Panel No:	R3
		W/O:			
Title:		Date:	15/01/2024		



Diagonal: 4029

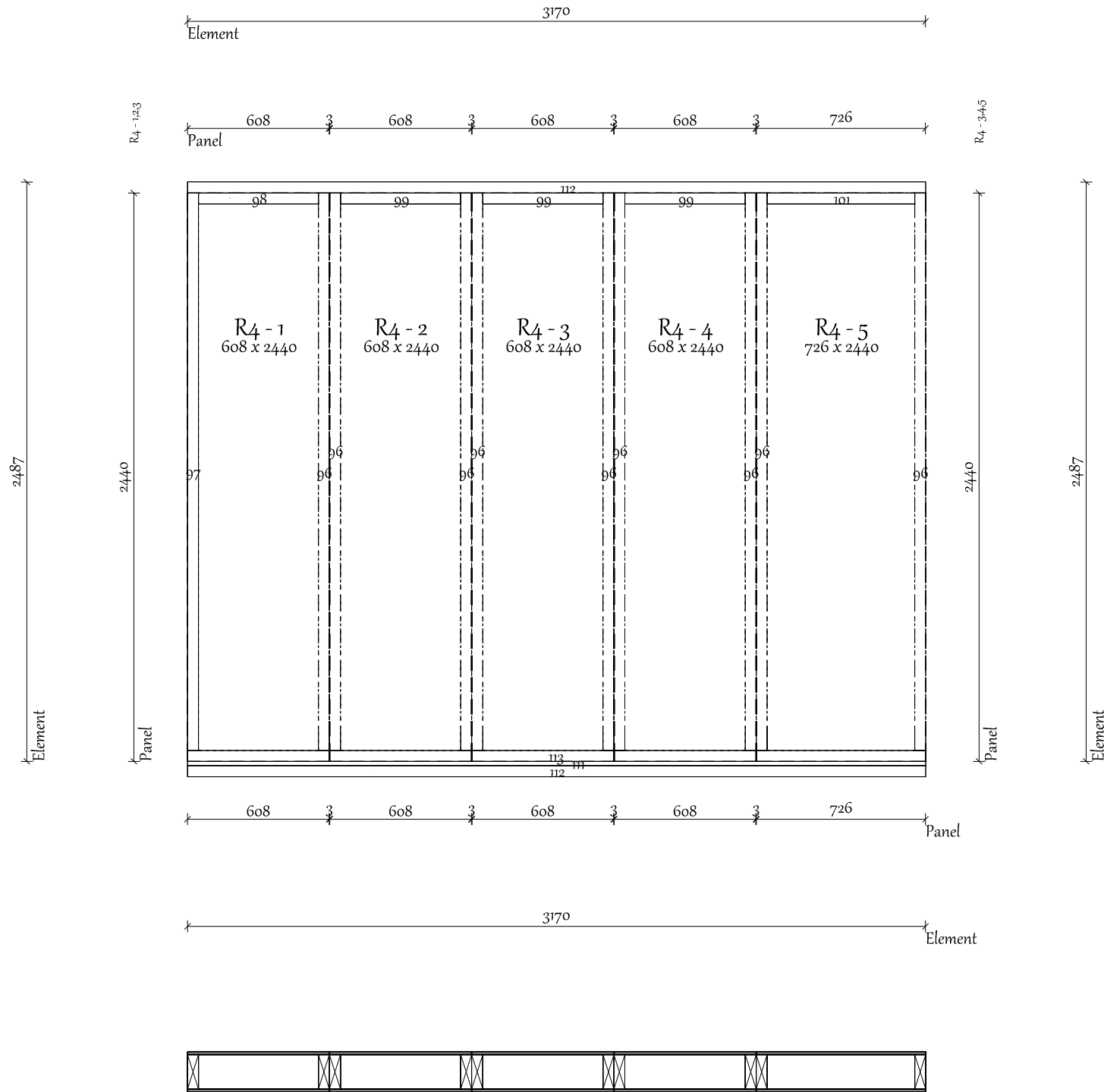

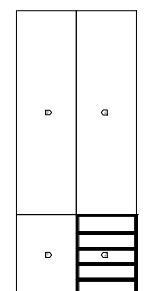
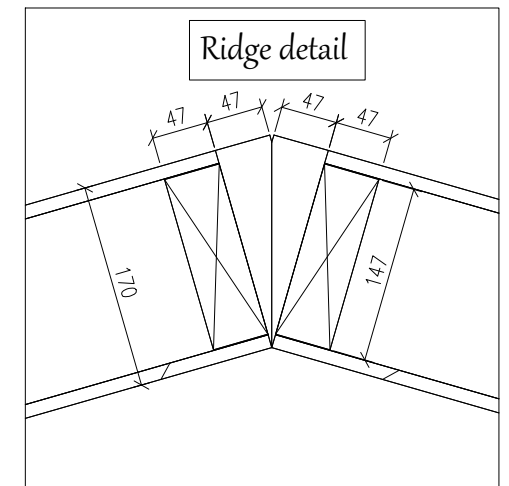
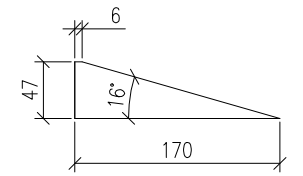

Prefabricated Cuts				
End stud				
Nr.	Dimension	Length	Angle	Amount
112	47 x 170	3170	90>90 - 90>90	2
98	47 x 147	516	90>90 - 90>90	1
99	47 x 147	517	90>90 - 90>90	3
101	47 x 147	634	90>90 - 90>90	1
97	47 x 147	2393	90>90 - 90>90	1
Bottom plate				
Nr.	Dimension	Length	Angle	Amount
113	47 x 147	3170	90>90 - 90>90	1
Timber				
Nr.	Dimension	Length	Angle	Amount
96	47 x 147	2393	90>90 - 90>90	9
Plywood				
Nr.	Dimension	Length	Angle	Amount
111	18 x 170	3170	90>90 - 90>90	1
Sip Panels				
SIP170 Label	Width	Length	Thickness	
R4-1	608	2440	170	
R4-2	608	2440	170	
R4-3	608	2440	170	
R4-4	608	2440	170	
R4-5	726	2440	170	



Client:	24_002 The Green Room - The Thirlmere Lodge Unit 1+2	Project number:		Weight:	376kg
Site Address:		Drawn By:		Panel No:	R4
Title:		W/O:			
		Date:	15/01/2024		

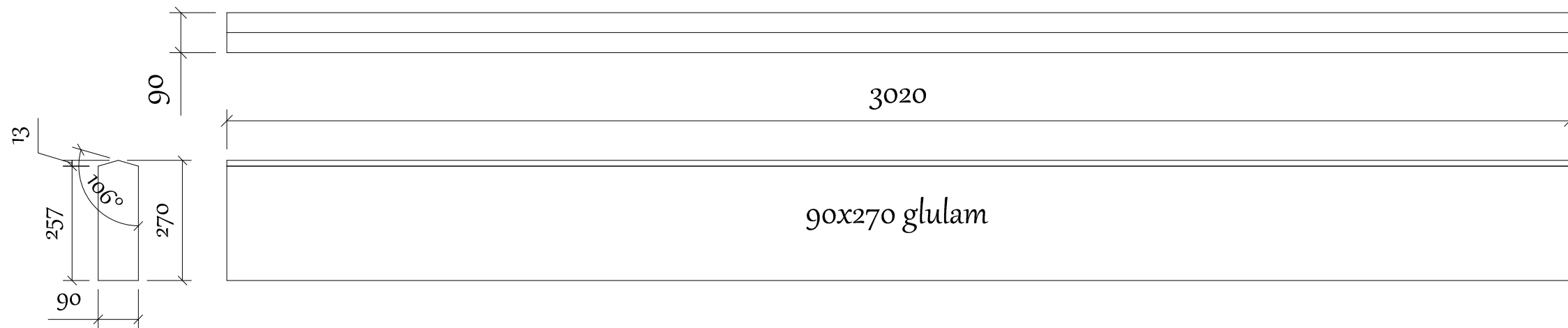
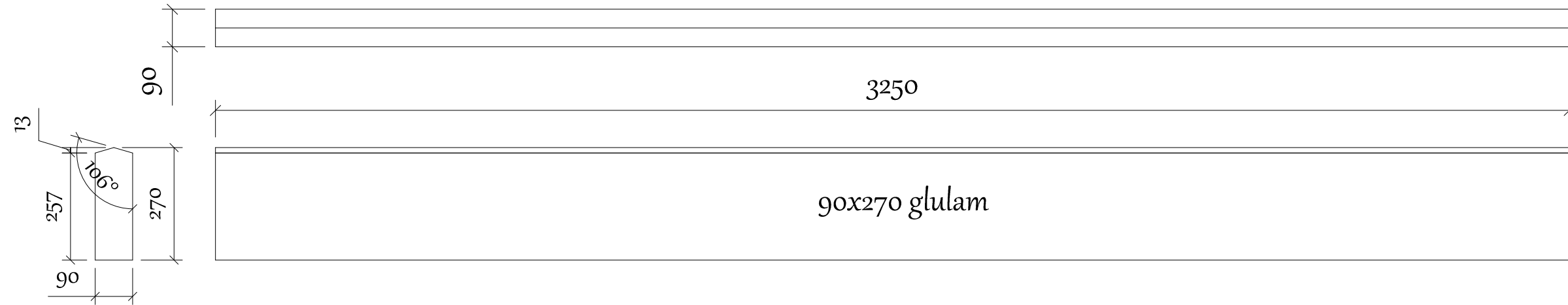



Project : 24_002 The Green Room - The Thirlmere Lodge Unit 1+2				The Green Room Unit C Marconi Courtyard Brunel Rd, Earlstrees Est.	
Project address :				Corby, Northants NN17 4LT	
Date: January 15, 2024	Title: Glulams	Rev: 0	Web: the-green-room.co.uk Tel: 01536 358387 Email: info@the-green-room.co.uk		