

upward view

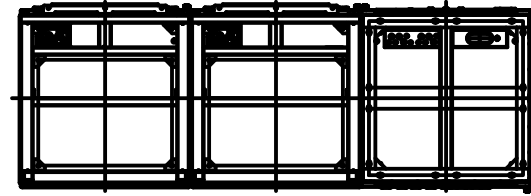

front view

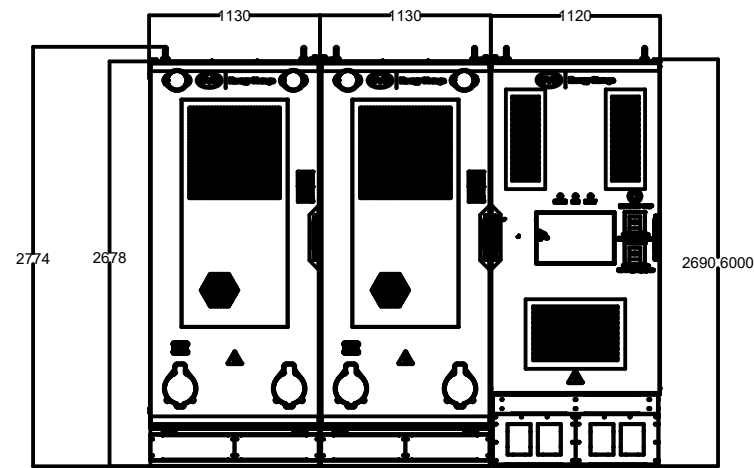

left view

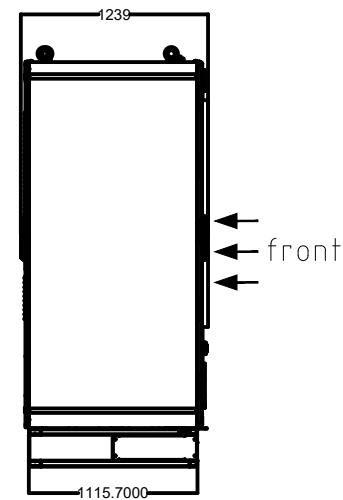

rear view

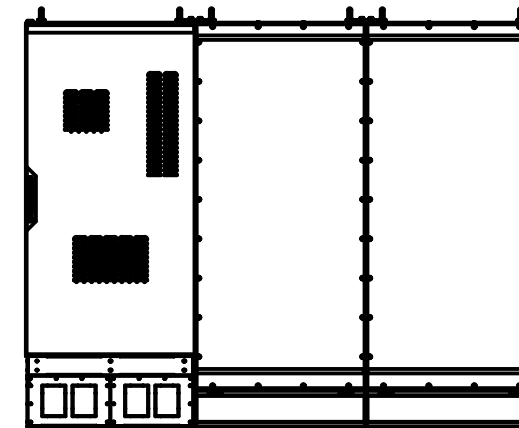

vertical view

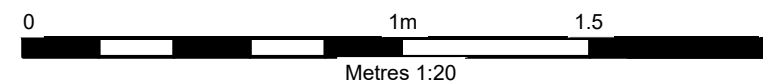
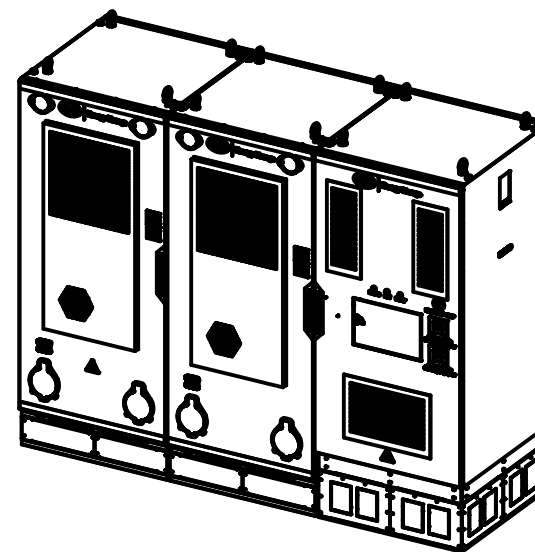
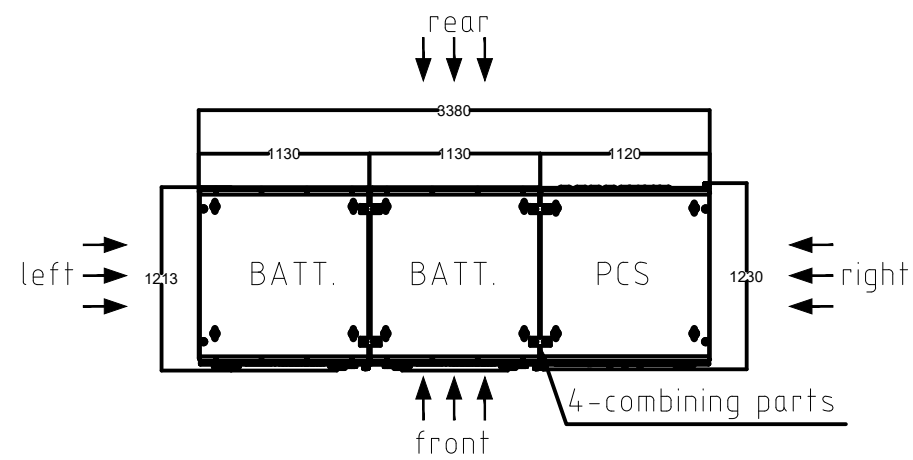

BATTERY BOX
LEADING THE CHARGE

amp CLEAN ENERGY
AMP CLEAN ENERGY
1 DOVER STREET
LONDON
W1S 4LD

200kW / 800kWh
MICRO ENERGY STORAGE UNIT

BATTERY BOX
Plan depicting Battery Equipment

**SMART STRING ESS
PLAN AND ELEVATIONS**

PLAN 4

Scale 1:20 @ A3