

Mass: 384.0 kg

SHIRE
BUILT AROUND OUR REPUTATION



Follow and Tag Us: @shiregardenbuildings

Batch No: 5999

© Delmora 8x16

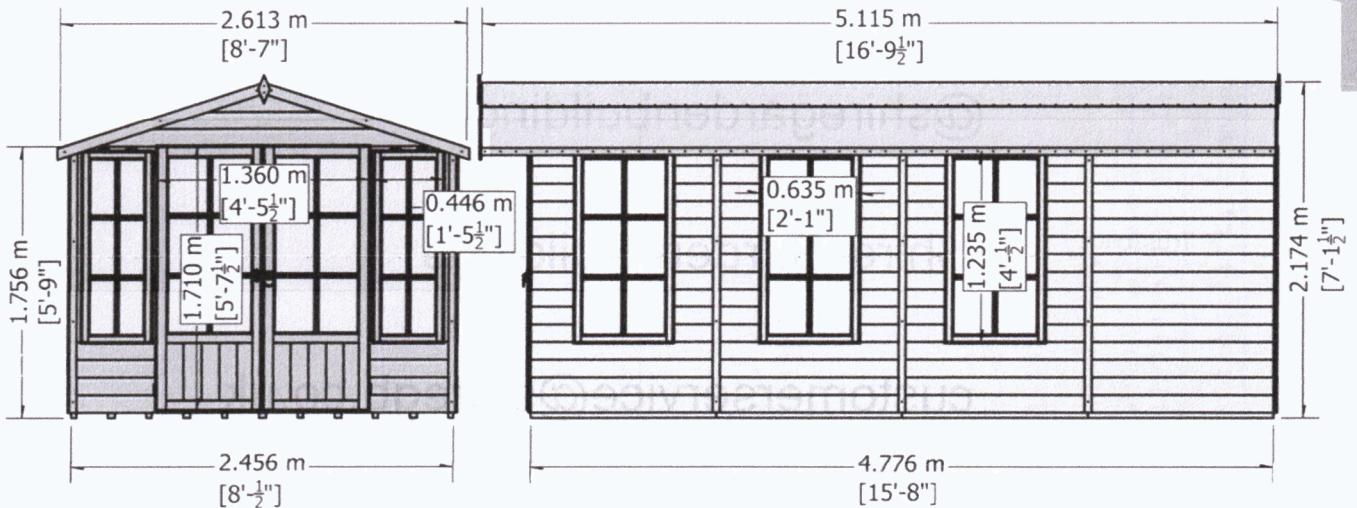
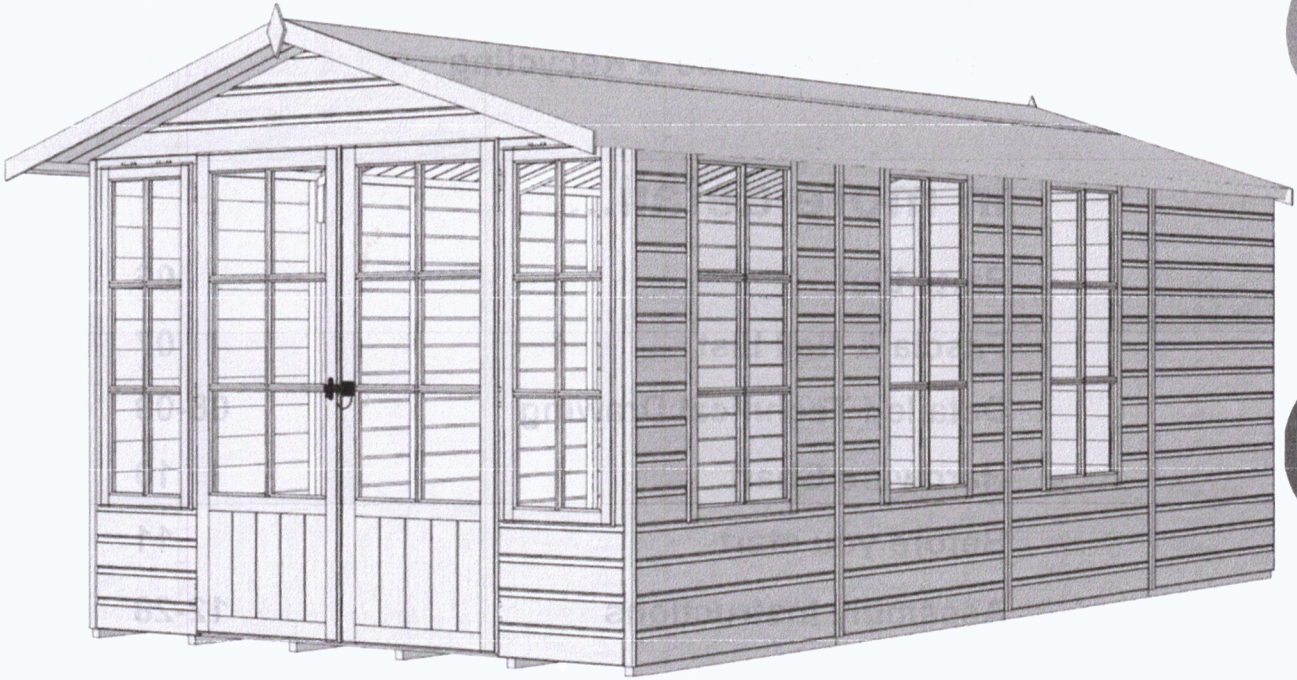

Version 02 Sasha Leney 29/09/2022

**These instructions are for your safety. Please read through them thoroughly before use.
PLEASE KEEP THIS LEAFLET FOR FUTURE REFERENCE**

Let's get started...

Important information...



Safety	03
Preparation of base	04
Warranty	04
Care, maintenance & Recycling	05

In more detail...



Parts List	06
Fascia & Nail List	07
Detailed Technical Drawing	08-09
Hardware Chart	10
Before you start	11
Assembly Instructions	12-28

Like us, Follow us, Recommend us & Tag us



Shire Garden Buildings



@shiregardenbuildings



Shire Garden Buildings



customerservice@shiregb.co.uk



Brigstock Road Wisbech Cambridgeshire PE13 3JJ
Tel 01945 465 295

Safety

Check that you have noted all the following instructions:



- We advise the use of non slip protective gloves throughout the assembly process.
- We advise the use of steel capped protective footwear throughout the assembly process.
- We advise that you use a helper to hold the glass in position whilst you nail the beading in place.
- We advise the use of protective headwear and safety goggles throughout the assembly process.
- Where a ladder is in use another person must hold the ladder.
- Do not attempt to work in windy conditions.
- We advise the use of a scaffold tower when fitting the roof for felting or if you cannot reach from the ground.
- Do not allow children near the tools and work area.
- Follow any safety precautions quoted by the manufacturer for any equipment you use.
- Check all parts before assembly.
- Only use child and animal safe wood preservative.
- Do not use creosote.
- Allow the wood preservative to fully dry before use.
- Regularly check the building for wear and tear.

Important!



EVERY PRECAUTION IS TAKEN TO ENSURE THAT YOUR BUILDING HAS NO ELEMENT INCORRECTLY PLACED OR POSSIBLY HAZARDOUS, HOWEVER PRIOR TO USE PLEASE CHECK ALL SURFACES FOR THE FOLLOWING:

- (1) RAISED GRAIN, SPLINTERS: Sand down timber to smooth finish
- (2) NAIL/SCREW/PIN HEADS PROUD: Tap home to be flush with surface of timber.
- (3) DAMAGED SCREW HEADS RESULTING IN SHARP SPLINTERS OF METAL: Replace.
- (4) SHARP ENDS OF NAILS/ SCREWS/ PINS PROTRUDING THROUGH THE PANEL: Remove and Reposition.
- (5) ENSURE ALL PARTS ARE SECURED AGAINST REASONABLE FORCE: Remove and Refit.
- (6) ENSURE THERE ARE NO LOOSE PARTS: Remove and Refit/Discard.



IMPORTANT ! For your safety please read carefully the safety warnings

Preparation of base...

We recommend that the base onto which your building will stand should be at least 75mm larger in each direction than the total floor size of the building.

- **Actual floor area of the building:** 2456mm x 4776mm
- **Total height clearance:** 2174mm
- **Roof size:** 2613mm x 5115mm

The chosen position in your garden for your building should be excavated to a depth of 75mm to allow a base of sand, onto which paving slabs can be evenly laid.

You may also use an adjustable timber base or a concrete base. Whatever base you decide upon IT MUST BE LEVEL AND FIRM.

Warranty...

10 Year anti-rot warranty subject to the following:

- The building must be raised so it is not in contact with any water retaining base surface (for example grass).
- This can be achieved using a timber, concrete or slab base.
- When using a concrete or slab base use damp proofing strips under the bearers.
- The building must have been completely treated and sealed immediately prior to assembly.
- The building must have been re-treated and re-sealed annually.

NOTE: Wood is a natural product, and therefore the following are excluded from the warranty:

- Colour change.
- Warping.
- Splitting.

The following are also excluded:

- Damage resulting from poor assembly.
- Poor treatment application.
- Poor care and maintenance.
- Changes to the design.
- Misuse.
- General wear and tear.

The 5 golden rules of care:

- (1) Ensure your base is level and firm.
- (2) Ensure the building is not sitting directly on the ground using damp proof membrane or the optional timber base.
- (3) Ensure every piece of timber and surface, especially that is hidden upon assembly, is treated with a top quality wood preservative at least twice (before assembly). Turn the panels upside down whilst painting so the treatment runs into the seams.
- (4) Garden buildings are not waterproof, therefore you must seal between all the panels with a silicone based sealant.
- (5) Regularly check your roofing felt for weather damage and leaks.

The 6 golden rules of maintenance:

- (1) Visually check for weather damage.
- (2) Check and replace if necessary any silicone sealant if used on your building.
- (3) Check the roofing material for wear.
- (4) The doors and windows may require periodical adjustment.
- (5) Ensure your building is well ventilated especially during hot weather.
- (6) During extremely hot periods, humidify your building to prevent the timber from drying out.

Recycling and disposal:

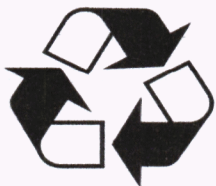

packaging

1. Pallet and timber widely recycled.
2. Cardboard widely recycled.
3. Plastic strapping subject to local regulations.
4. Plastic sheeting subject to local regulations.



Building

1. Timber widely recycled.
2. Metal fixings widely recycled.
3. Glass widely recycled.
4. **Roofing felt not currently recycled.**

Description
(part No) - Qty

Stacked Parts List

FLOOR PANEL
(A07907)x04

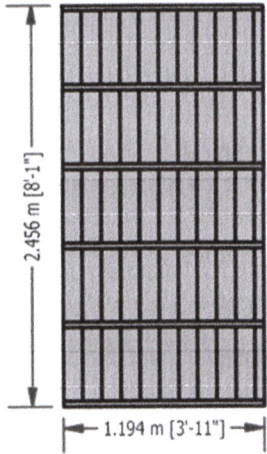

ROOF PANEL
(A07908)x06

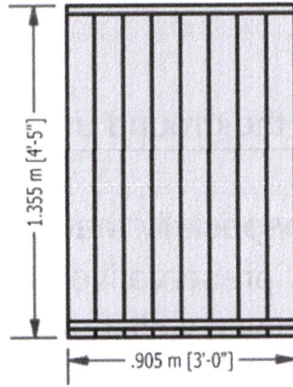

EXTENSION ROOF PANEL
(A07917)x04

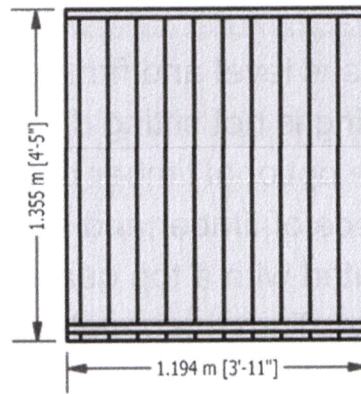

PLAIN PANEL
(A07909)x07

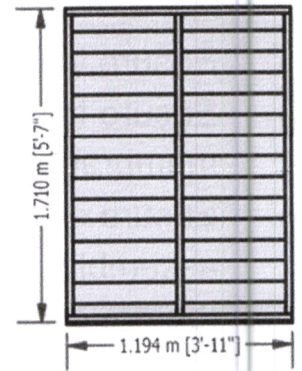

WINDOW PANEL
(A07910)x03

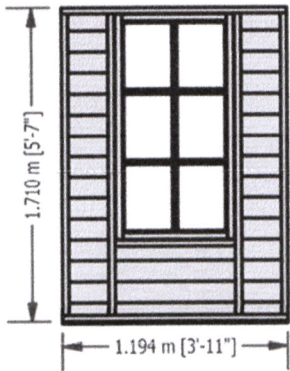

WINDOW PANEL 514
(A07911)x02

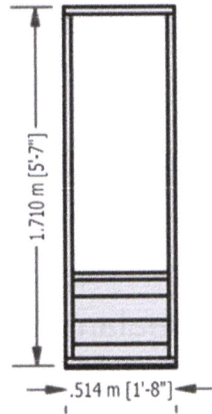

GABLE
(A07912)x02

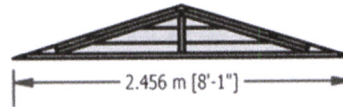

ROOF BEARER 34X34
(A07913)x16

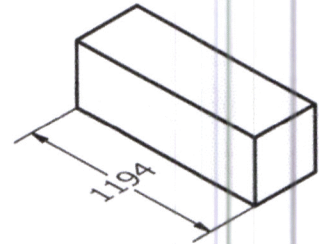

TRUSS FRAME
(A07914-1)x06

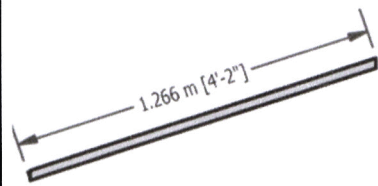

TRUSS BRACE
(A07914-2)x03

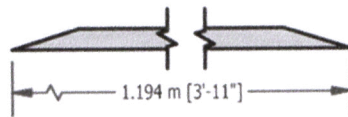

FELT STRIP 5.3M
(A4506)x03

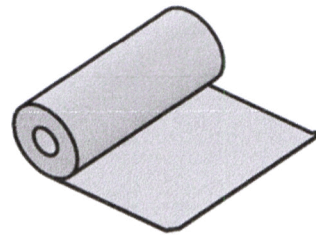

GLASS 268X373
(A0020)x30

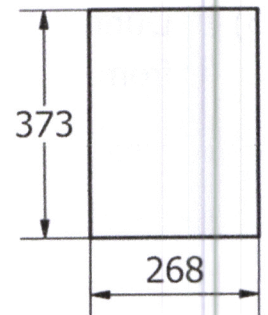

GLASS 175X373
(A1173)x12

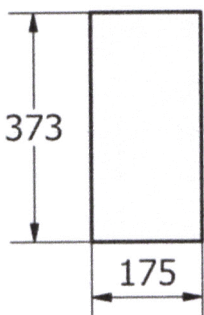

WINDOW SASH
(B0033)x02

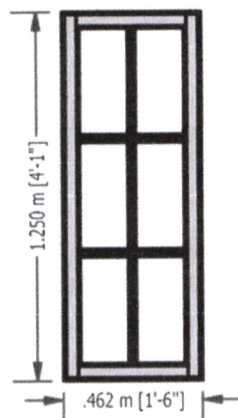

PRIMARY DOOR
(B0055-P)x01

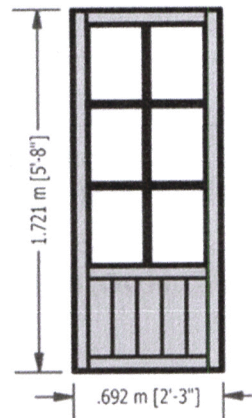

SECONDARY DOOR
(B0055-S)x01

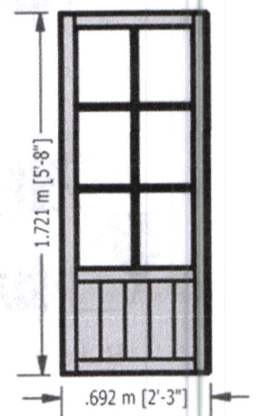

Description
(part No) - Qty

Fascia and Nail Bag Parts List

TRUSS BLOCK
(A07914-3)x06

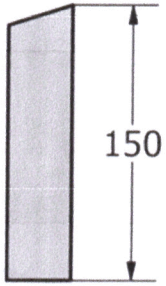

JOINER 34X46X230
(A0002)x15

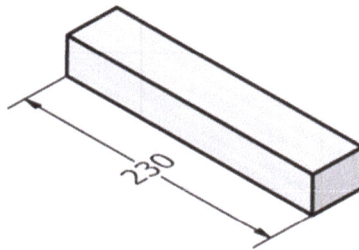

ROOF OVERHANG 34X34
(A0011)x02

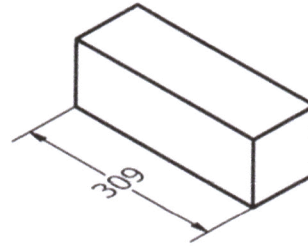

COVERSTRIP 12X46X1720
(A0016)x11

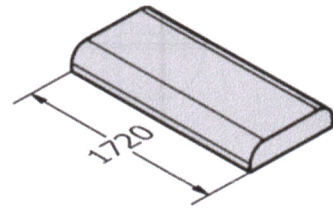

BEADING 377MM
(A0021)x84

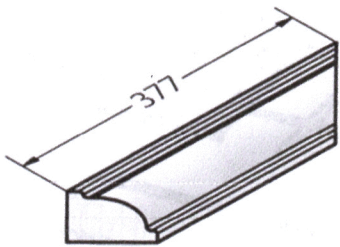

BEADING 270MM
(A0022)x60

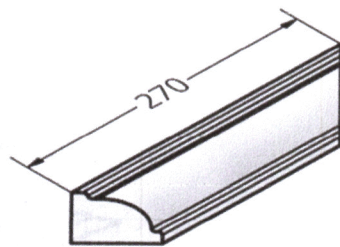

BEADING 177MM
(A3418)x24

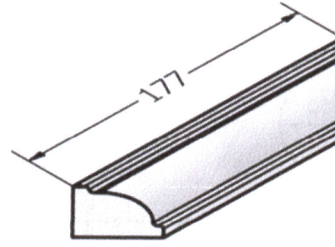

FASCIA 12X70X1415
(A07915)x04

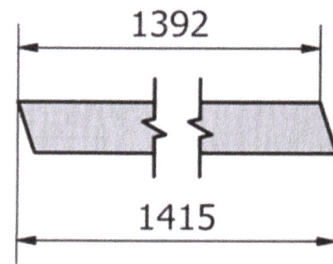

DIAMOND
(A0019)x02



STORM HINGE 2.5"
(A0013)x10

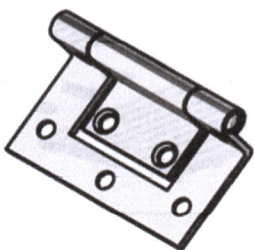

BARREL BOLT
(A0014)x02

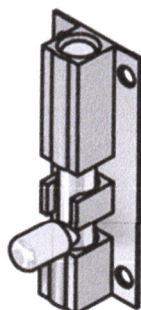

GATE LATCH
(A0015)x01



CASEMENT STAY
(A0038-1)x02

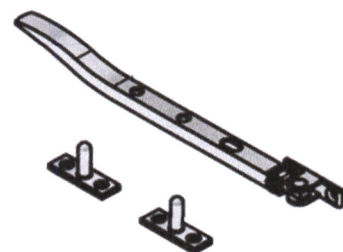

In more detail.....

EXTENSION ROOF PANEL
A07917

ROOF OVERHANG 34X34
A0011

BARREL BOLT
A0014

STORM HINGE 2.5"
A0013

WINDOW SASH
B0033

GLASS 268x373
A0020

BEADING 177mm
A3418

GLASS 175x373
A1173

BEADING 377mm
A0021

BEADING 270mm
A0022

GATE LATCH
A0015

CASEMENT STAY
A0038-1

SECONDARY DOOR
B0055-S

PRIMARY DOOR
B0055-P

WINDOW PANEL 514
A07911

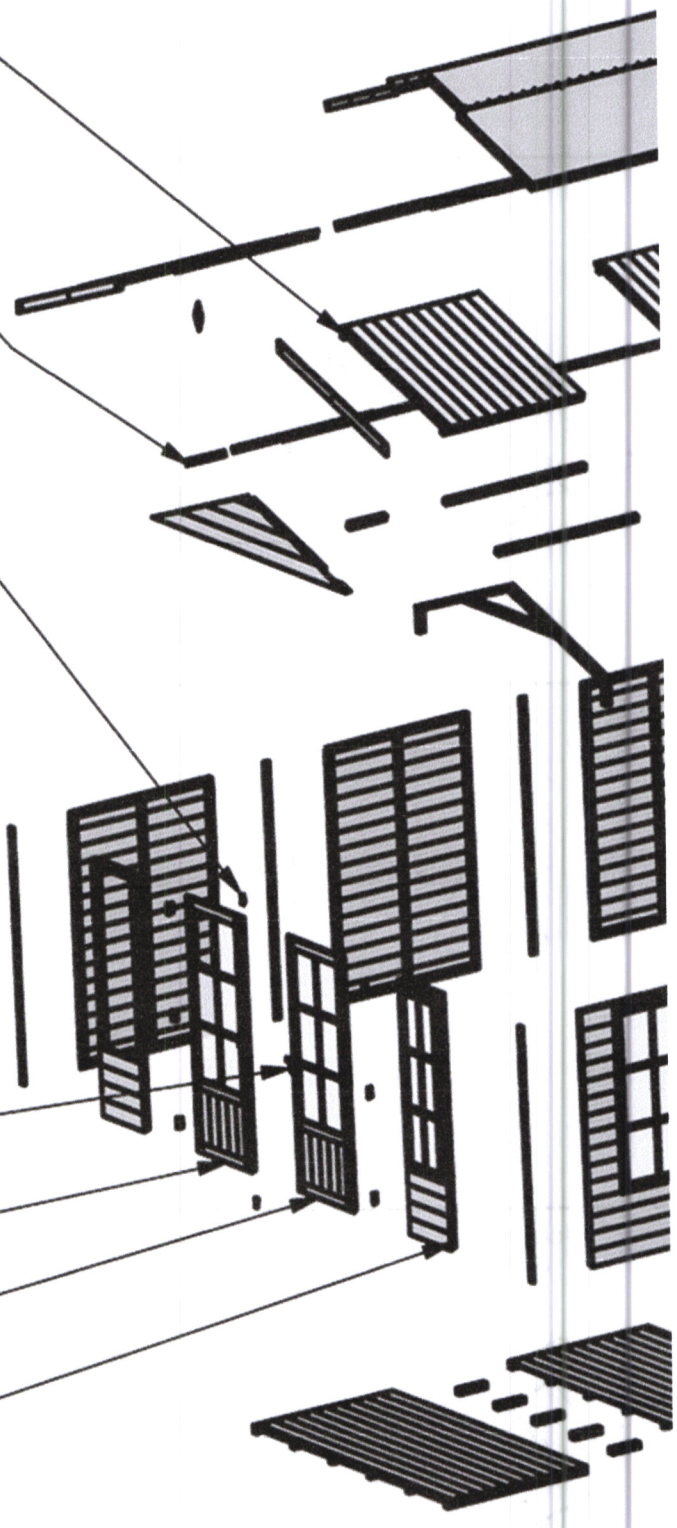

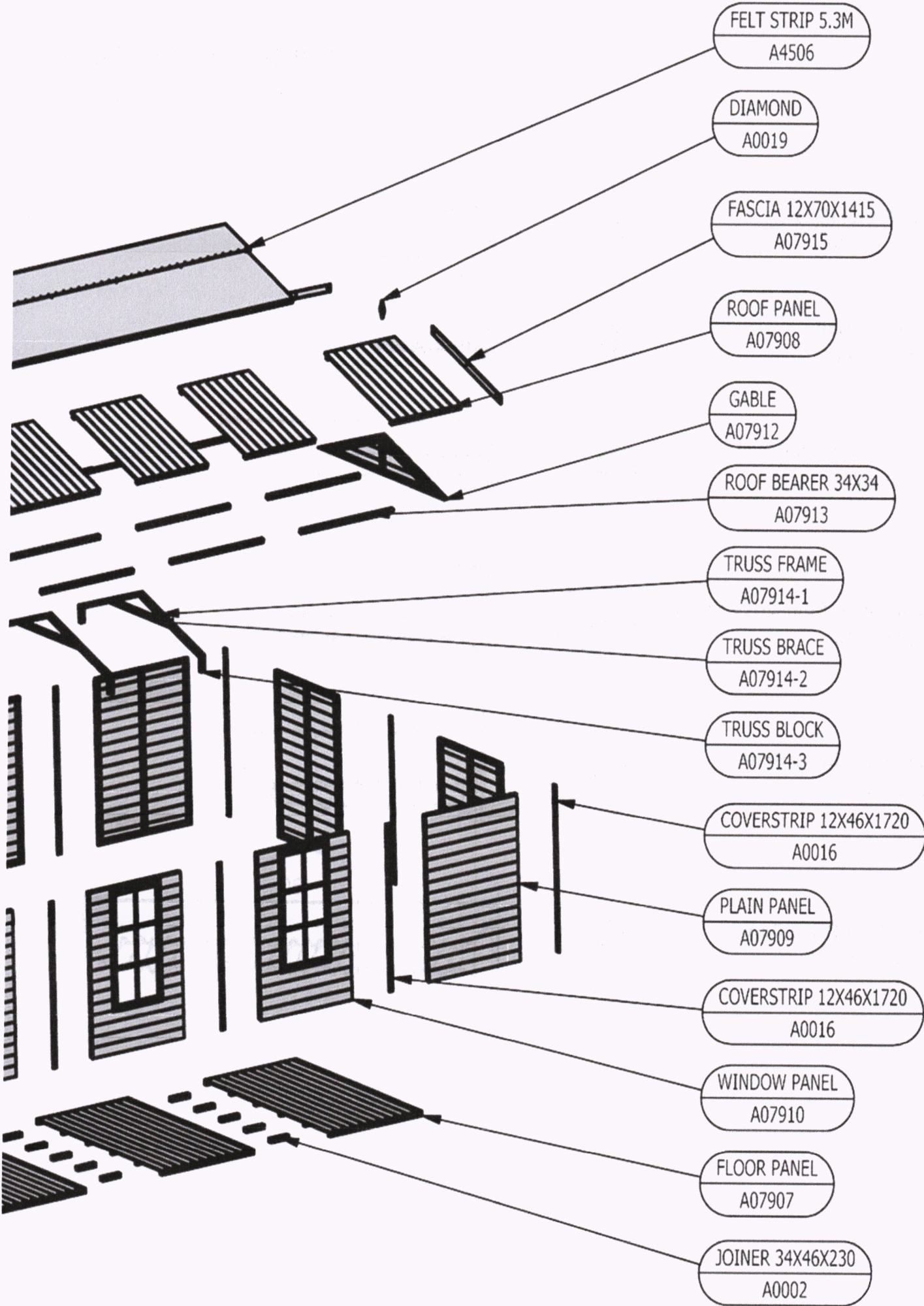

In more detail.....

Hardware Chart Scale 1:1

16mm Panel Pins
(A0024) x 420

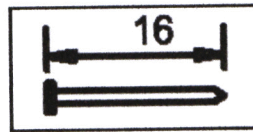

13mm Felt Nail
(A0023) x 250

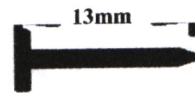

40mm Round Head Nail
(A0025) x 208

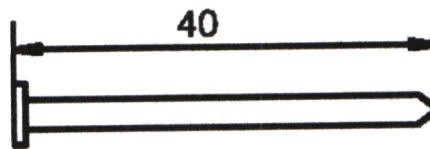

Black 25mm Posi-Drive Screw
(A0031) x 10

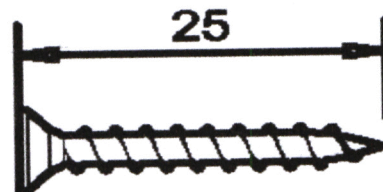

25mm Posi-Drive Screw
(A0032) x 90

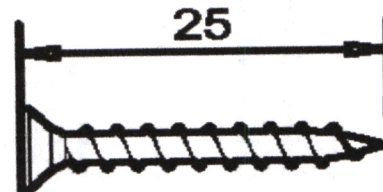

60mm Posi-Drive Screw
(A0035) x 165

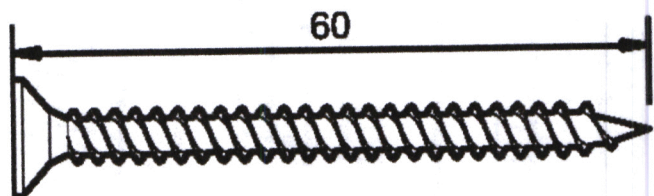

Before you start...

Things to check before you start:

- ✓ Ensure your base is ready – See page 4.
- ✓ Check all parts as listed in the parts lists.
- ✓ Read the instructions fully before starting work.
- ✓ Follow all the health and safety guidelines.

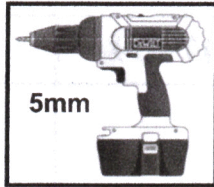

When you see the drill icon
Only ever drill through the first piece of framework which will be a pilot hole for the screw to attach the second piece of framework
The required drill bit size is shown with the icon.

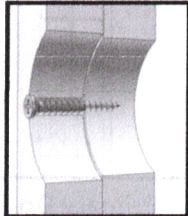
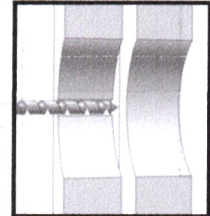

You will need:



- Hammer



- Spirit level



- Ladder

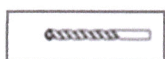

- 1mm + 5mm drill bit

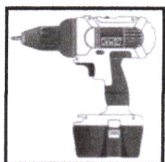

- Drill

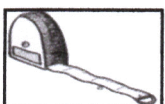

- Tape measure & Ruler

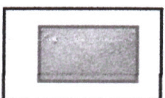

- Sand paper



- Gloves

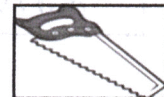

- Saw

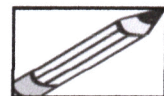

- Pencil



- Goggles

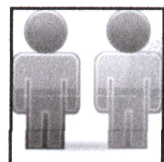

- A helper for some tasks



- Screwdriver

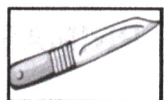

- Sharp knife

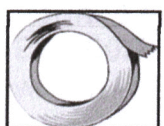

- Masking tape

Assembly instructions:

These instructions are for your safety. Please read through them thoroughly before use.
Treat all the parts before assembly – see page 5!

GB-IE The "Panel layout" is showing you how to position the panels.

The Back Plain Panels FIT INSIDE THE WINDOW AND PLAIN PANELS!

01

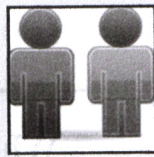
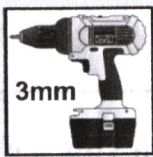
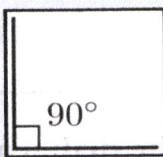

WINDOW AND PLAIN PANELS CAN BE SWAPPED

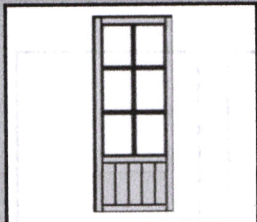

Primary Door (B0055-P)x01

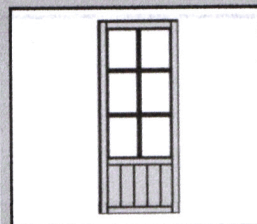

Secondary Door (B0055-S)x01

	A07909	A07909	A07909	A07909	
A07911	A07907	A07907	A07907	A07907	A07909
A07911					A07909
	A07910	A07910	A07910	A07909	

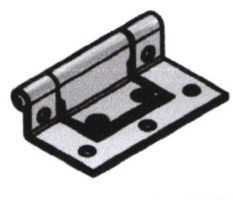

Storm Hinge 2.5" (A0013)x06

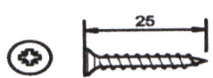

25mm Screws (A0032)x12

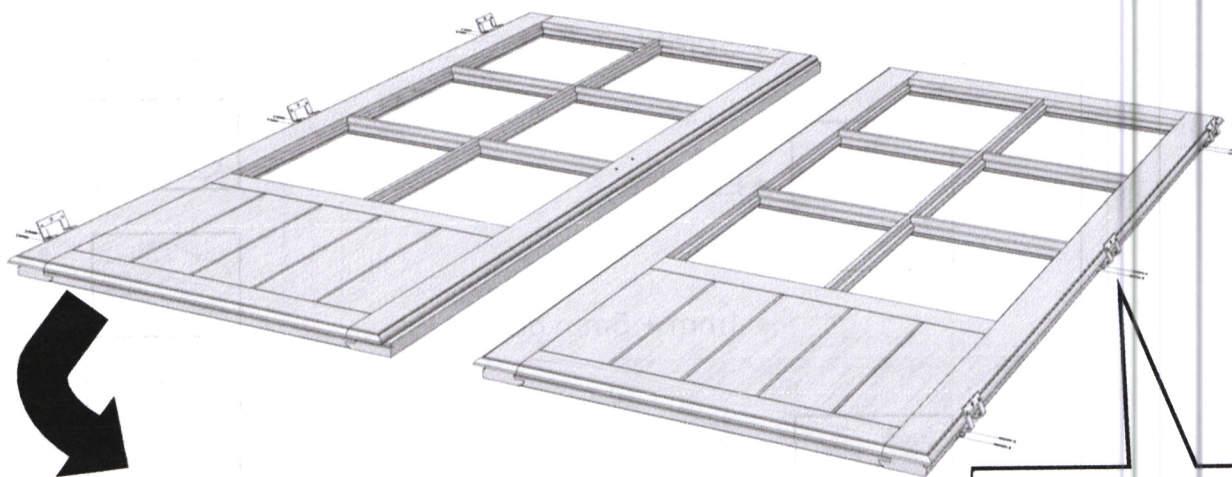

PRIMARY



SECONDARY

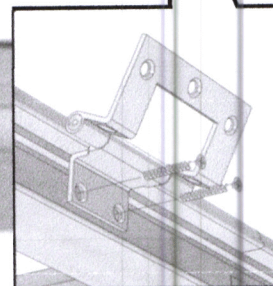

Fix the 2.5" Storm Hinges (A0013) to the Primary Door (B0055-P) and the Secondary Door (B0055-S) using 25mm Screws (A0032) as below. (Make sure to screw the two-hole part first).
Space them evenly.
Set them aside.

GB-IE

12

GB-IE

FIX TWO **Storm Hinges 2.5" (A0013)** to the top of the **Window Sash (B0033)** as below. Use 2x **25mm Screws (A0032)**. Space them equal distance from the edge. Use a helper to hang the window sashes within the **Window Panels 514 (A07911)** as below. Use one **25mm Screw (A0032)** per hinge first. Check that the window opens and closes correctly before screwing the rest of the screws into the hinges. **Tip:** Mark the holes first. Screw the **Casement Stay (A0038)** on the inside as below, using the **25mm Screws (A0032)**. Mark where the Stay Pins sit first before fixing to the framework.

02

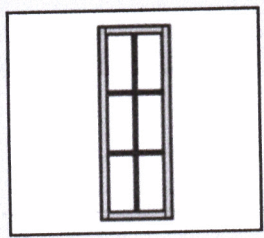

Window Sash (B0033)x02

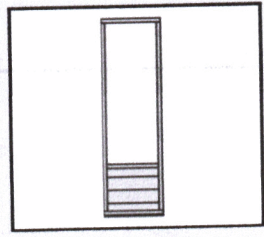

Window Panel 514 (A07911)x02

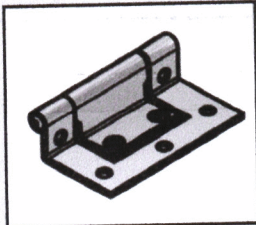

Storm Hinge 2.5" (A0013)x04

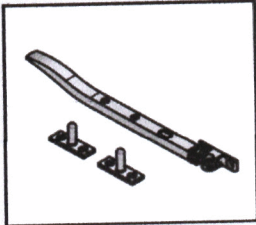

Casement Stay (A0038)x01

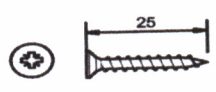

25mm Screws (A0032)x40

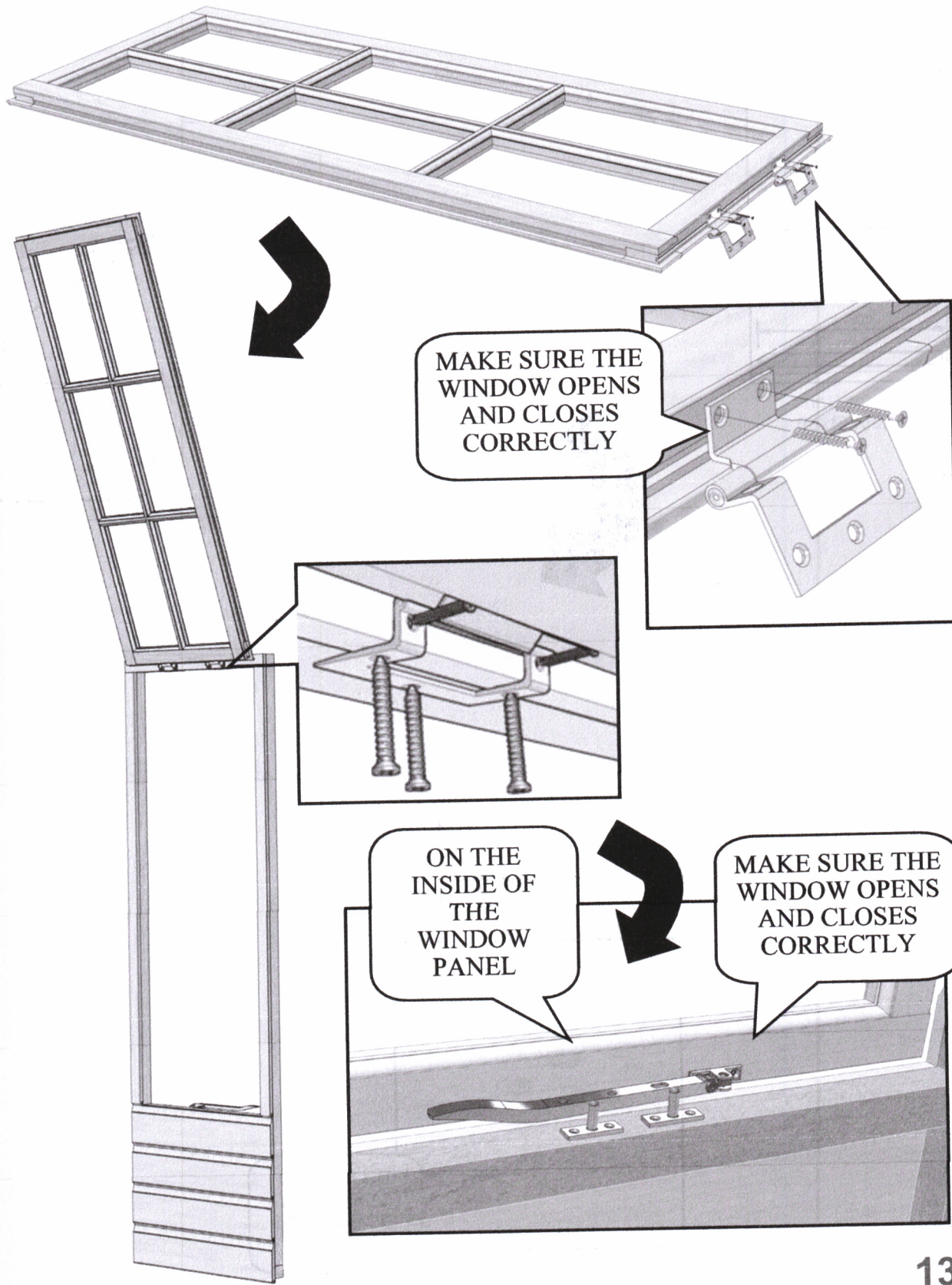
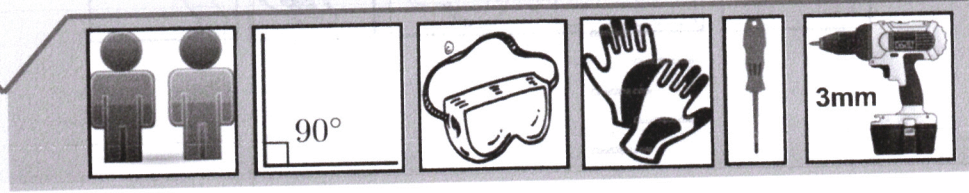

MAKE SURE THE WINDOW OPENS AND CLOSSES CORRECTLY

ON THE INSIDE OF THE WINDOW PANEL

MAKE SURE THE WINDOW OPENS AND CLOSSES CORRECTLY

GB-IE

Take two Floor Panels (A07907) and place onto your base as below. Align all the Joiners 34x46x230 (A0002) in between the floor bearers as below. Make sure the joiners stick out 115mm, so that they sit equally underneath the floor. Fix the joiners with 2x 40mm Nails (A0025) in each. Repeat this with the remaining Floor Panels (A07907). Make sure the nails go into the joiners!

03

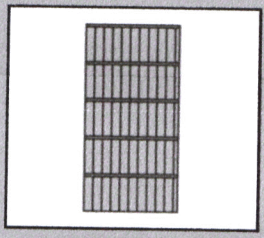
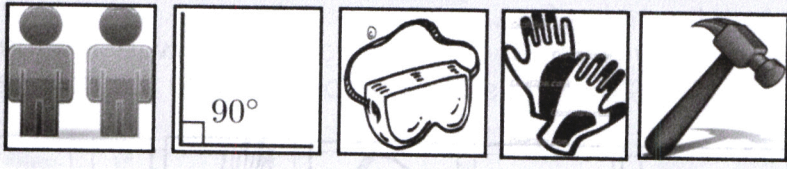

Floor Panel (A07907)x04

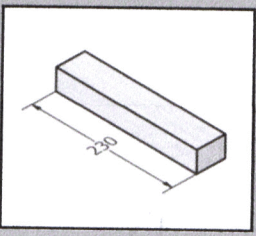

Joiner 34x46x230 (A0002)x15

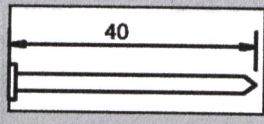

40mm Nails (A0025)x60

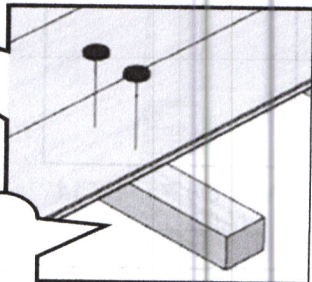
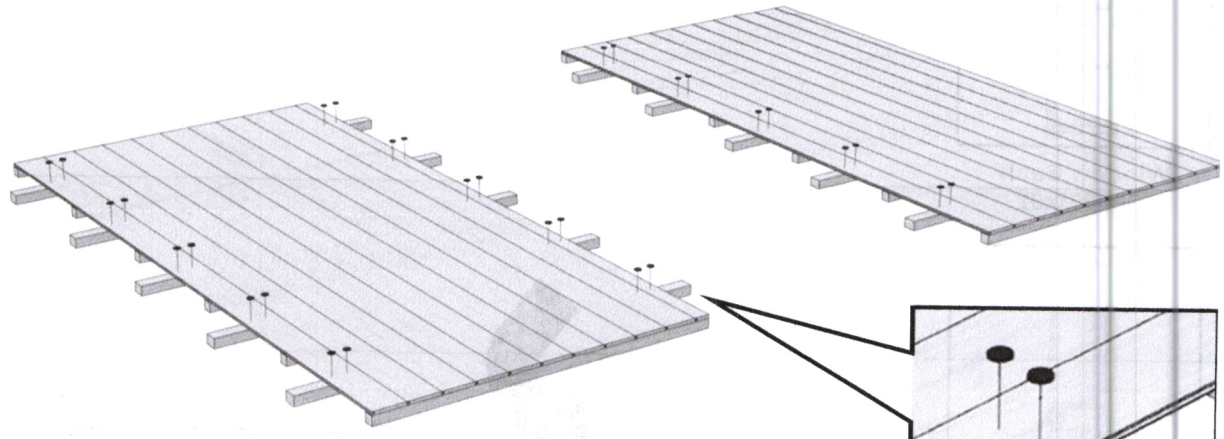

DO NOT FIX LESS THAN 20MM FROM THE EDGE

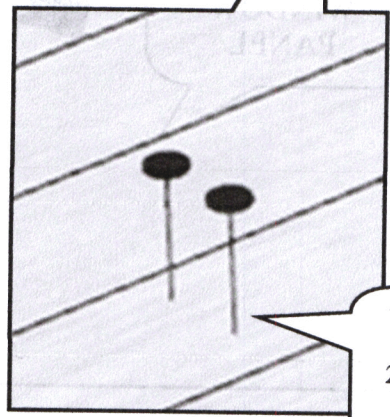
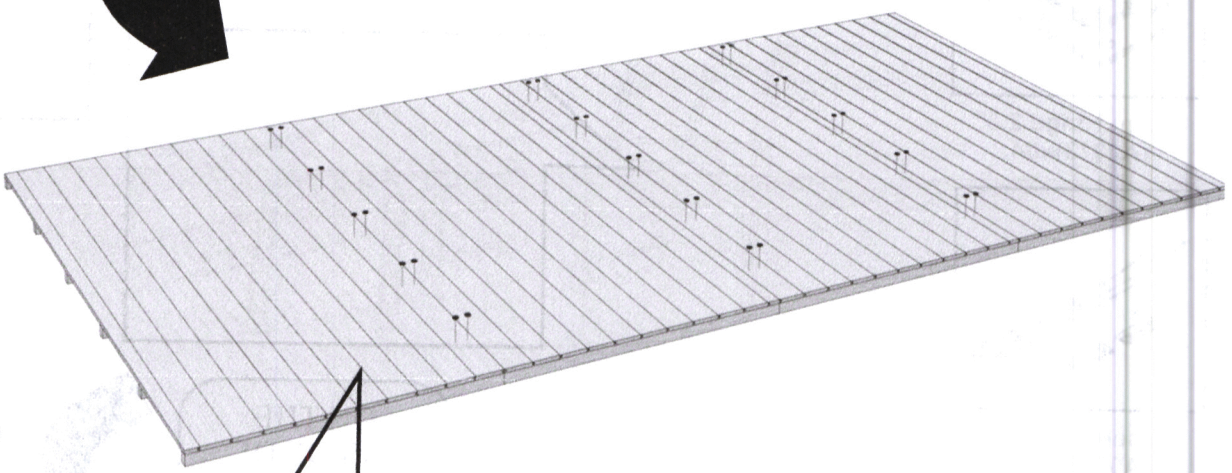

DO NOT FIX LESS THAN 20MM FROM THE EDGE

GB-IE

Drill one **Plain Panel (A07909)** with bottom holes only and another with left side drills. Drill a third **Plain Panel (A07909)** on both sides and another panel with holes down the right hand side, making sure the bottom holes in both panels are in line with the floor bearers. Place the second panel into the corner of the floor, making sure the cladding overlaps. Then push the third panel up to it and secure with 3x **60mm Screws (A0035)** using the pilot holes drilled. Push the first and fourth panels up to the previous and secure with 3x **60mm Screws (A0035)** in each, using the pilot holes drilled.

04

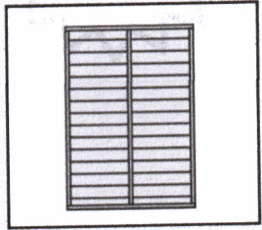

Plain Panel (A07909)x04

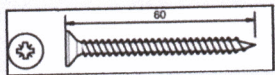

60mm Screws (A0035)x09

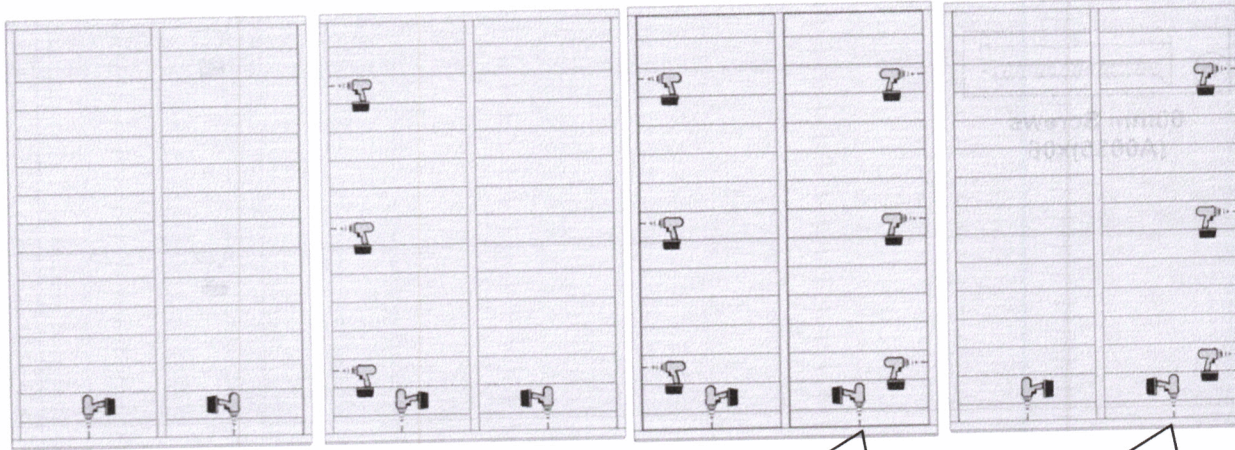
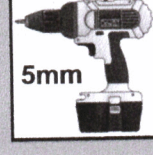
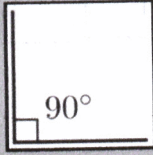
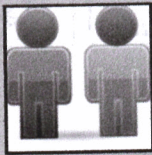

In line with Floor Bearers

In line with Floor Bearers

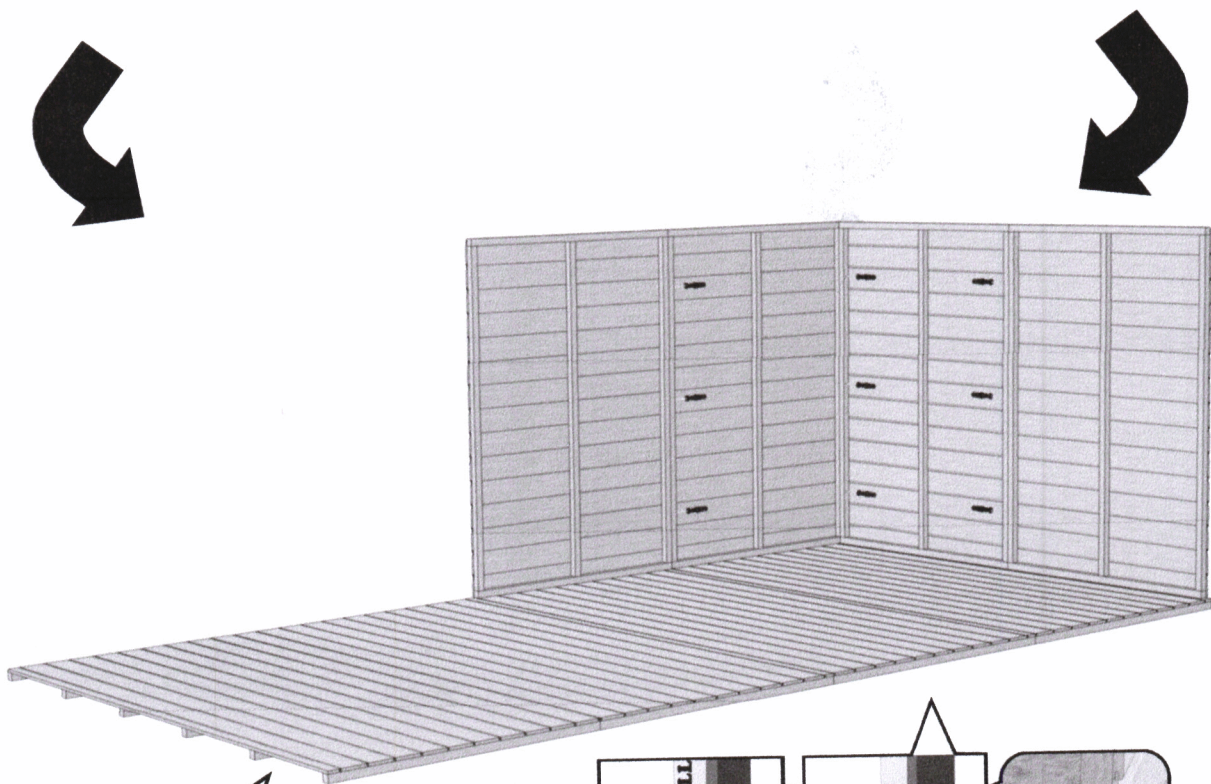

DO NOT
FIX WALLS TO
FLOOR
UNTIL ASKED

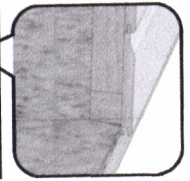
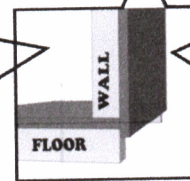
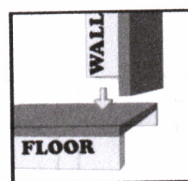

Drill two more **Plain Panels (A07909)** as below.
Place the panels onto the floor as below, making sure the cladding overlaps.
Secure the panels with 3x **60mm Screws (A0035)** using the pilot holes drilled in the middle plain panel as below.

05

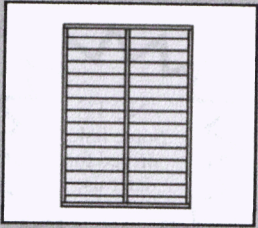

Plain Panel (A07909)x02

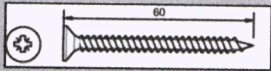

60mm Screws (A0035)x06

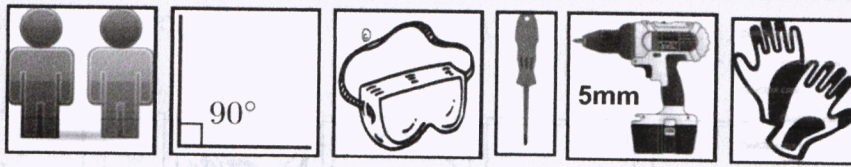

NOTE
Some holes drilled for later use

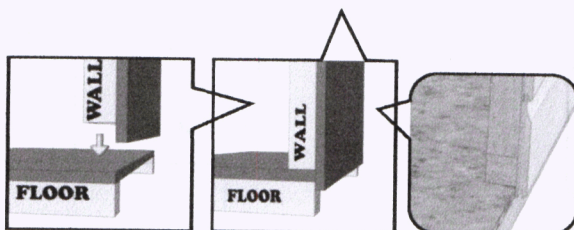
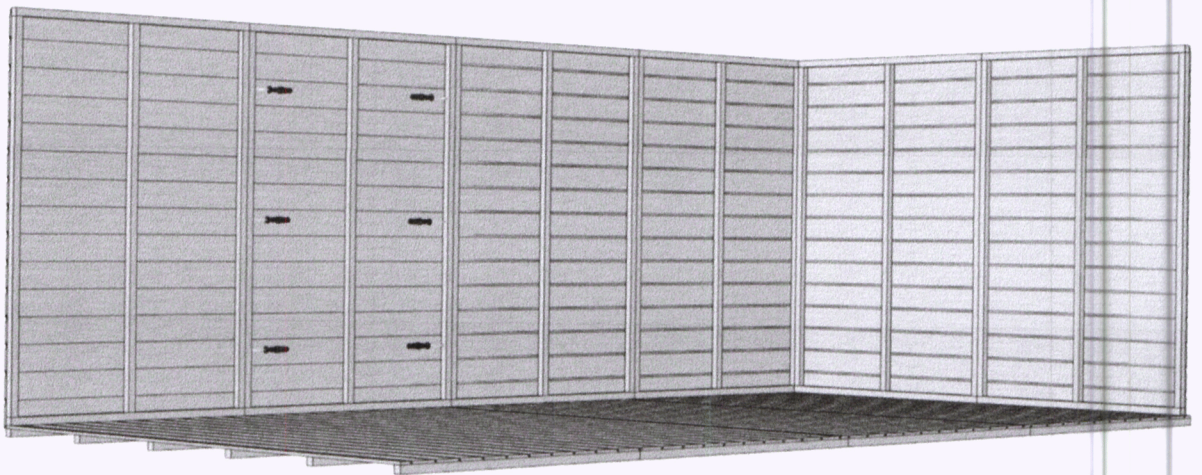
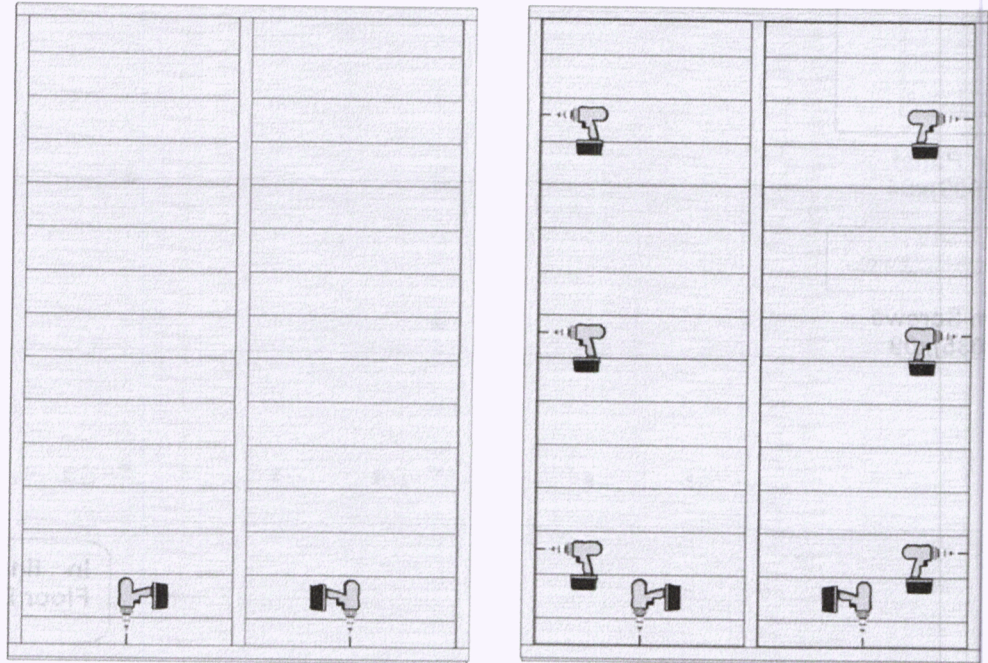

DO NOT FIX WALLS TO FLOOR UNTIL ASKED

GB-IE

Drill the last **Plain Panel (A07909)** as below.

Drill the three **Window Panel (A07910)** as below.

Place the plain panel into the corner of the floor and secure with 3x **60mm Screws (A0035)** using the pilot holes in the previous plain panel.

Place the window panels onto the floor and secure with 3x **60mm Screws (A0035)** using the pilot holes drilled in the middle window panel and end plain panel below.

06

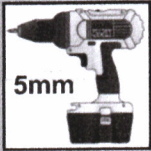
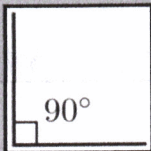

NOTE
Some holes drilled for later use

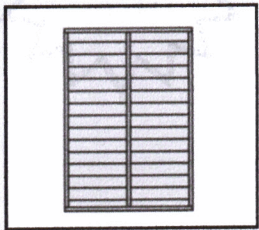

Plain Panel (A07909)x01

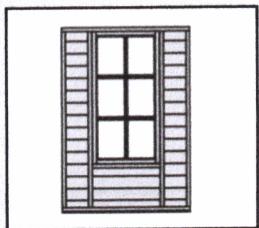

Window Panel (A07910)x03

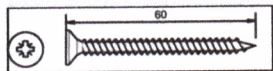

60mm Screws (A0035)x12

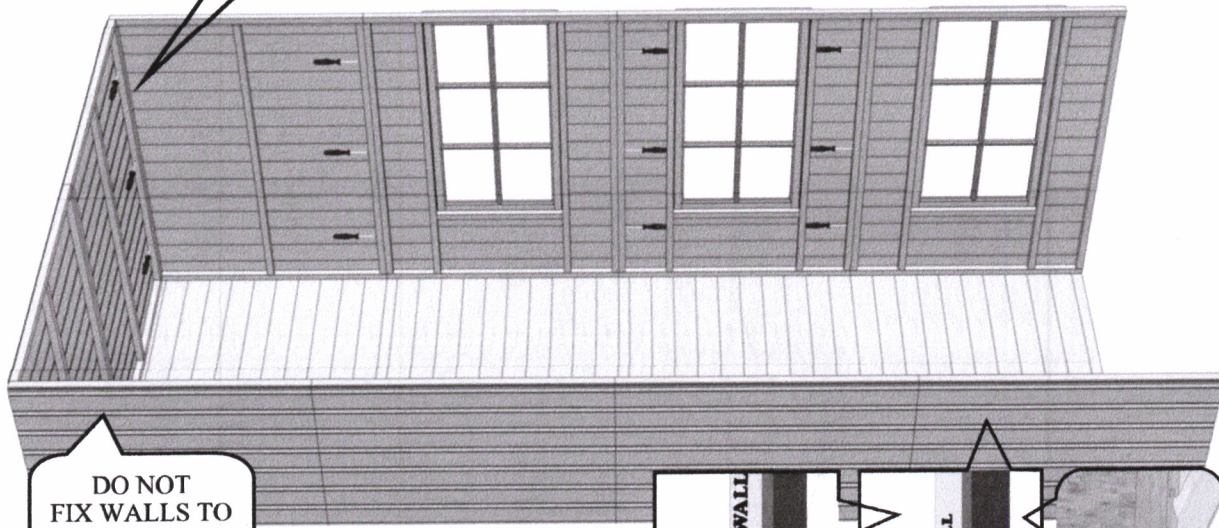
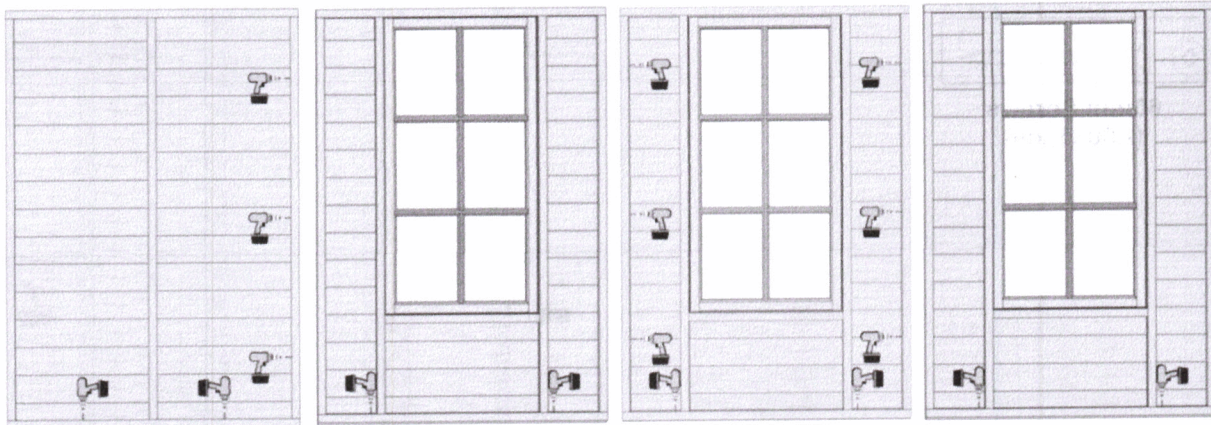

DO NOT
FIX WALLS TO
FLOOR
UNTIL ASKED

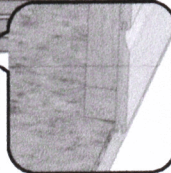
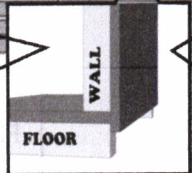
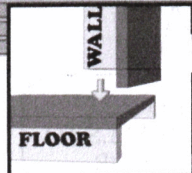

Drill the **Window Panels (Step 02)** as below.
Place onto your building and fix with **3x 60mm Screws (A0035)** using the pilot holes drilled.

07

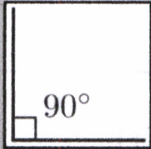
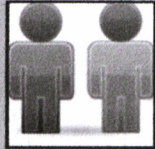

NOTE
Some holes drilled for later use

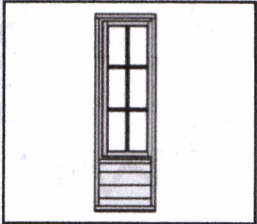

Window Panel 514 (Step 02)x02

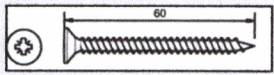

60mm Screws (A0035)x06

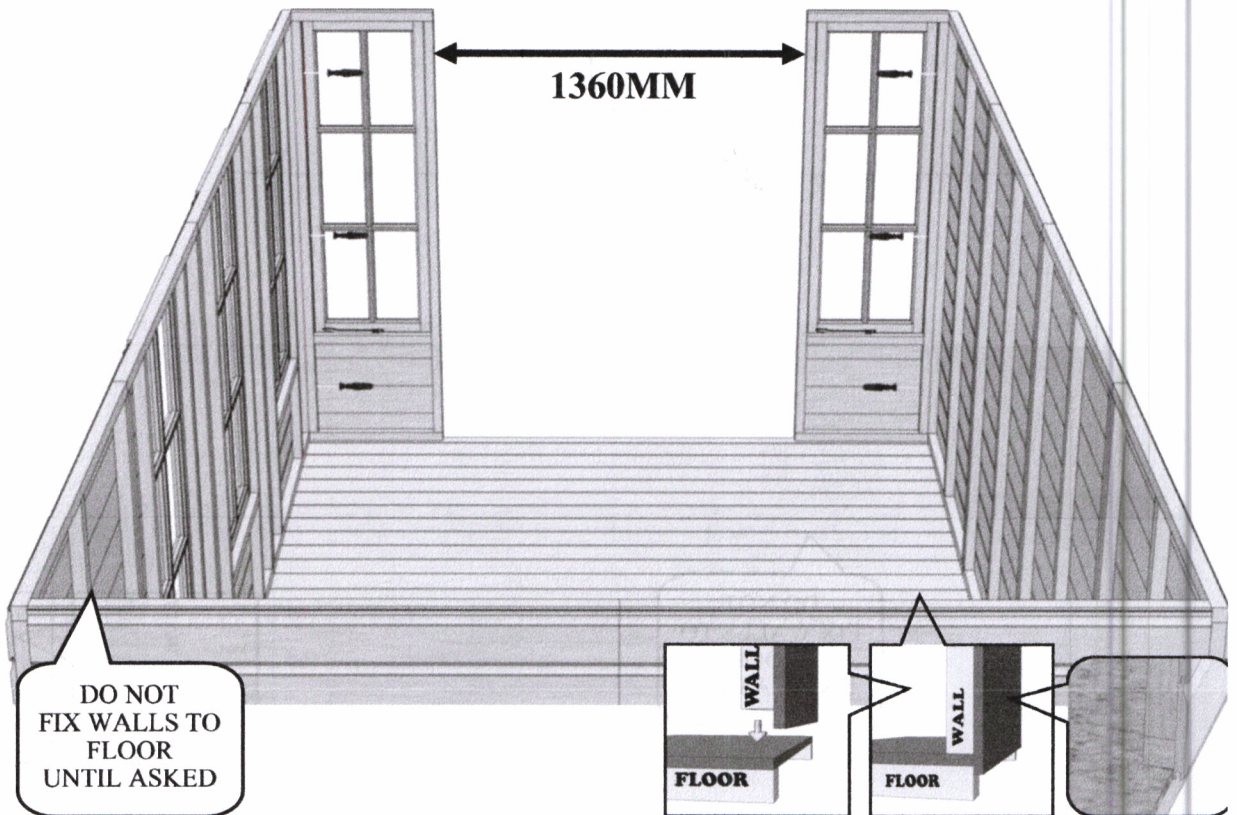
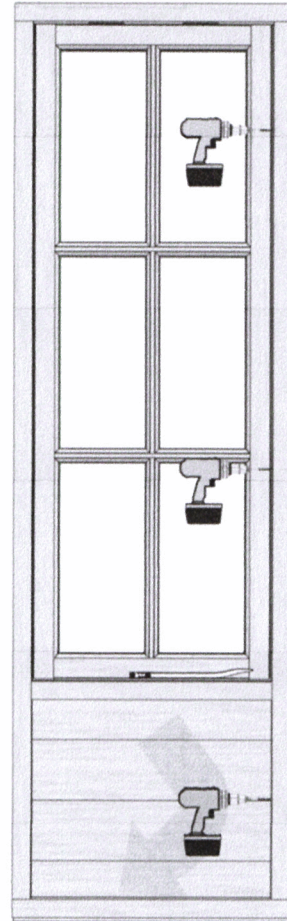
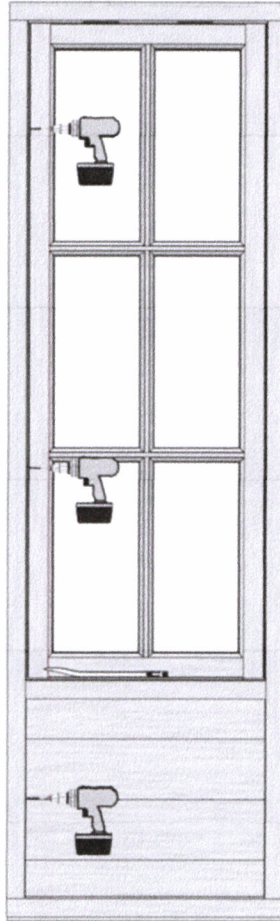

**DO NOT
FIX WALLS TO
FLOOR
UNTIL ASKED**

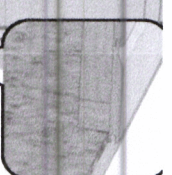
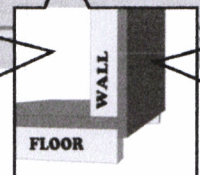
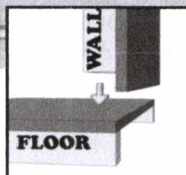

GB-IE Lay the **Truss Frames (A07914-1)** and **Truss Braces (A07914-2)** on a flat, clean surface. Position them together to create the truss as below. Use the gables as a guide if need be. Secure the truss together using **2x 60mm Screws (A0035)** in each side.

08

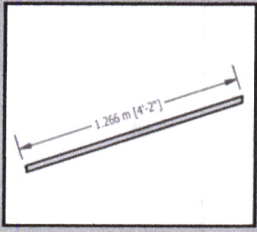

Truss Frame (A07914-1)x06

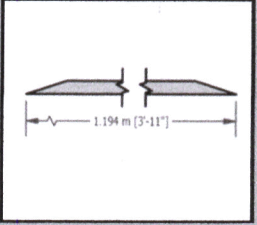

Truss Brace (A07914-2)x06

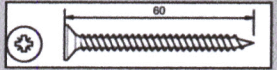

60mm Screws (A0035)x18

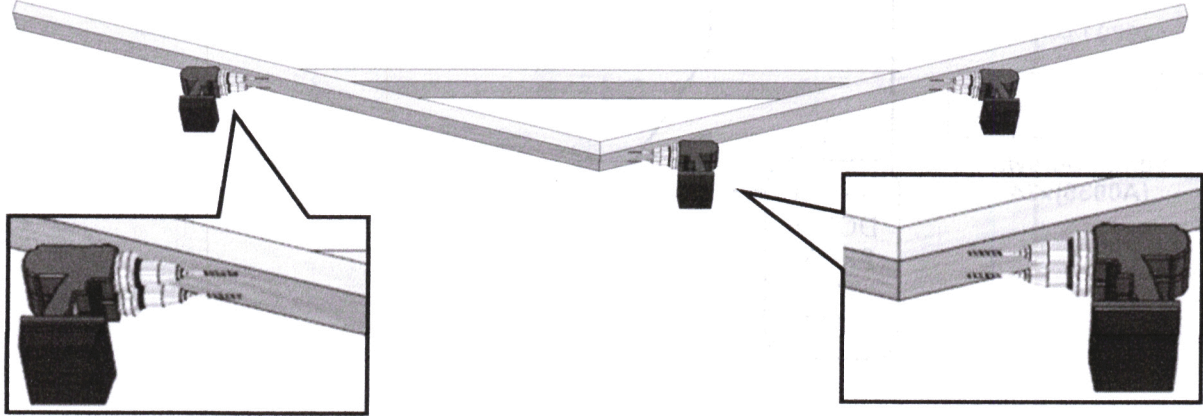
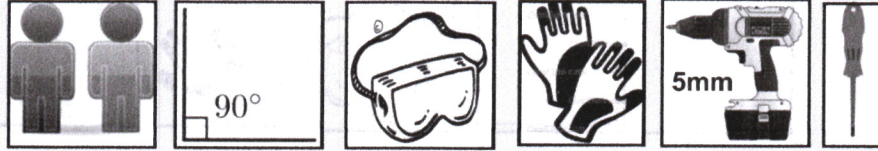

GB-IE Place the **Gables (A07912)** onto the building that the frameworks are flush. Secure the back gable through the plain panels using **2x 60mm Screws (A0035)** per panel. Secure the front gable with **1x 60mm Screw (A0035)** through the window panels and **1x 60mm Screw (A0035)** through the top of the gable as below.

09

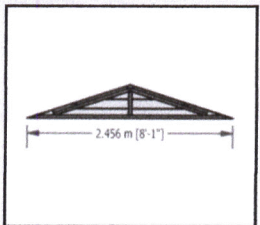

Gable (A07912)x02

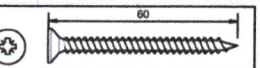

60mm Screws (A0035)x08

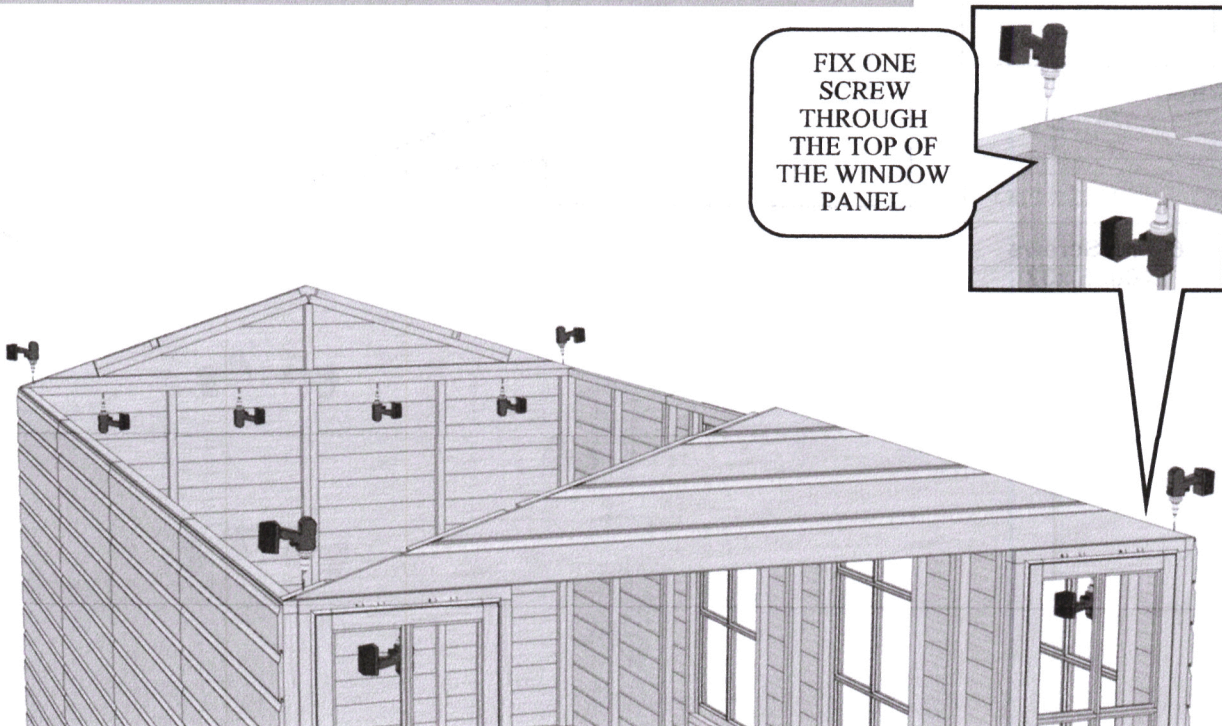
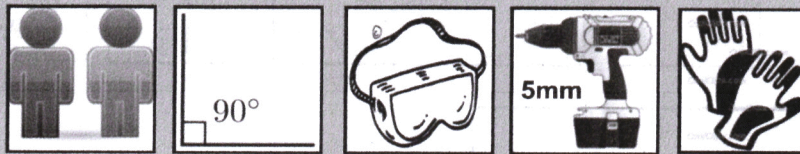

GB-IE **FIX THE TRUSS BLOCKS (A07914-3) TO THE WALL PANELS 60MM DOWN FROM THE TOP OF THE WALL.**
 Place the trusses from **step 08** onto the blocks and secure with 2x **60mm Screw (A0035)** in each side, screwing through the top.

10

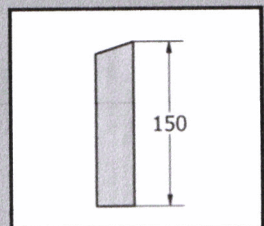

Truss Block (A07914-3)x06

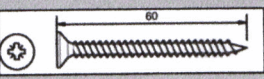

60mm Screws (A0035)x24

90°

60MM DOWN FROM THE TOP

GB-IE Place the **Roof Bearers 34x34 (A07913)** into the gable slots as below and onto the trusses. Using 1x **60mm Screw (A0035)** in each end, secure the roof bearers to the gables and truss.

11

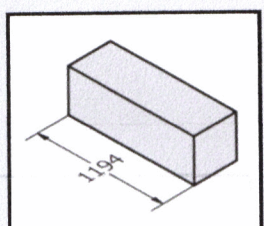

Roof Bearer 34x34 (A07913)x16

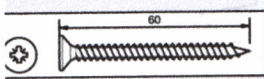

60mm Screws (A0035)x32

90°

20

Lay two **Roof Panels (A07908)** flat and opposite as below, making sure the overhang is facing each other. Measure, mark and cut **42mm** off the top bar as below. Place them aside.
Note: Make sure the panels are the opposite of each other.
 Fix the **Roof Overhang 34x34 (A0011)** to the **Extension Roof Panels (A07917)** as below. Make sure the roof panels are the opposite to each other. Secure with 2x **40mm Nails (A0025)** in each. Then carefully turn over the panels and lay them opposite to each other. Measure and mark a **46mm** gap on the long bar of the roof panel, straight after the roof overhang bar. Carefully cut this gap out.

12

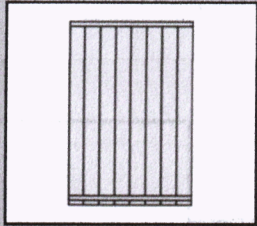
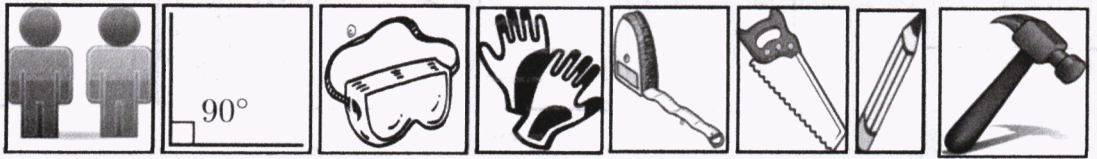

Roof Panel (A07908)x02

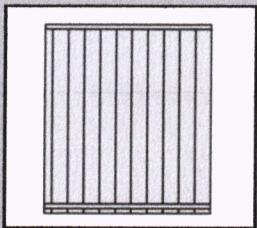

Extension Roof Panel (A07917)x02

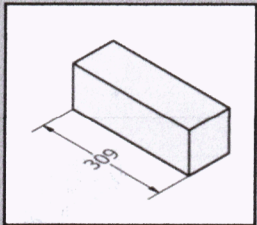

Roof Overhang 34x34 (A0011)x02

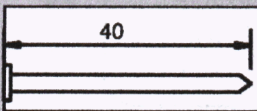

40mm Nails (A0025)x04

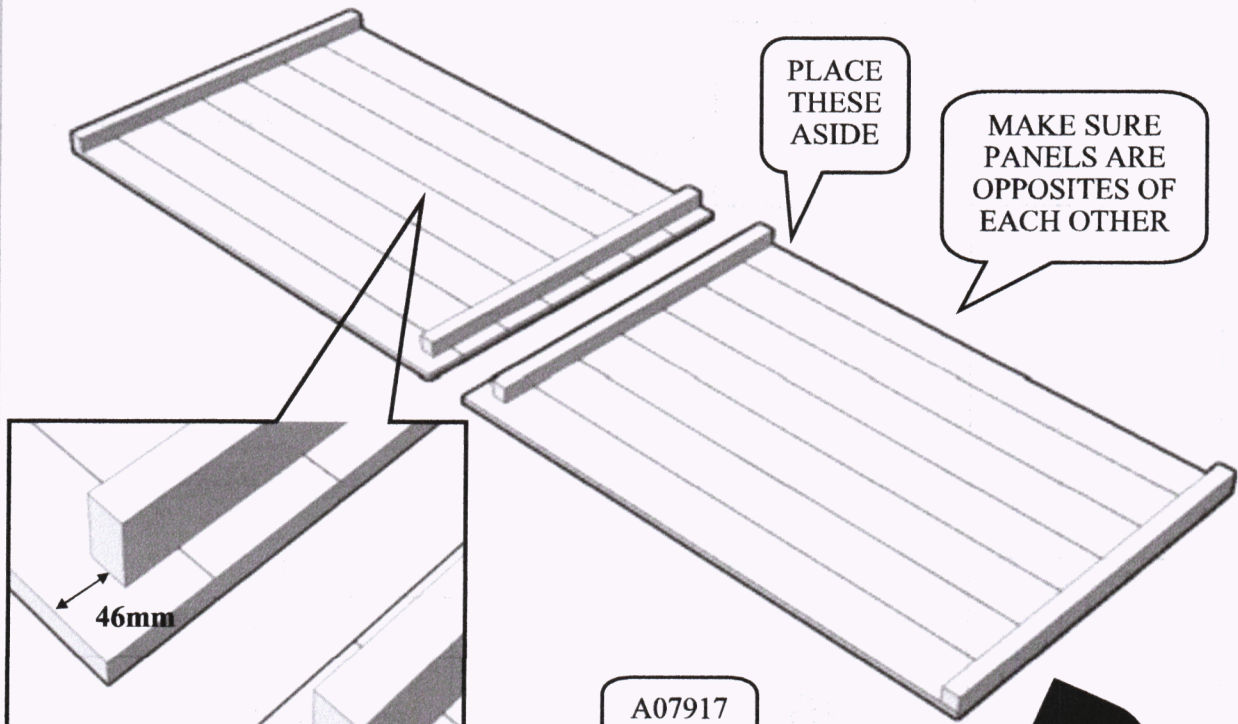

A07917 PANELS

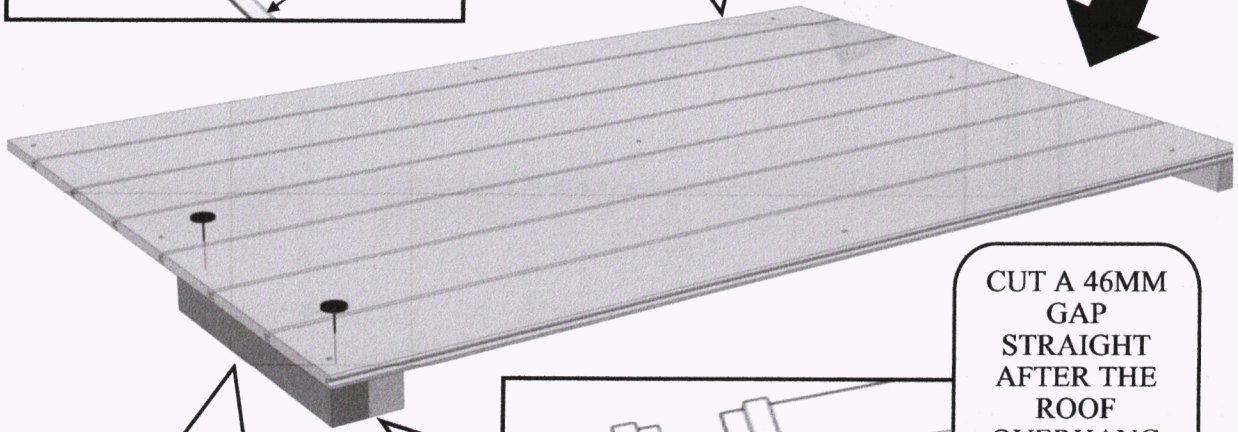

MAKE SURE PANELS ARE OPPOSITES OF EACH OTHER

CUT A 46MM GAP STRAIGHT AFTER THE ROOF OVERHANG 34X34 (A0011)

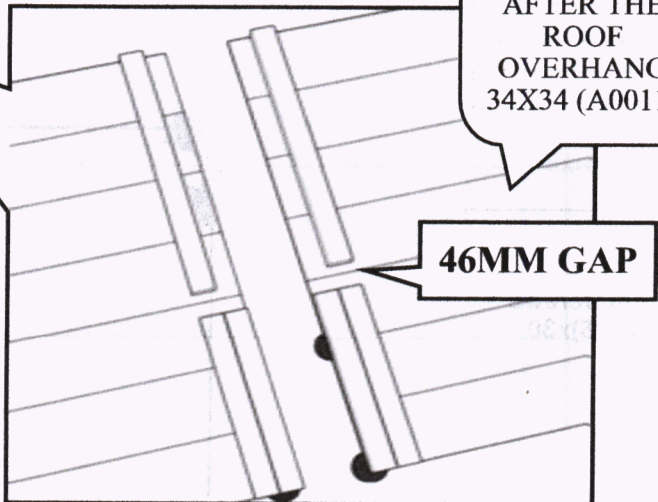

46MM GAP

Place the two **Roof Panels (Step 12)** onto the back of your building as below.
Make sure the cut out bar is flush with the gable cladding. Fix the panel down with 3x **40mm Nails (A0025)** in each roof bearer and the wall panels below; repeat with four new **Roof Panels (A07909)**.

Then place two **Extension Roof Panels (A07917)** onto your building and secure as before.
Then place the **Extension Roof Panels (Step 12)**, making sure the roof overhang is to the front.
Secure with 2x **40mm Nails (A0025)** in each roof bearer and wall panel.
From the inside, use 3x **60mm Screws (A0035)** to fix the top of the panels to the bearers.

13

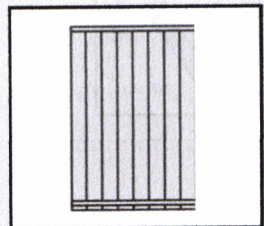
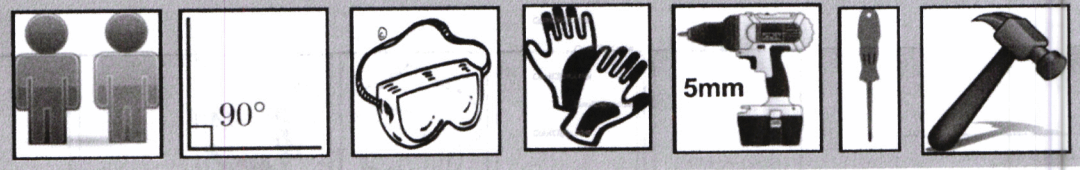

Roof Panel (A07908)x02 Step 12

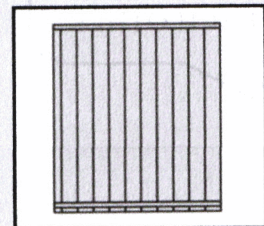

Roof Panel (A07917)x02 Step 12

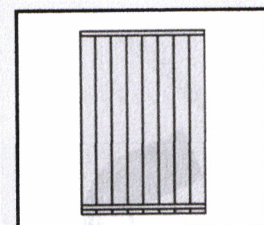

Roof Panel (A07908)x04

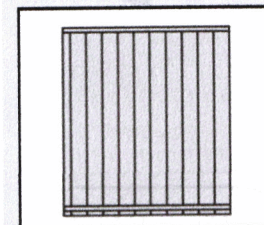

Extension Roof Panel (A07917)x02

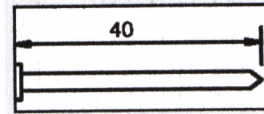

40mm Nails (A0025)x84

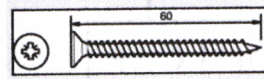

60mm Screws (A0035)x30

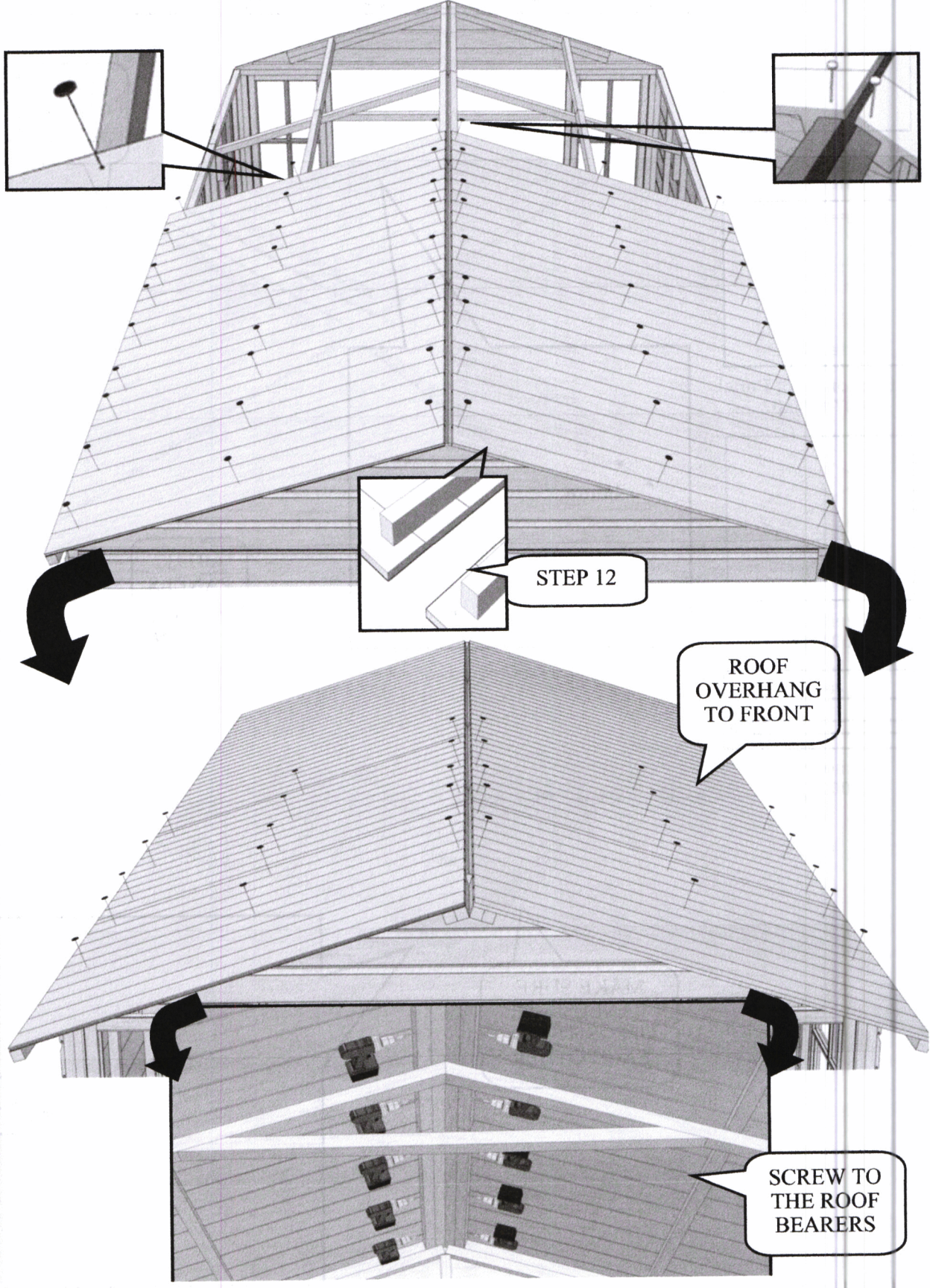

GB-IE

Hang the doors (**Step 01**) within the door aperture as below. Fix the hinges to the posts as below using **25mm Screws (A0032)**.

TIP: Use packing under the door to level them out. Make sure that the primary door is the door that opens first.

14

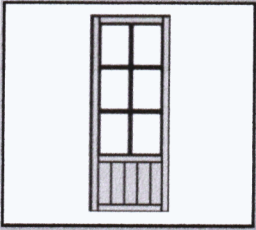

Primary Door (B0055-P)x01

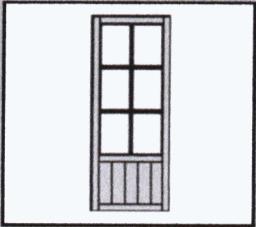

Secondary Door (B0055-S)x01

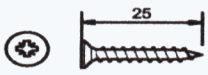

25mm Screws (A0032)x30

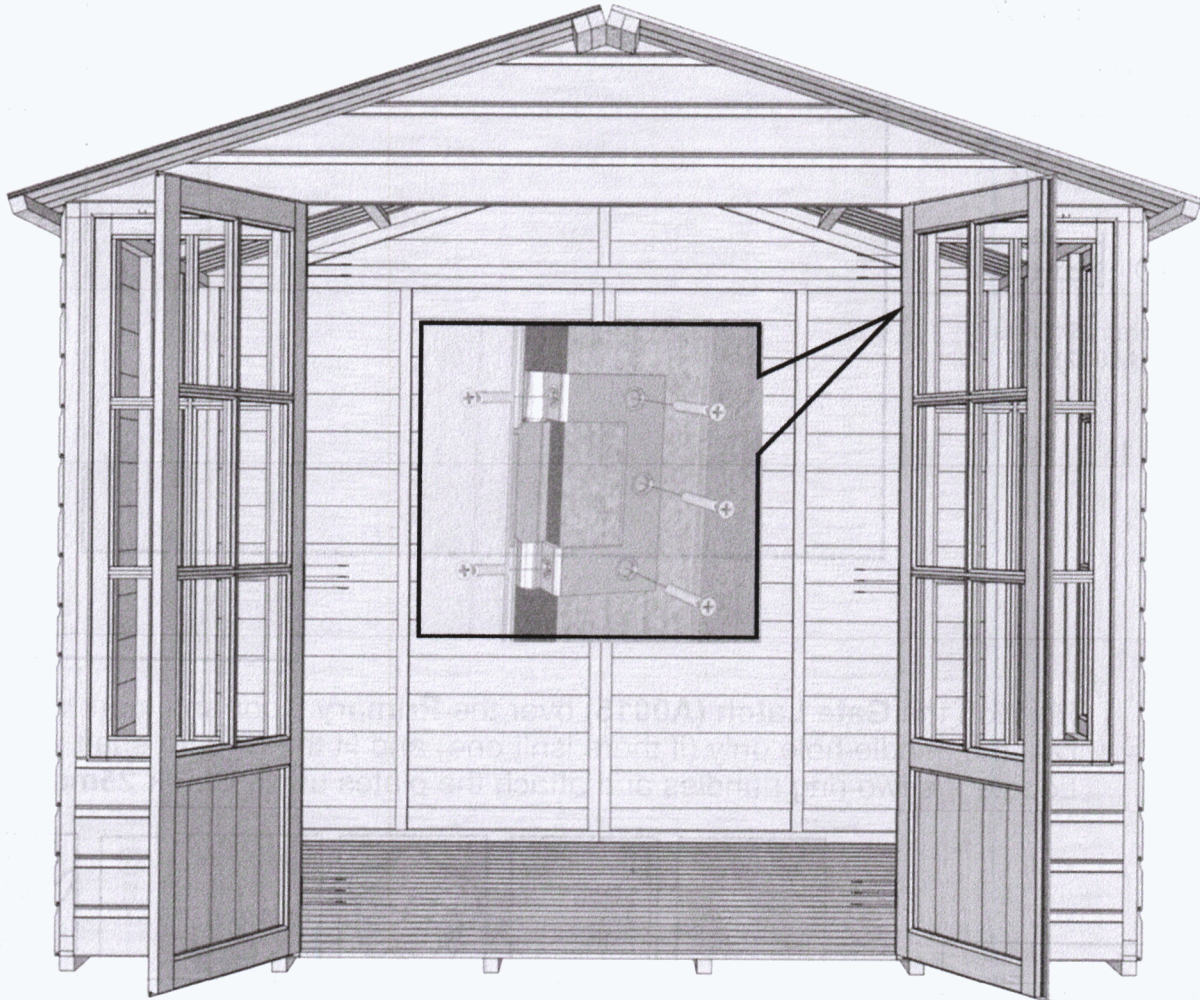

Make sure your building is square and true.

GB-IE

Fix the walls to the floor with 1x **60mm Screws (A0035)** in each panel, using the pilot holes drilled previously.

15

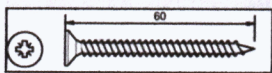
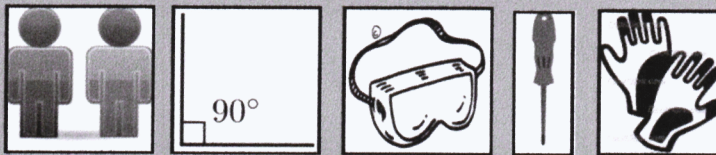

60mm Screws (A0035)x20

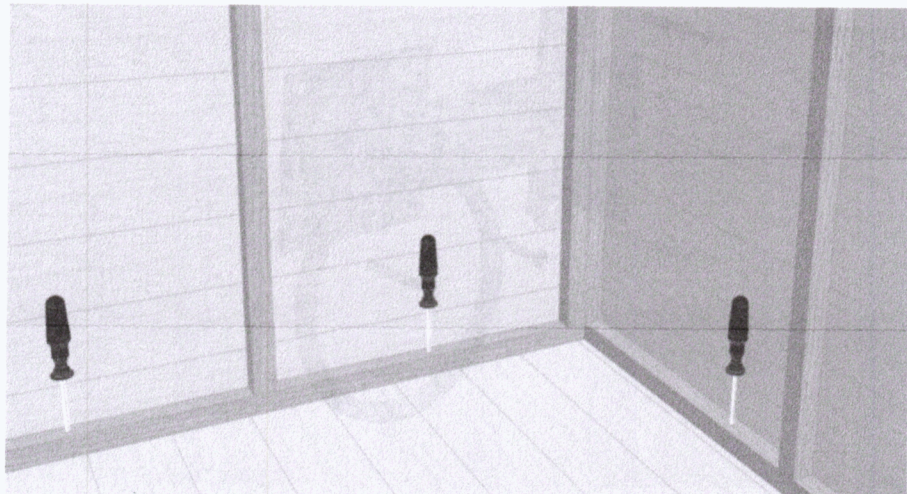

GB-IE

mark and drill a hole where the bolt will go into the framework.
Screw the **Barrel Bolts (A0014)** to the secondary door as below.
Make sure everything works before tightening screws.
Fix with **25mm Screws (A0032)**. Repeat with top bolt.

16

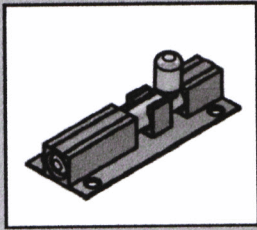
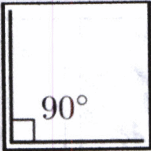
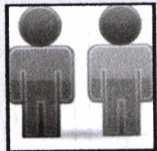

Barrel Bolt
(A0014)x02

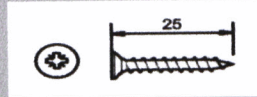

25mm Screws
(A0032)x08

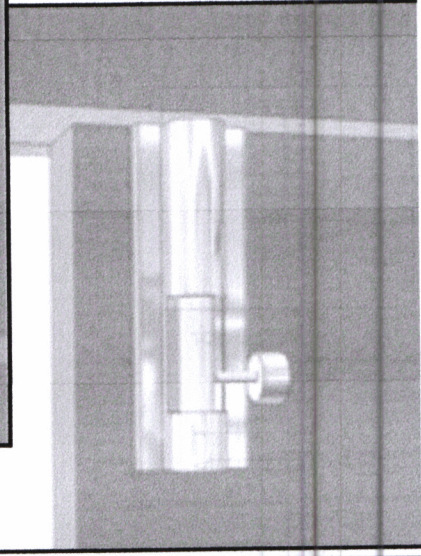
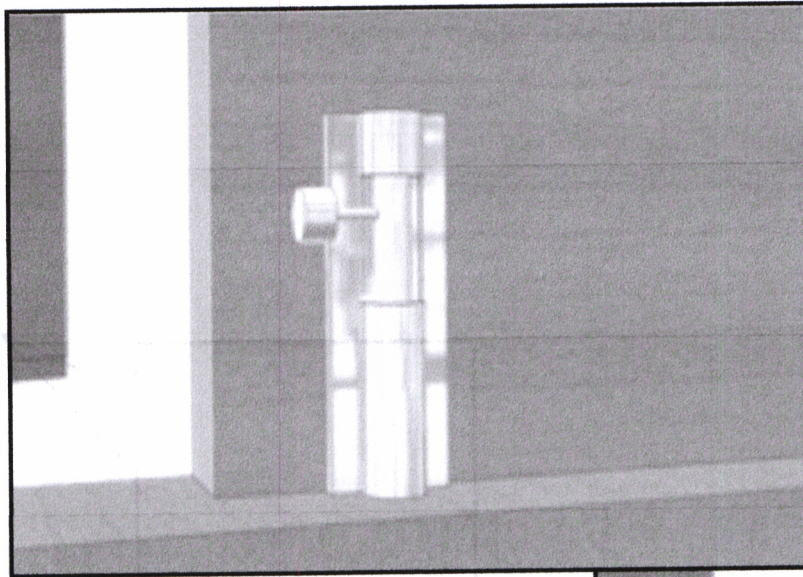

GB-IE

Position the **Gate Latch (A0015)** over the **Primary Door** and mark where the holes sit.
Drill the middle hole only (if there isn't one) and fit the Square shaft into the hole.
Locate the two ring handles and attach the plates using **Black 25mm Screws (A0031)**.

17

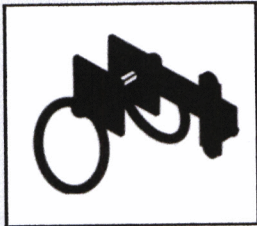
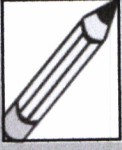
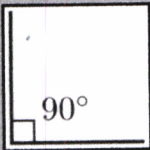

Gate Latch
(A0015)x01



Black 25mm Screws
(A0031)x10

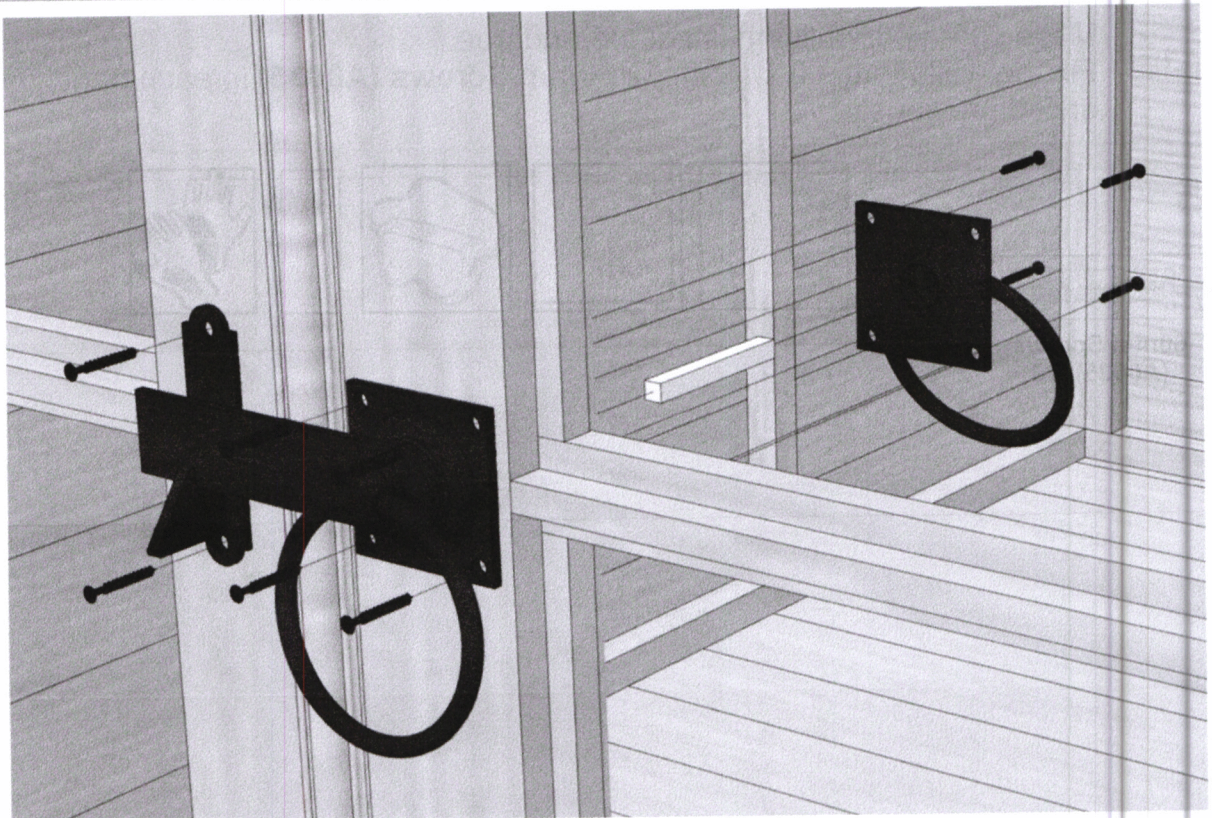

24

GB-IE Fix the **Coverstrips 12x46x1720 (A0016)** to the corners and panel joins of your building as below.
Fix with 4x **40mm Nails (A0025)** in each.

18

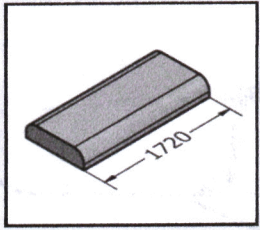
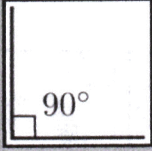

Coverstrip 12x46x1720 (A0016)x11

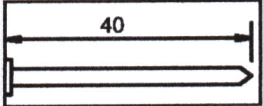

40mm Nails (A0025)x44

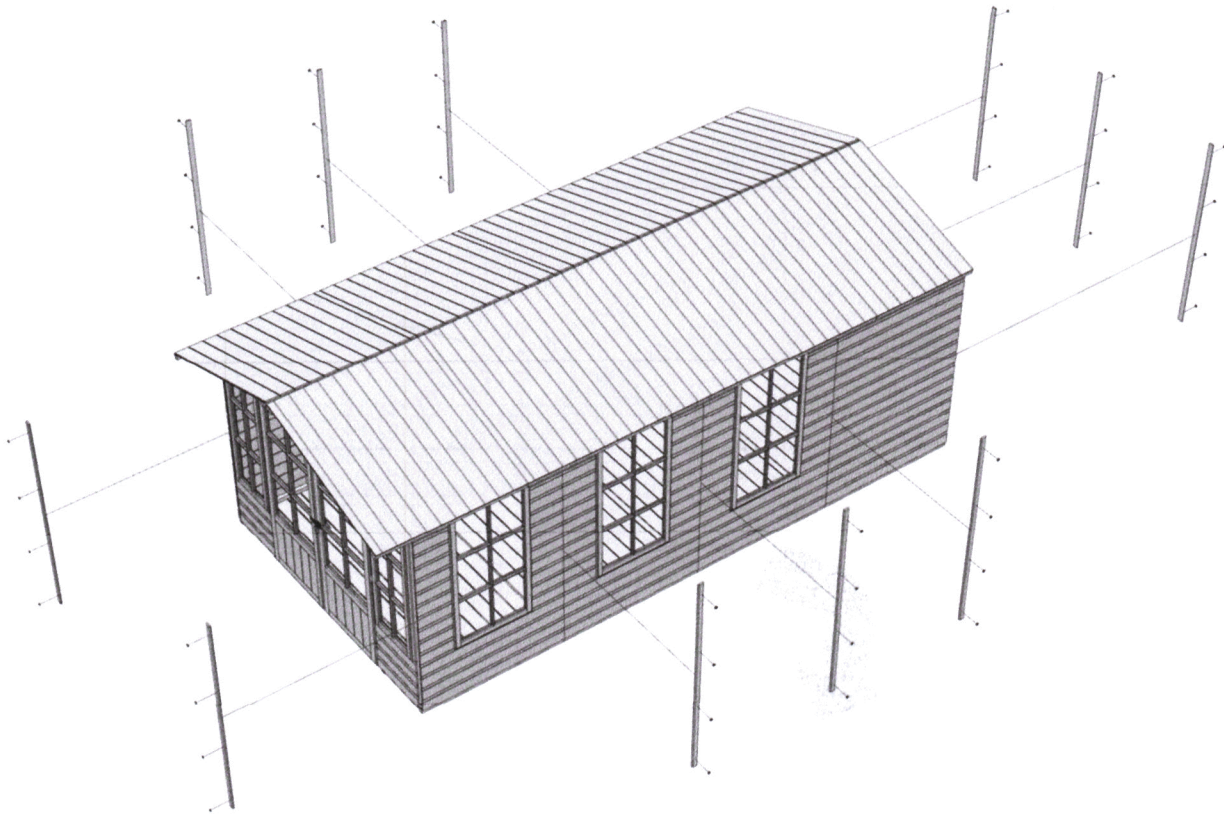

GB-IE

3 strips of Felt 4m (A3692) have been supplied.

Fit the first two strips to your building as below. Make sure there is an even overhang either side, pull tight and secure with **13mm Felt Nails (A0023)** approximately **100mm** apart. Trim any excess.

Fit the last strip, overlapping the first two strips as below. Pull tight and secure as before.

19

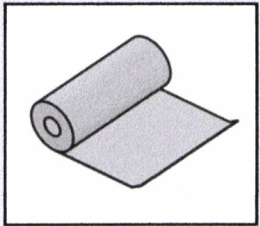
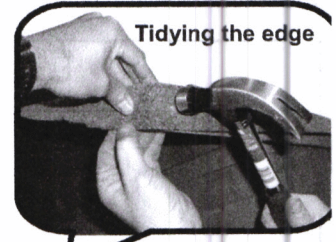
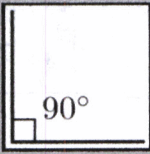

Felt Strip 5.3m
(A4506)x03

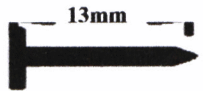

13mm Felt Nails
(A0023)x250

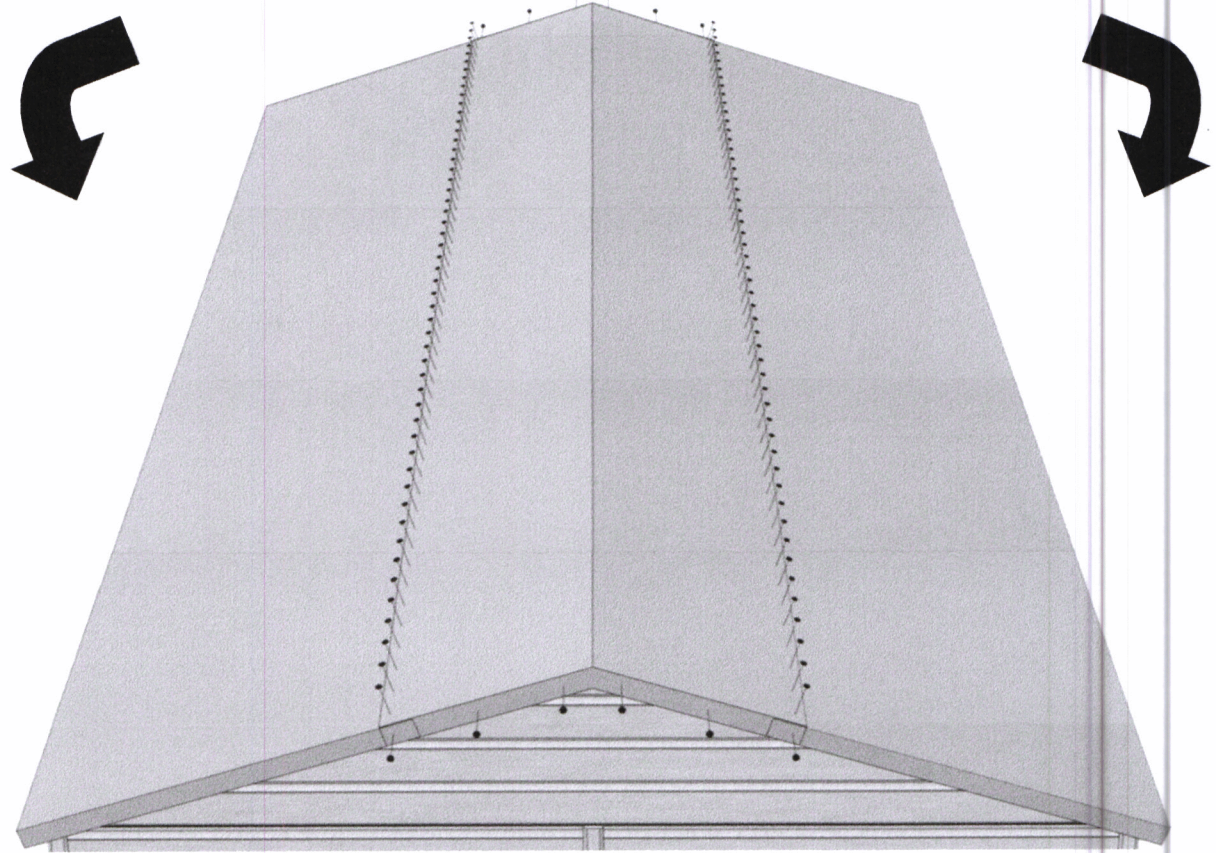
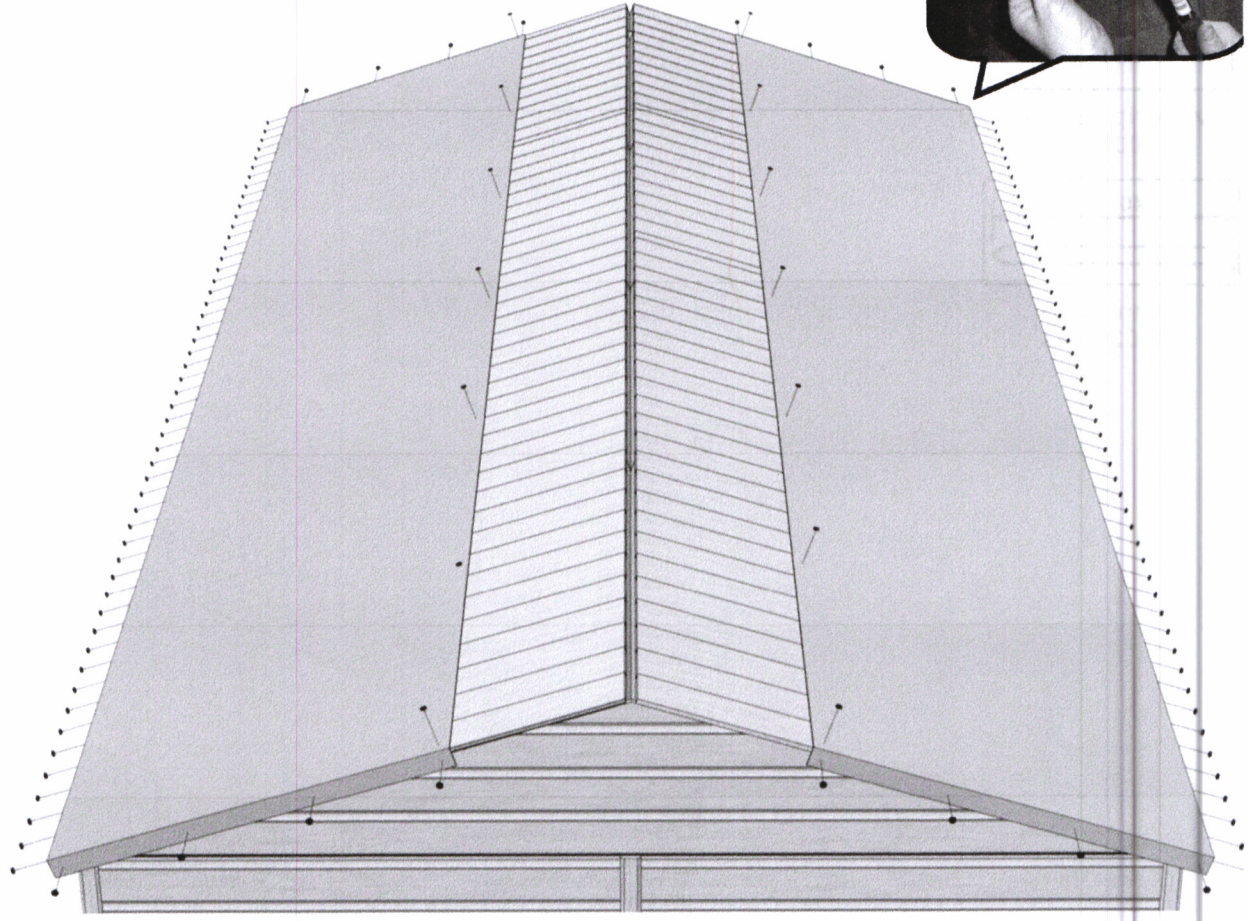

26

GB-IE Fix the Fascia 12x70x1415 (A07915) to your building as below.
Fix with 3x 40mm Nails (A0025) in each.
Fix the Diamonds (A0019) over the fascia joins and secure with 2x 40mm Nails (A0025).

20

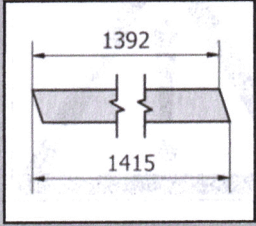
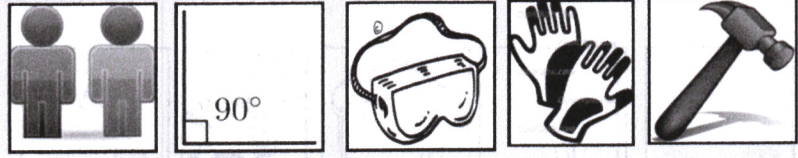

Fascia 12x70x1415 (A07915)x04

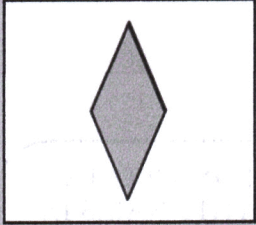

Diamond (A0019)x02

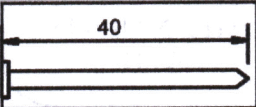

40mm Nails (A0025)x16

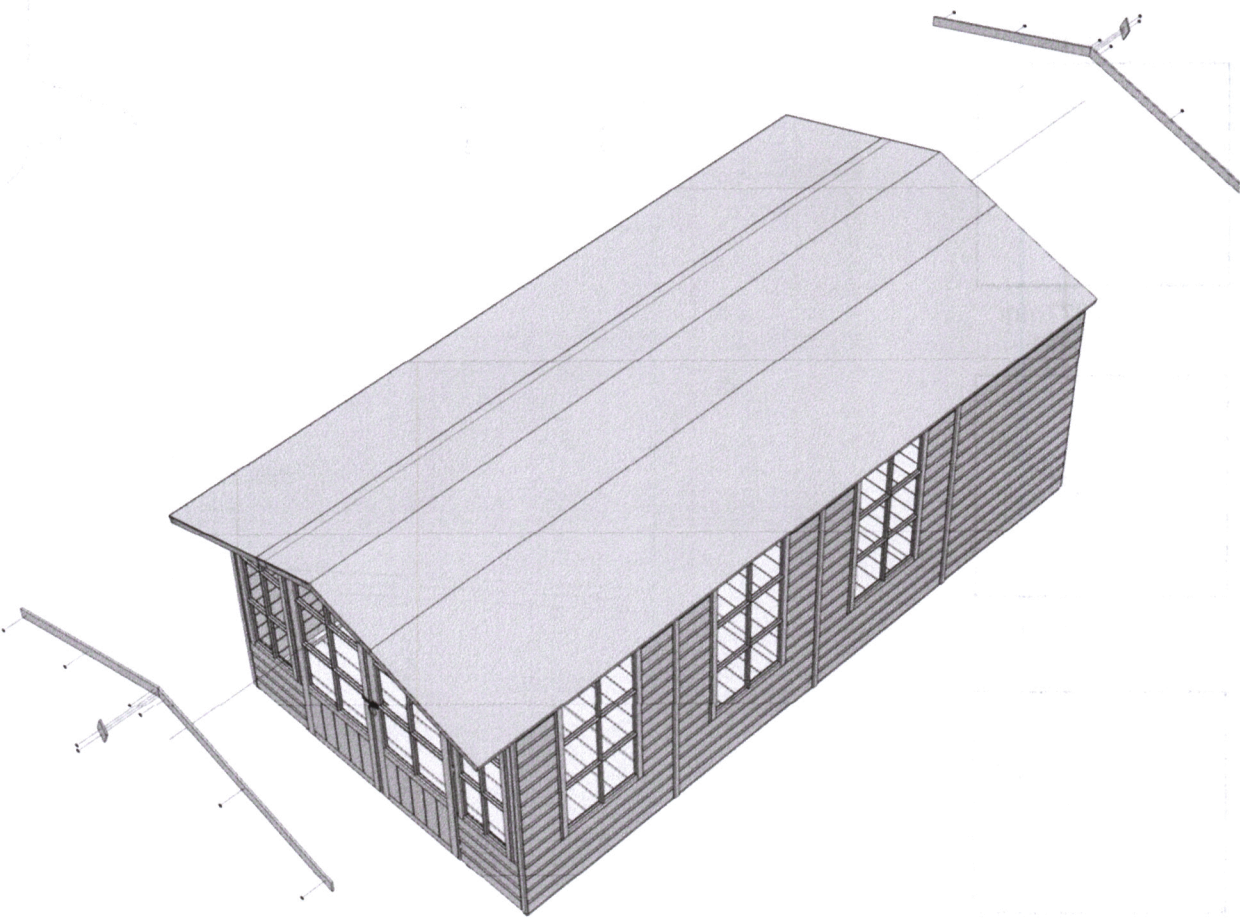



Using a helper, hold the glass in place whilst you fit the beading. Fit the **Glass 268x373 (A0020)**, **2x Beading 377mm (A0021)** and **Beading 270mm (A0022)** to the side window and doors. Fix the **Glass 175x373 (A1173)**, **Beading 377mm (A0021)** and **Beading 177mm (A3418)** to the front windows. Fix all beading with **16mm Panel Pins (A0024)** as below.



21

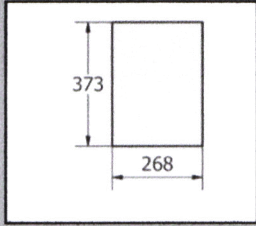
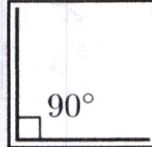

Glass 268x373 (A0020)x30

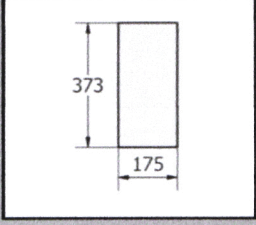

Glass 175x373 (A1173)x12

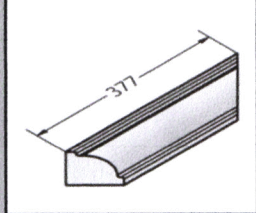

Beading 377mm (A0021)x84

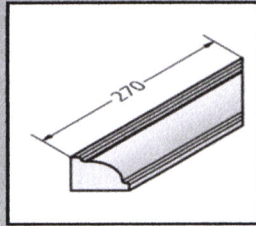

Beading 270mm (A0022)x60

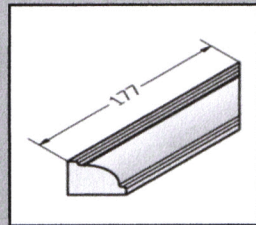

Beading 177mm (A3418)x24

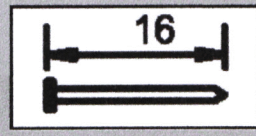

16mm Panel Pins (A0024)x420

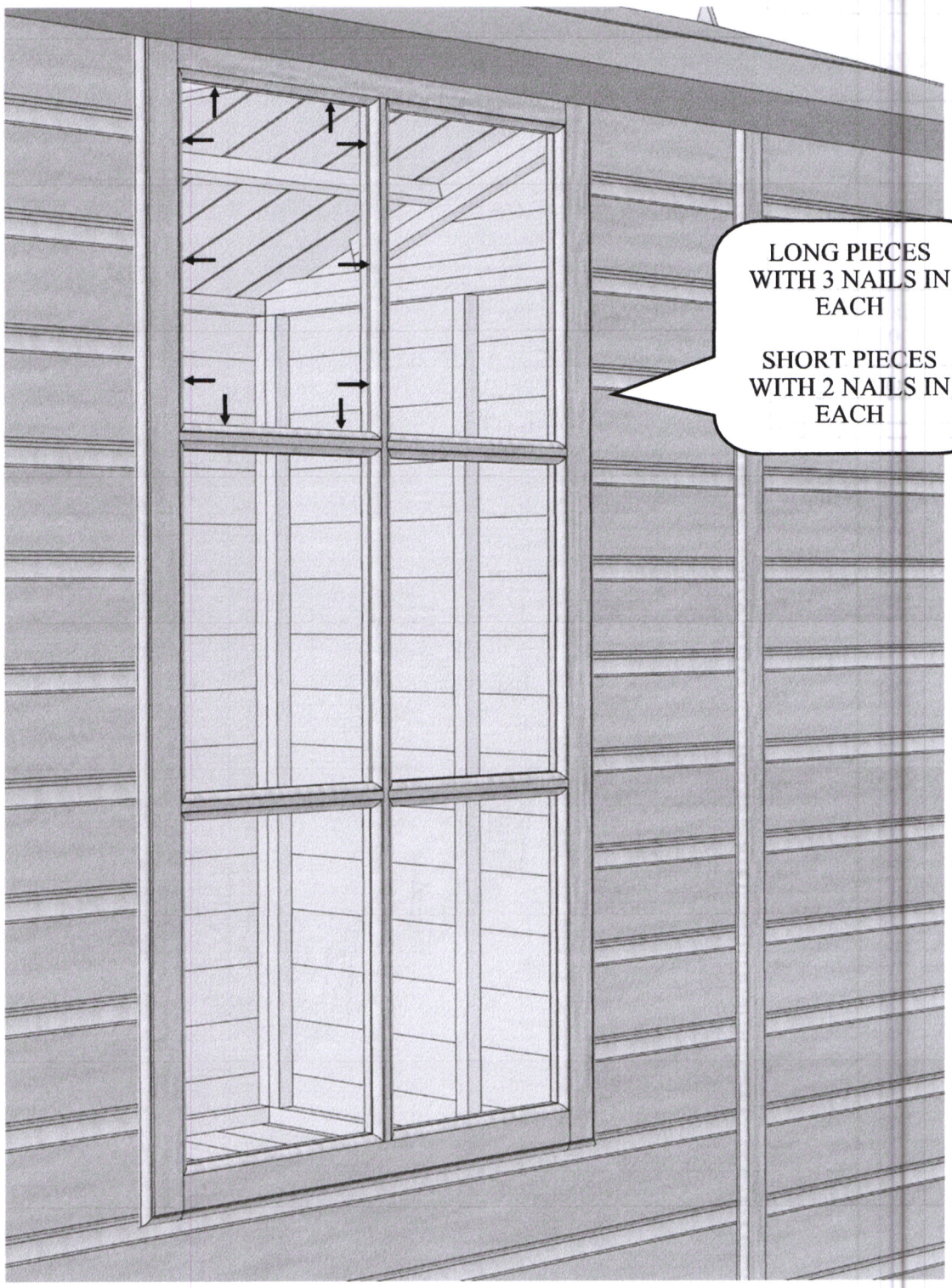

LONG PIECES WITH 3 NAILS IN EACH

SHORT PIECES WITH 2 NAILS IN EACH



WEAR CORRECT SAFETY EQUIPMENT!

