

Section C-C mullion to frame stiles to sashes.

Section B-B Head & Top Rail.
Jamb & Stiles of Sash & Framing

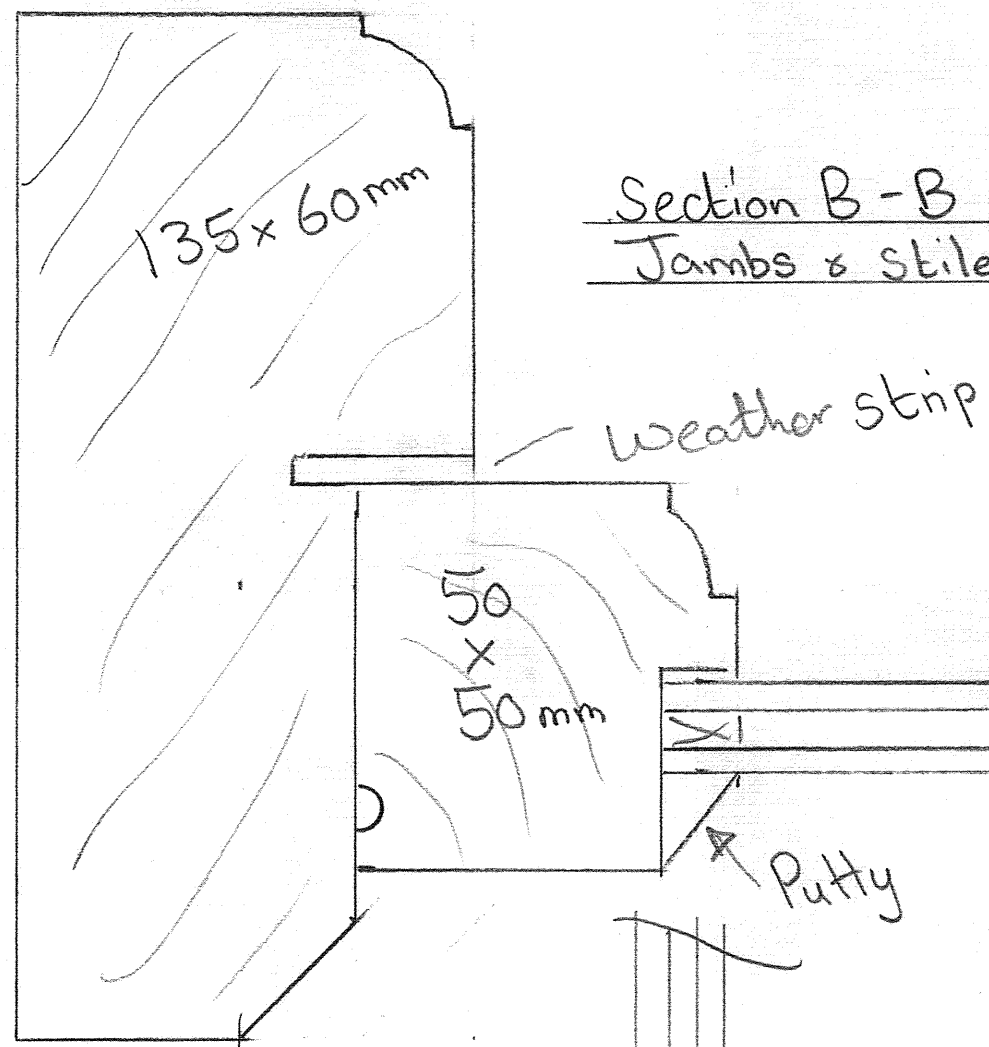

Section D-D. Solid Bar. 26x50mm

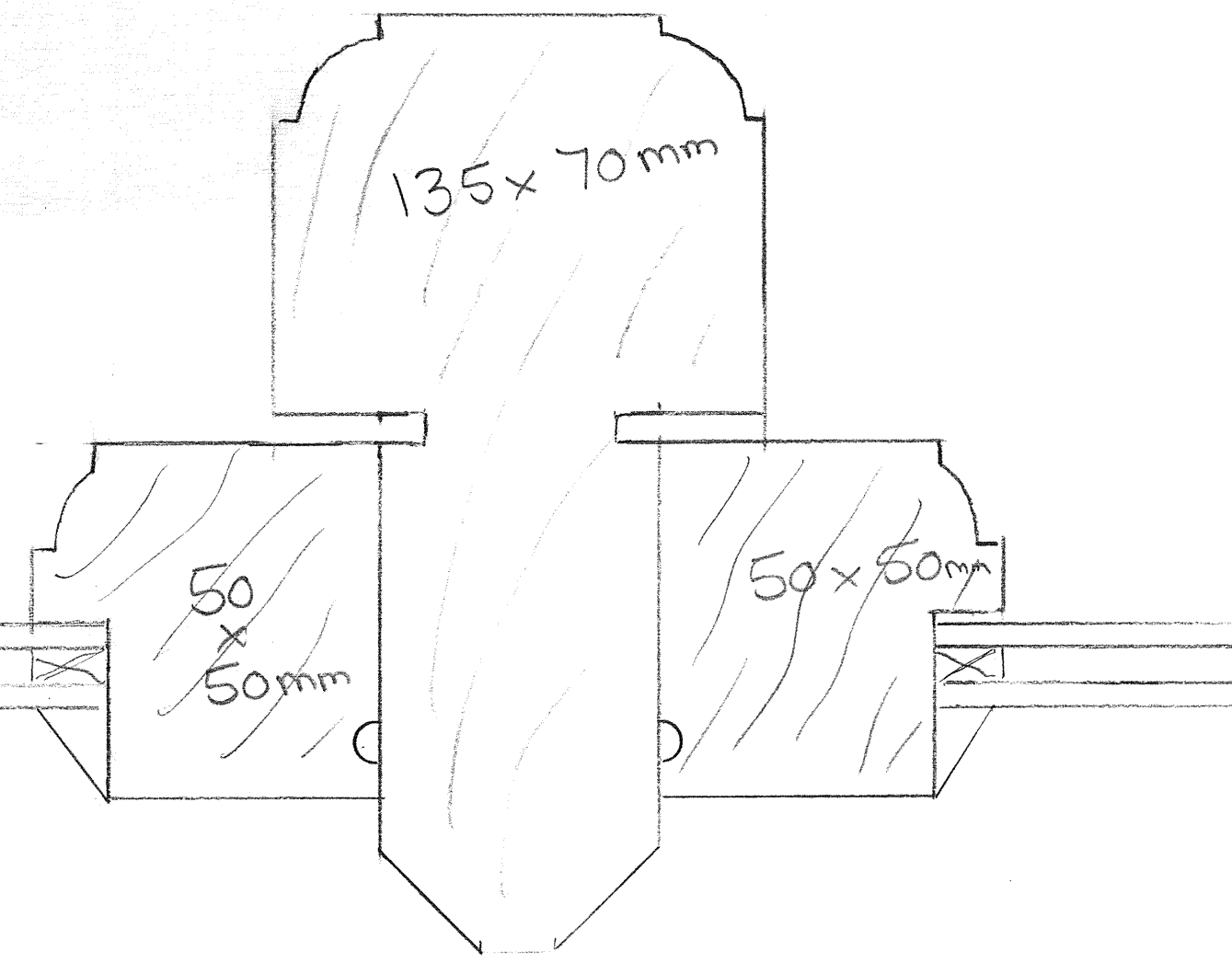
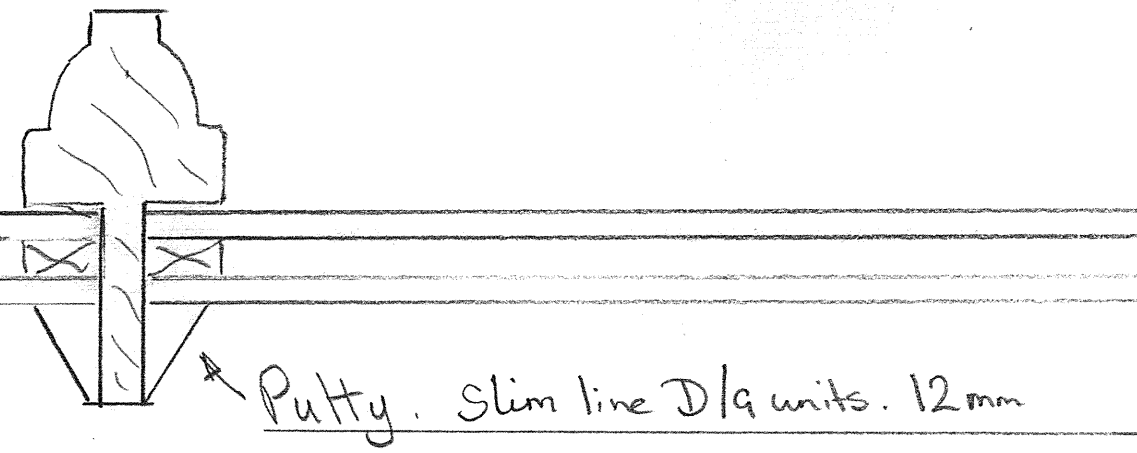

Cill section. A-A
Bottom Rail Section.

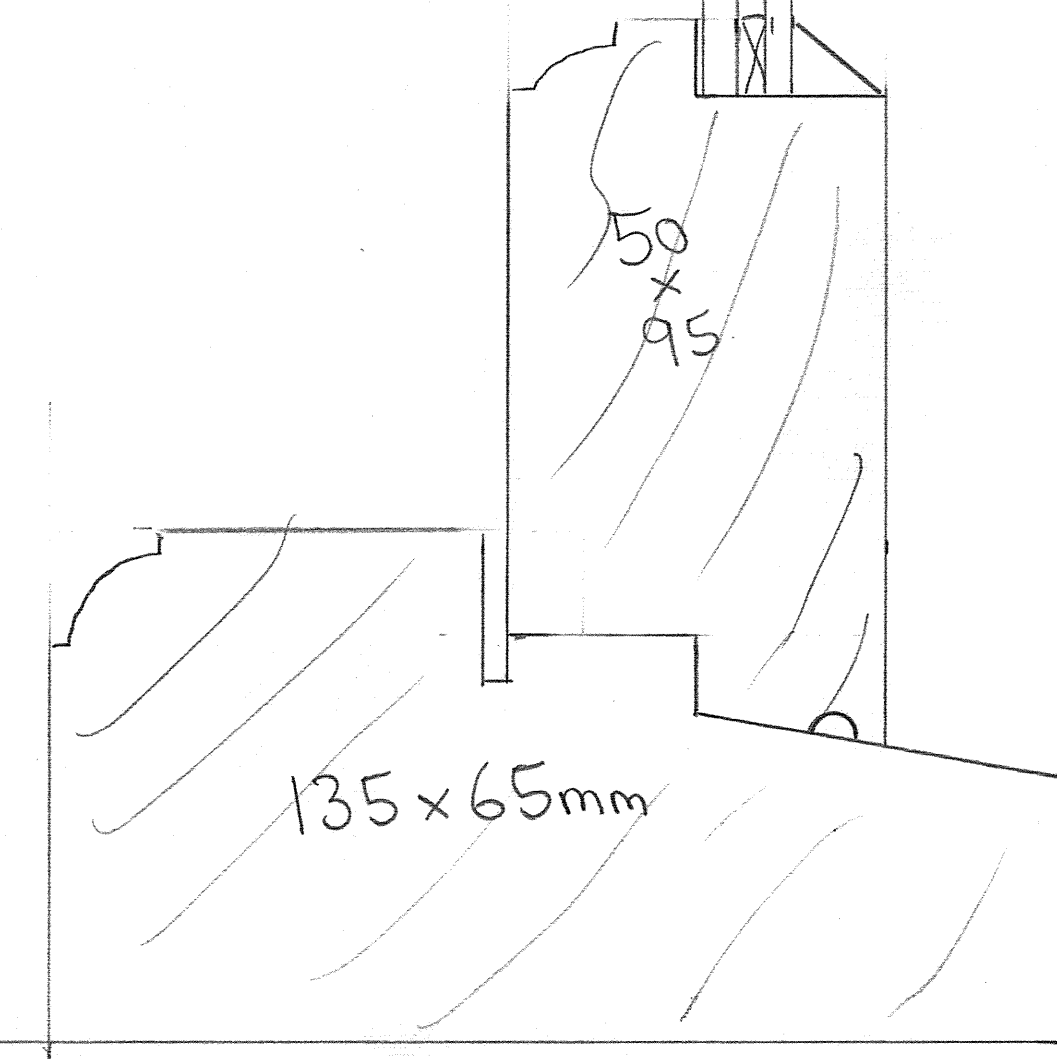

Window 1:10 scale A2

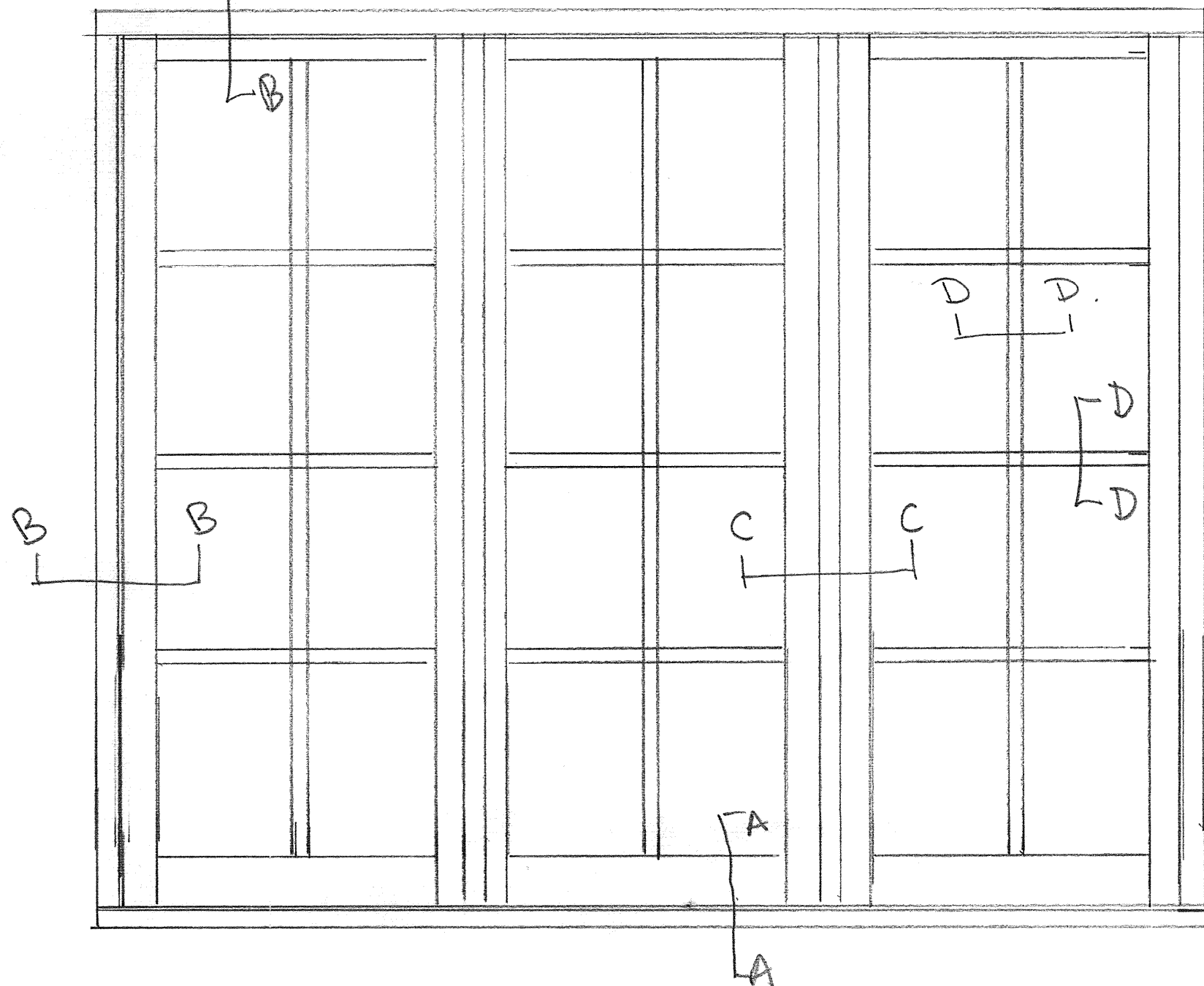

Sawston Joinery
 Full size on A2
 Proposed Casement
 Oval moulded
 Side Hung Slim line units
 DWG of windows
 Slim line D/9 units.

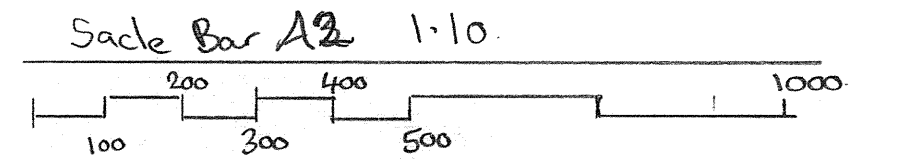
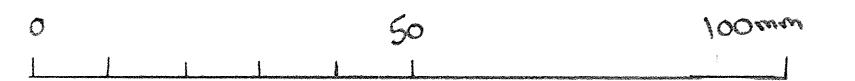

Stone cill.