

TYPICAL GLAZING BAR DETAILS

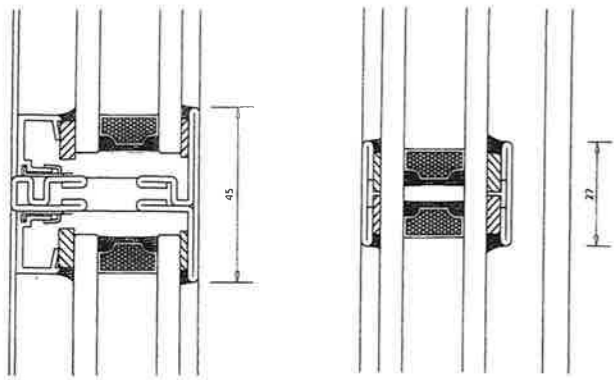

TYPICAL FIXING DETAIL

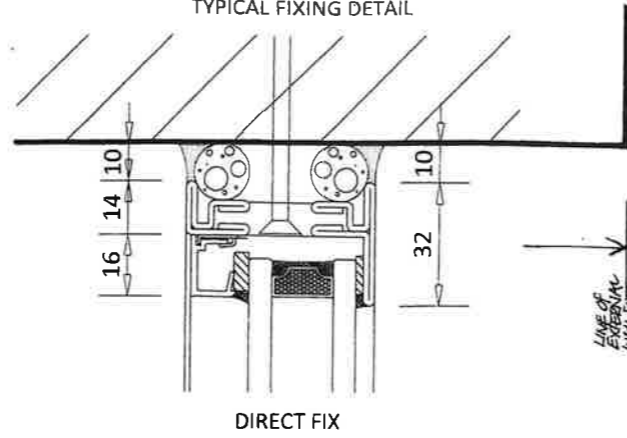

TYPICAL JAMB DETAILS

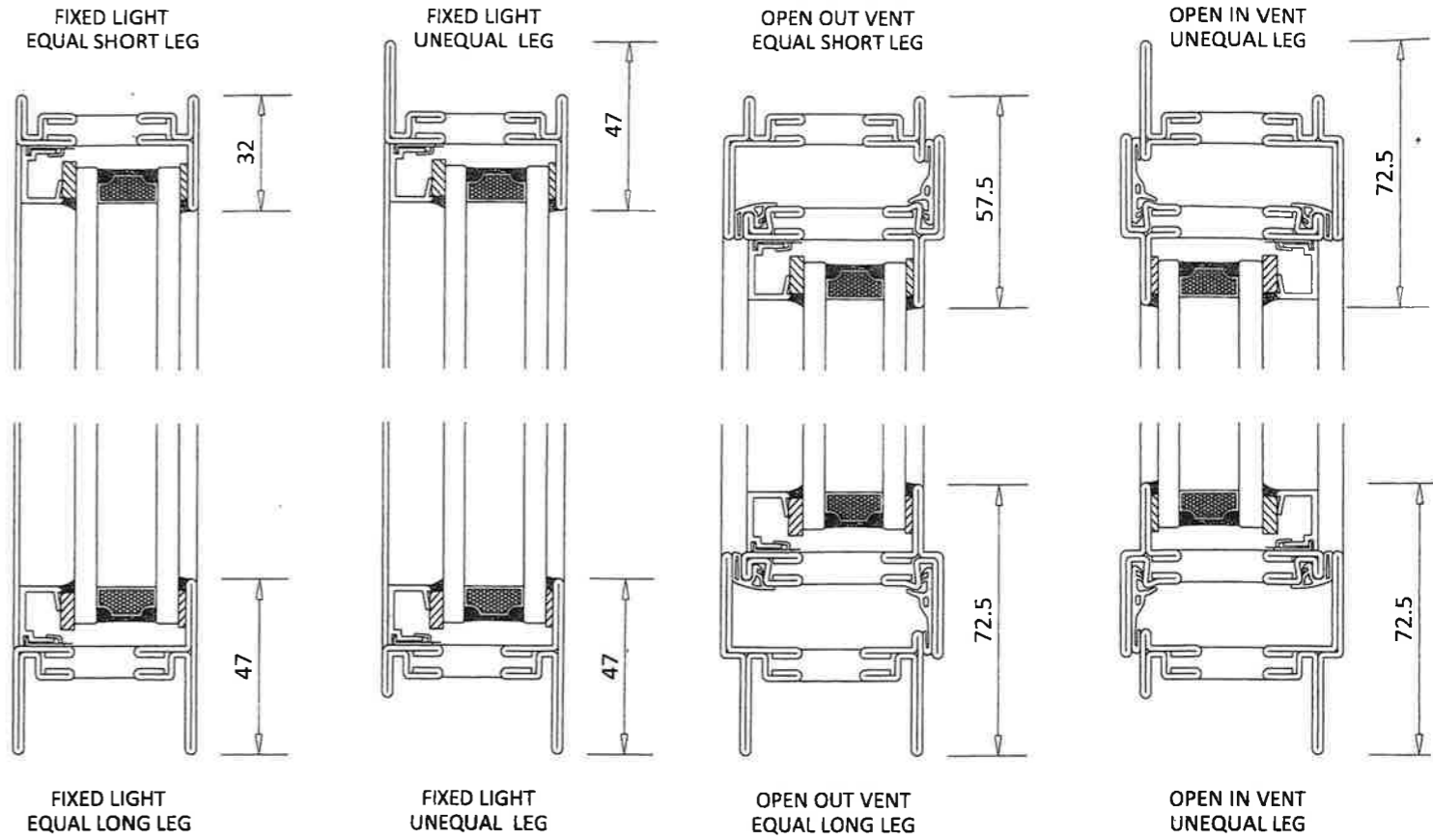

GLAZING DETAILS

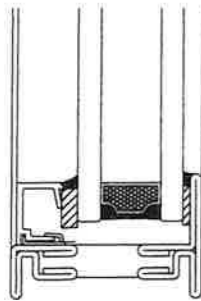

INTERNALLY GLAZED

CRITTALL T60 THERMAL BREAK WINDOW FRAME PROFILES REF. T60 04/19

TYPICAL COUPLING DETAILS

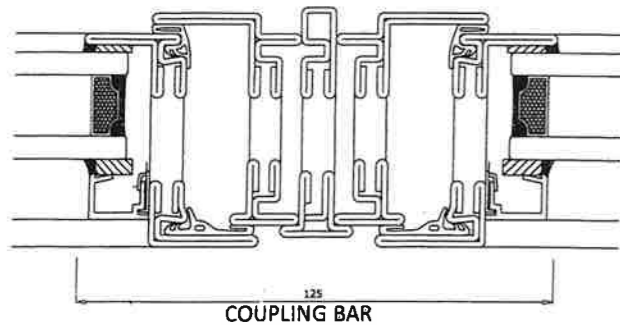

COUPLING BAR

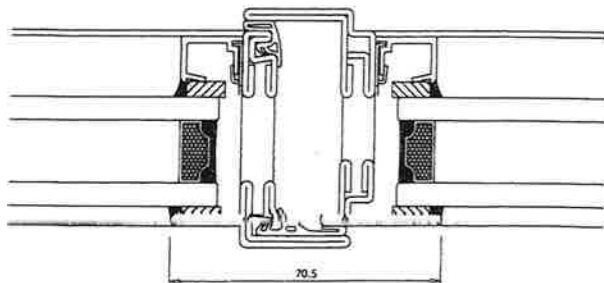

MULTILIGHT

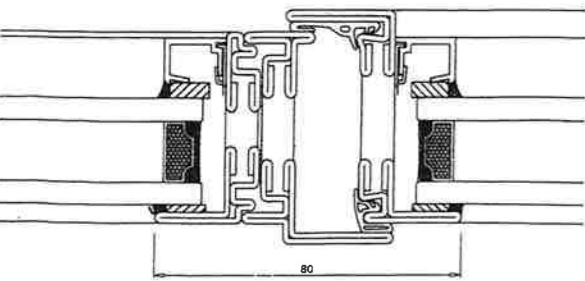

DIRECT COUPLING

TYPICAL MEETING RAIL DETAILS

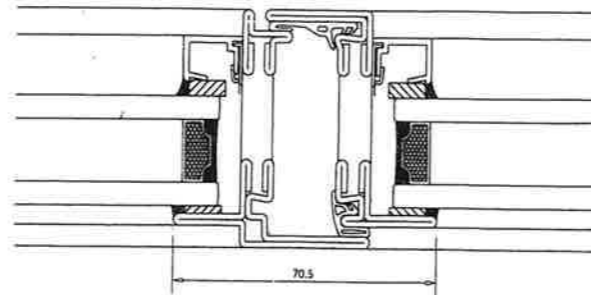

FRENCH CASEMENT

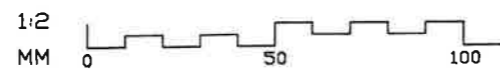

CRITTALL T60 THERMAL BREAK WINDOW FRAME PROFILES

CRITTALL T60 THERMAL BREAK WINDOW FRAME PROFILES REF. T60 04/19

A3 SHEET SIZE

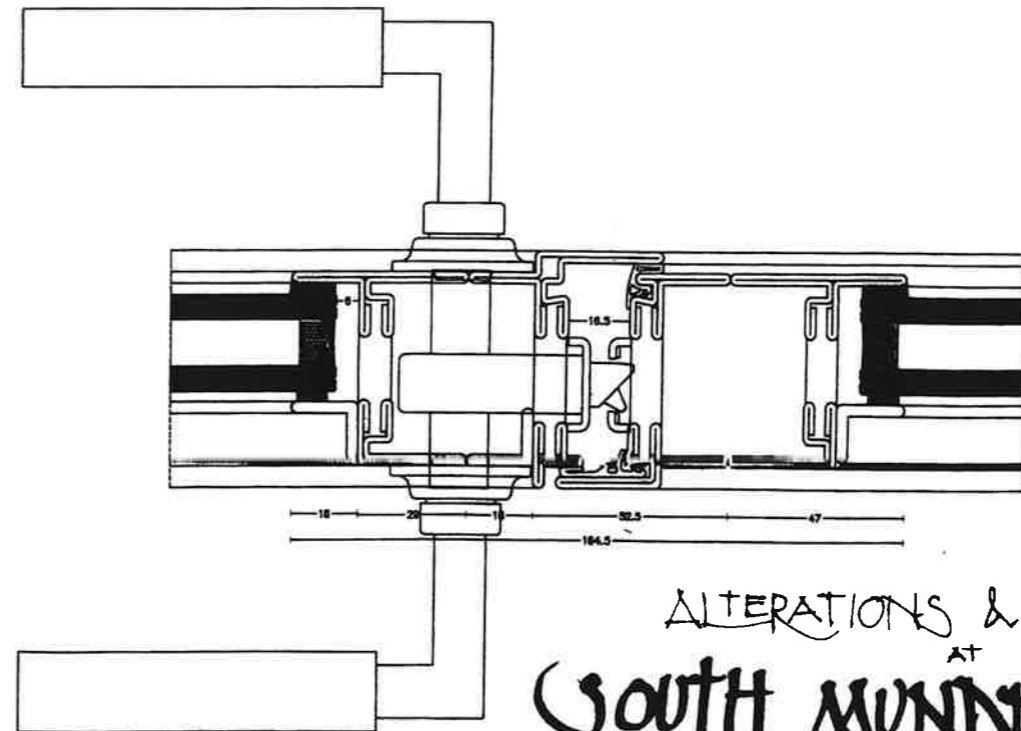

CRITTALL FENDOR
 CRITTALL GROUP COMPANY
 Sales Office, South House, Clarendon Industrial Estate, Halesowen B63 2JH
 TEL: +44 (0)191 417 0170 FAX: +44 (0)191 417 0100
 CRITTALL FENDOR LTD. Registered in England No. 02996
 Registered office: South House, Clarendon Road, Halesowen, West Midlands B63 2JH

CONTRACTOR: CRITTALL FENDOR LTD
 PRODUCT: T60
 TITLE: OPENING HORIZONTAL SECTION DETAILS

ALTERATIONS & EXTENSIONS
 AT
SOUTH MUNDHAM HOUSE
 SOUTH MUNDHAM, WEST SUSSEX
WINDOW AND DOOR DETAILS.
 HALF FULL SIZE (1:2) 0318-32