



TIMBER WINDOWS

ALI TEMENOS





CASEMENT WINDOWS

Smooth to open and beautiful to the touch, the Timber Windows range of Casement Windows provide an appearance that can only be achieved with genuine timber.

With a wide range of designs available, we are confident you will find the perfect Casement Windows for your home - whether you are after a traditional look or something sharper and more contemporary.

Warm, quiet and secure, with timber guaranteed for decades, our casement windows incorporate a host of technical innovations for absolute peace of mind.

The range is presented in a wide variety of colours and stains, including shades complementary to Farrow & Ball or Fired Earth palettes.

Working closely with our customers, we ensure that the designs suit the character, age and construction of their homes; tailoring proportions, sightlines and paint colours to suit.

All of our windows use engineered multi-layered, warp and twist resistant timber throughout their construction.

Beautiful handles and fasteners, in a range of finishes and styles can be selected for the perfect accompaniment to your new Casement Windows.



| | | | | |
|---|--|--|---|---|
| <p>QUOTE PREPARED FOR</p> <p>Ali Temenos Midi Cote Bank Street Bishops Waltham Southampton Hampshire SO32 1AN</p> | <p>SITE ADDRESS</p> <p>(Same as quote address)</p> | <p>PREPARED BY</p> <p>Ian Regan Sales Advisor</p> <p>Showroom: Winchester</p> | <p>LEAD TIME</p> <p>Approximately 18-20 weeks from sign off of final detail.</p> | <p>TERMS</p> <ul style="list-style-type: none"> • Deposit with Order 50%. • Stage payment approximately two weeks prior to installation 40%. • Balance on day of completion 10%. |
|---|--|--|---|---|

SCOPE OF PROJECT

Replacement - Carefully remove existing items, prepare openings and supply and fit replacements. To include all making good of aperture ready for final decoration by others. All installed in full compliance with Building Regulations Document L (2010 Edition) by our trained and experienced installers.

TECHNICAL SPECIFICATION

All products in multi-layer Engineered European Redwood sections for added stability. Factory glazed with krypton gas filled double glazed units featuring soft-coat energy saving glass. Fully factory finished with high performance, micro-porous paint treatments. Flush casement windows with high security multi-point locking systems and locking handles. Conventional Cottage Casement windows with high security multi-point locking systems and locking handles.

PRICE

| | |
|------------------------------|------------|
| Net Price: | £10,709.74 |
| VAT (20%): | £2,141.95 |
| Total Purchase Price: | £12,851.69 |

Your quotation is valid for 30 days from Monday 7th August 2023

Your project is covered by:



Your deposit guarantee and insurance backed warranty policy
 Valid upon registration. Ask for full details.

GUARANTEES



| | | | | | |
|---|---|---|---|---|---|
| Fungal & Insect | Sealed Unit | Hardware | Workmanship | Paint | Stain |
|  |  |  |  |  |  |
| 30 YEARS GUARANTEE | 10 YEARS GUARANTEE | 10 YEARS GUARANTEE | 10 YEARS GUARANTEE | 12 YEARS GUARANTEE | 6 YEARS GUARANTEE |

* 5 years for 14mm double glazed units. * 6 years for Meranti & Redwood. 1 year for Oak. Not applicable to paint finished products.



The mark of responsible forestry

ITEM SUMMARY FOR: Ali Temenos
 QUOTE REF: 4697/1 V1

| ITEM | QTY | ITEM REFERENCE | PRODUCT | REMARKS |
|------|-----|------------------------------|---------------------------------|--|
| 1 | 1 | Bathroom Window | Flush Casement Window | Peardrop - Black handle. Horizontal Astragal Bars. White Finished. |
| 2 | 1 | Bedroom Window | Conventional Cottage Window | Peardrop - Black handle. Horizontal Astragal Bars. White Finished. |
| 3 | 1 | Living Room | Conventional Cottage Window | Peardrop - Black handle. Horizontal Astragal Bars. White Finished. |
| 4 | 1 | Master Bedroom | Flush Casement Window | Peardrop - Black handle. Astragal Squares. White Finished. |
| 5 | 12 | Finishing Trims | Trim: Cover Strip - 8x20 3000mm | White Finished. European Redwood FSC. Profile:  |
| 6 | 4 | External Cheeks (Master Bed) | Trim: Flat - 20x150 2350mm | White Finished. European Redwood FSC. Profile:  |

1. Flush Casement Window (Bathroom Window)

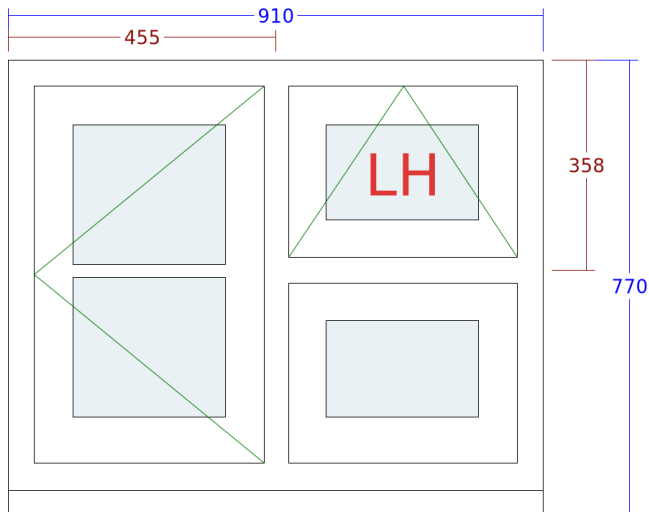

2. Conventional Cottage Window (Bedroom Window)

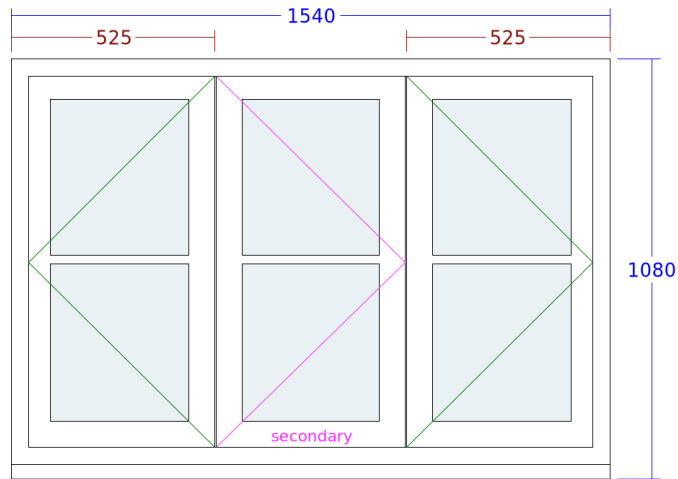

3. Conventional Cottage Window (Living Room)

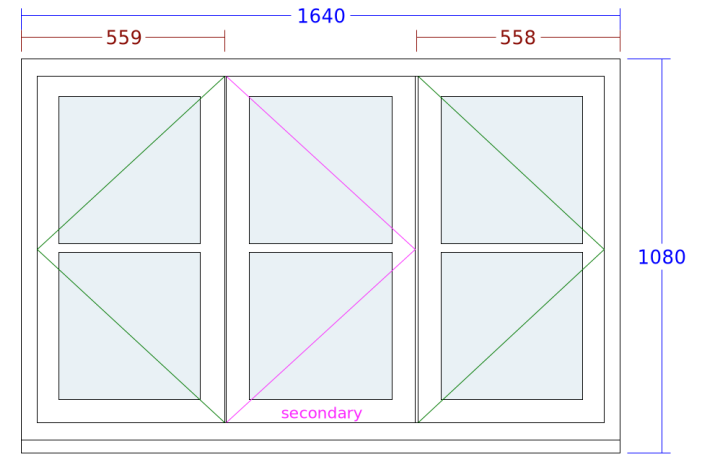

4. Flush Casement Window (Master Bedroom)

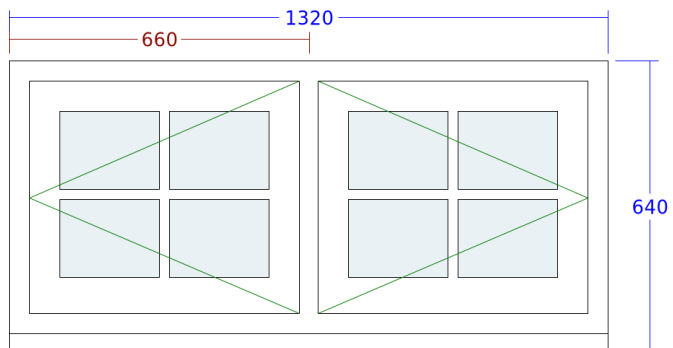

FLUSH CASEMENT WINDOW
ENGINEERED EUROPEAN REDWOOD



QUOTE REF: 4697/1 V1
ITEM REFERENCE: Bathroom Window

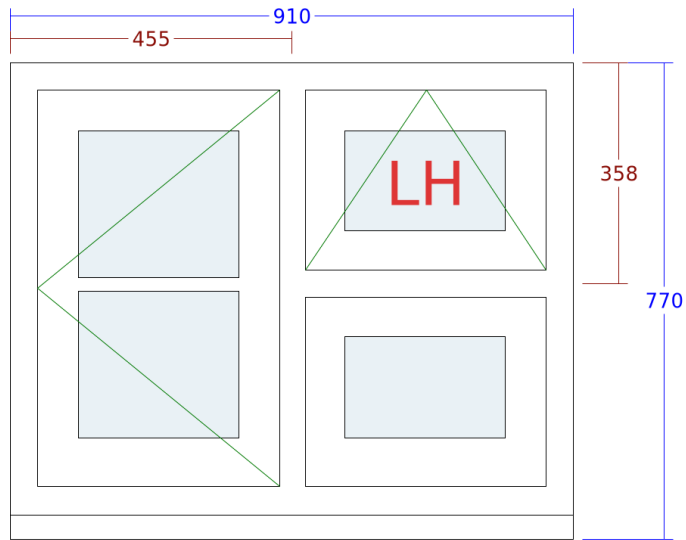

Drawing Notes: Viewed from outside. Point of arrow denotes hinge position.

SIZE SPECIFICATIONS

| | |
|-----------------|-----------------------------------|
| Cill | 145mm x 38mm (inc. in overall ht) |
| Frame Head Size | 60mm |
| Height | 770mm |
| Size Of Bar | 22mm (True Bar) |
| Width | 910mm |

TECHNICAL SPECIFICATIONS

| | |
|------------------------|--|
| Add Ons Required | No |
| Cill Horns | No |
| Cill Species | Engineered European Redwood |
| Dummy Hinges | None |
| Equal Height Squares | Below Transom |
| Equalise Glass Widths | Yes |
| Feature Mould | Ovolo |
| Glass Type | 4mm Tgh/6mm Krypton/4mm Tgh LowE (Putty Glazed) |
| Glazing Features | Horizontal Astragal Bars |
| Head Drip | None |
| Hinge System | Pivot with Seigenia locks |
| Peg Stay Alignment | Opening end pointing to handle |
| Style Option | Dummy Sash |
| Trickle Vents Required | No |
| Window Board Required | No |

IRONMONGERY OPTIONS

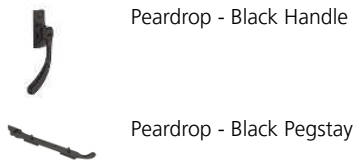

COLOUR CHOICES



GLASS & FRAME CHOICES

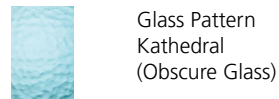

CONVENTIONAL COTTAGE WINDOW
ENGINEERED EUROPEAN REDWOOD



QUOTE REF: 4697/1 V1
ITEM REFERENCE: Bedroom Window

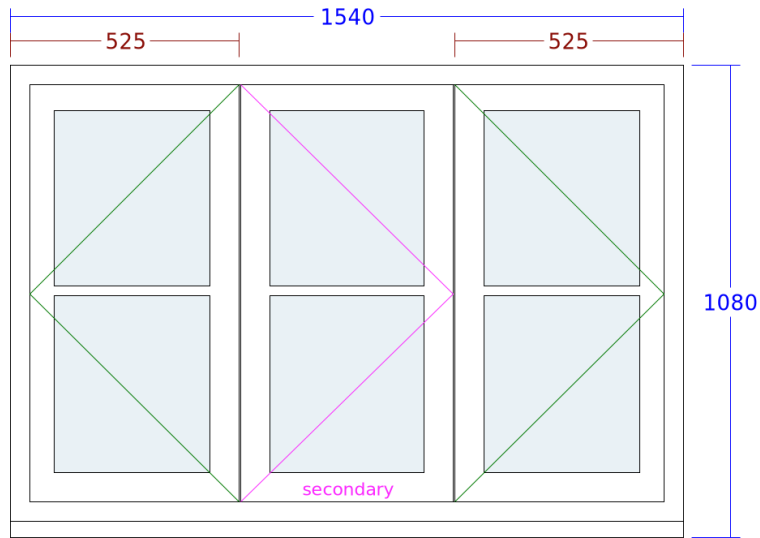

Drawing Notes: Viewed from outside. Point of arrow denotes hinge position.

SIZE SPECIFICATIONS

| | |
|-----------------|-----------------------------------|
| Cill | 145mm x 38mm (inc. in overall ht) |
| Frame Head Size | 60mm |
| Height | 1080mm |
| Size Of Bar | 22mm (True Bar) |
| Width | 1540mm |

TECHNICAL SPECIFICATIONS

| | |
|------------------------|--|
| Add Ons Required | No |
| Cill Horns | No |
| Cill Species | Engineered European Redwood |
| Dummy Hinges | None |
| Feature Mould | Ovolo |
| Glass Pattern | Clear |
| Glass Type | 4mm Anl/6mm Krypton/4mm Anl LowE (Putty Glazed) |
| Glazing Features | Horizontal Astragal Bars |
| Head Drip | None |
| Hinge System | Pivot with Kenrick locks |
| Peg Stay Alignment | Opening end pointing to handle |
| Swept Heads | No |
| Trickle Vents Required | No |
| Window Board Required | No |

IRONMONGERY OPTIONS

-  Peardrop - Black Handle
-  Peardrop - Black Pegstay

COLOUR CHOICES

-  Colour White (RAL 9003)

CONVENTIONAL COTTAGE WINDOW
ENGINEERED EUROPEAN REDWOOD



QUOTE REF: 4697/1 V1
ITEM REFERENCE: Living Room

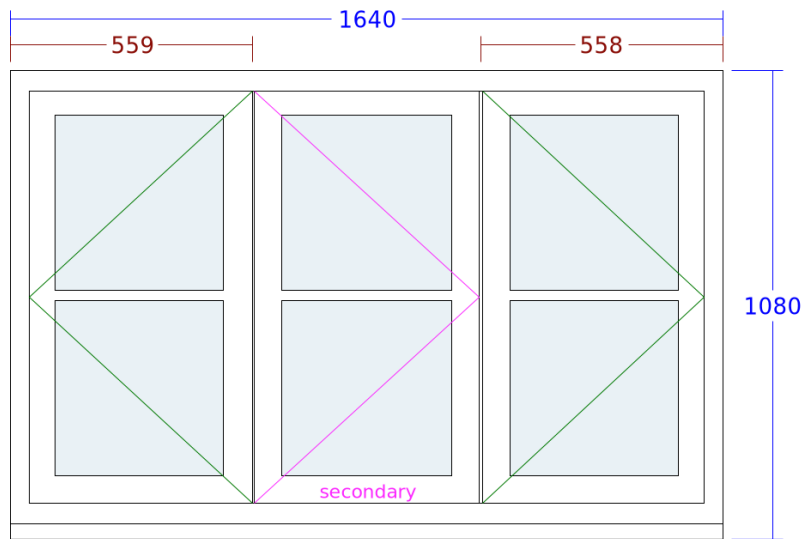

Drawing Notes: Viewed from outside. Point of arrow denotes hinge position.

SIZE SPECIFICATIONS

| | |
|-----------------|-----------------------------------|
| Cill | 145mm x 38mm (inc. in overall ht) |
| Frame Head Size | 60mm |
| Height | 1080mm |
| Size Of Bar | 22mm (True Bar) |
| Width | 1640mm |

TECHNICAL SPECIFICATIONS

| | |
|------------------------|--|
| Add Ons Required | No |
| Cill Horns | No |
| Cill Species | Engineered European Redwood |
| Dummy Hinges | None |
| Feature Mould | Ovolo |
| Glass Pattern | Clear |
| Glass Type | 4mm Anl/6mm Krypton/4mm Anl LowE (Putty Glazed) |
| Glazing Features | Horizontal Astragal Bars |
| Head Drip | None |
| Hinge System | Pivot with Kenrick locks |
| Peg Stay Alignment | Opening end pointing to handle |
| Swept Heads | No |
| Trickle Vents Required | No |
| Window Board Required | No |

IRONMONGERY OPTIONS

-  Peardrop - Black Handle
-  Peardrop - Black Pegstay

COLOUR CHOICES

-  Colour White (RAL 9003)

FLUSH CASEMENT WINDOW
ENGINEERED EUROPEAN REDWOOD



QUOTE REF: 4697/1 V1
ITEM REFERENCE: Master Bedroom

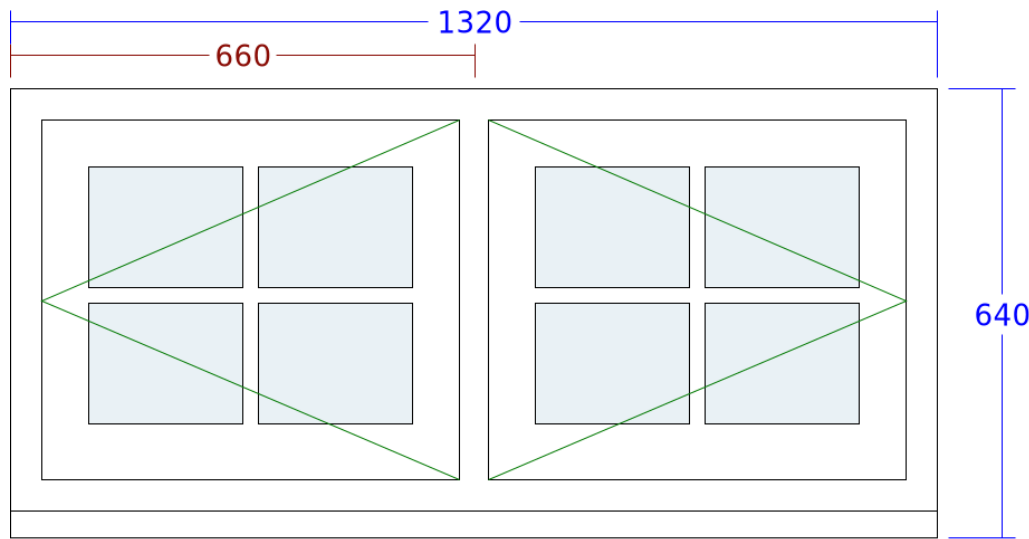

Drawing Notes: Viewed from outside. Point of arrow denotes hinge position.

| SIZE SPECIFICATIONS | |
|---------------------|-----------------------------------|
| Cill | 145mm x 38mm (inc. in overall ht) |
| Frame Head Size | 60mm |
| Height | 640mm |
| Size Of Bar | 22mm (True Bar) |
| Width | 1320mm |

| TECHNICAL SPECIFICATIONS | |
|--------------------------|--|
| Add Ons Required | No |
| Cill Horns | No |
| Cill Species | Engineered European Redwood |
| Dummy Hinges | None |
| Equalise Glass Widths | Yes |
| Feature Mould | Ovolo |
| Floating Mullion | No |
| Glass Pattern | Clear |
| Glass Type | 4mm Anl/6mm Krypton/4mm Anl LowE (Putty Glazed) |
| Glazing Features | Astragal Squares |
| Head Drip | None |
| Hinge System | Pivot with Seigenia locks |
| Peg Stay Alignment | Opening end pointing to handle |
| Trickle Vents Required | No |
| Window Board Required | No |

IRONMONGERY OPTIONS



Peardrop - Black Handle

Peardrop - Black
Pegstay

COLOUR CHOICES





Colour
White
(RAL 9003)





WHAT MAKES OUR PRODUCTS SPECIAL?

All of our windows and doors are bespoke; this means they are made to the exact requirements of you the customer and of your home. They combine traditional or contemporary appearance with 21st century advances in security and insulation.

 **Frames are manufactured using quality, seasoned engineered timber** – which provides resistance against twisting and jamming as the opposing grains even out natural moisture movement.

 **Comprehensive insurance backed guarantees of up to 30 years** – covering your deposits and your installation for added piece of mind.

 **Four stage factory sprayed micro-porous coatings** – ensure a pristine, low maintenance finish with a guarantee to the term of 12 years on paint finishes and up to 6 years on stained without the need for redecoration.

 **Factory fitted energy saving double glazed units** – which are almost twice as effective at retaining heat as regular double glazing. Heat reflective coatings and argon filled units provide a class leading U-value of 1.1 W/m²K.

 **Internally beaded glass** – means more secure windows and doors as the glazing cannot be removed from the outside. The bead of externally glazed products is always a point for water ingress, rot and can lead to premature unit failure.

 **Windows are fitted with perimeter locking systems** – which pull the opening window tight against the seals for security, heat insulation and noise insulation. All window handles are key locking to meet current insurance requirements.

 **Doors are fitted with full height locking systems** – and solid brass or stainless steel hinges for security and weather tightness. Cylinders are snap-safe, anti-bump, anti-pick and anti-drill to combat modern methods of burglary.

 **Vented and drained double glazed units** – allow moisture to escape and air to flow around the seals to prevent premature misting and failure of the glass. Units carry a 10 year guarantee.

 **Dual colour and colour matching available** – we are able to offer a range of colours that complement those from well-known paint brands such as Farrow & Ball, Fired Earth and RAL colours.

 **A huge choice of traditional and contemporary hardware** – to suit all types of property. Choose from a purpose designed suite from Samuel Heath and a range of traditional ironmongery designed by 'Timber Windows'.

 **Selection of astragal glazing bar sizes** – to choose from. Bars are manufactured as a separate cassette which is preassembled and jointed with screws and staples. It is then bonded to the glass, pinned into the frame and sealed with a 'flexi-seal'. This avoids the problems associated with joinery products when bars are mitred and individually double-sided taped to the glass with no additional protection.

HIGH PERFORMANCE ENGINEERED TIMBER PRODUCTS