



Alitherm Heritage

The smart solution for heritage applications



◆ **In the last 35 years, Smart Architectural Aluminium has grown to become the UK's leading manufacturer and supplier of aluminium systems**

During that time, we have built an enviable reputation not only for the quality, breadth and depth of our product ranges, but also for our innovative and flexible approach to product innovation and the quality of our design expertise and technical support services.

In the UK, we operate from a purpose-built 45,000m² plant which houses offices, three



state-of-the-art extrusion presses, three 100% chromate-free polyester powder coating paint lines and our logistics and distribution hub – all of which are dedicated to meeting our customers' specific needs. We have also installed a dedicated paint line for hardware and accessories, ensuring we deliver consistent and precise colour matches for every project.

As a business, we are fully committed to delivering sustainable processes and materials – a manifestation of which is our objective of becoming both carbon-neutral and energy self-sufficient.

Our continued investment in and focus on sustainable solutions, builds on the success of a number of recent initiatives, including

the implementation of a range of environmental policies and procedures; an ISO14001 Environmental Management System and the introduction of strict recycling protocols.



BES 668681



FM21582



EMS554307



OHS571955



ENMS634370



Alitherm Heritage

The perfect solution for sensitive refurbishment and renovation projects.

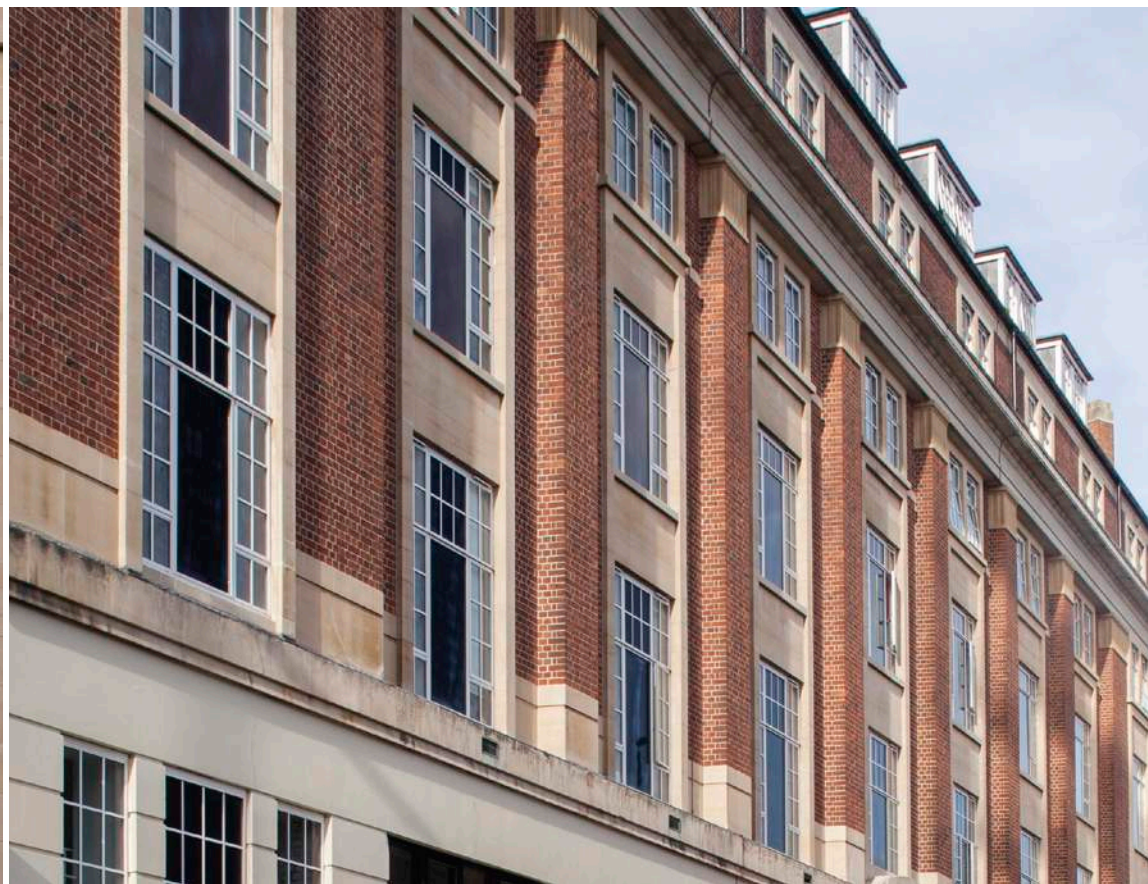

We designed and developed the Alitherm Heritage ranges specifically to meet the requirements of refurbishment and renewal projects, particularly in sensitive planning areas. Ideal for Victorian and Art Deco projects, the range of commercial and residential windows and balcony doors are already proven in a wide range of renovation, refurbishment and heritage projects across the UK.

◆ Alitherm Heritage's signature slim profiles and slightlines are the ideal solution for listed building renovations

Providing a modern, like-for-like replacement for traditional materials, Alitherm Heritage is the ideal solution for projects where planning or design demands dictate the installation of sympathetic materials – even for listed buildings. The system has already been approved for projects in a number of Local Authorities (including the London Boroughs of Islington, Camden and Tower Hamlets, Watford Borough Council and Essex County Council) as well as Cadw, the Welsh Government's historic environment service.

The Alitherm Heritage door and window ranges both feature the slim profiles and sight lines that are associated with traditional steel doors and windows.

However, the system's timeless elegance is also accompanied by the outstanding thermal performance of a modern aluminium system – each delivering a 'B' Energy Rating. Featuring slim, thermally-broken profiles, Alitherm Heritage windows are available in a number of formats, including fixed-pane, sash, top-hung and side-hung casement, pivot and tilt and turn. These different options may be installed in a combination of horizontal modules, which are stacked using our coupling options to form a multi-part window.

Suitable for both single and double door application, Alitherm Heritage balcony doors are available in a wide range of

sizes and are supplied with a multi-point lock mechanism as well as face-mounted finger thrown locking bolts. Both the window and door systems deliver a U-Value of 1.5 W/m²K, when installed with a suitable sealed unit, and are available in either single or dual polyester powder coated finishes.

Aluminium versus Steel

Delivering improved thermal efficiency and long-life performance.

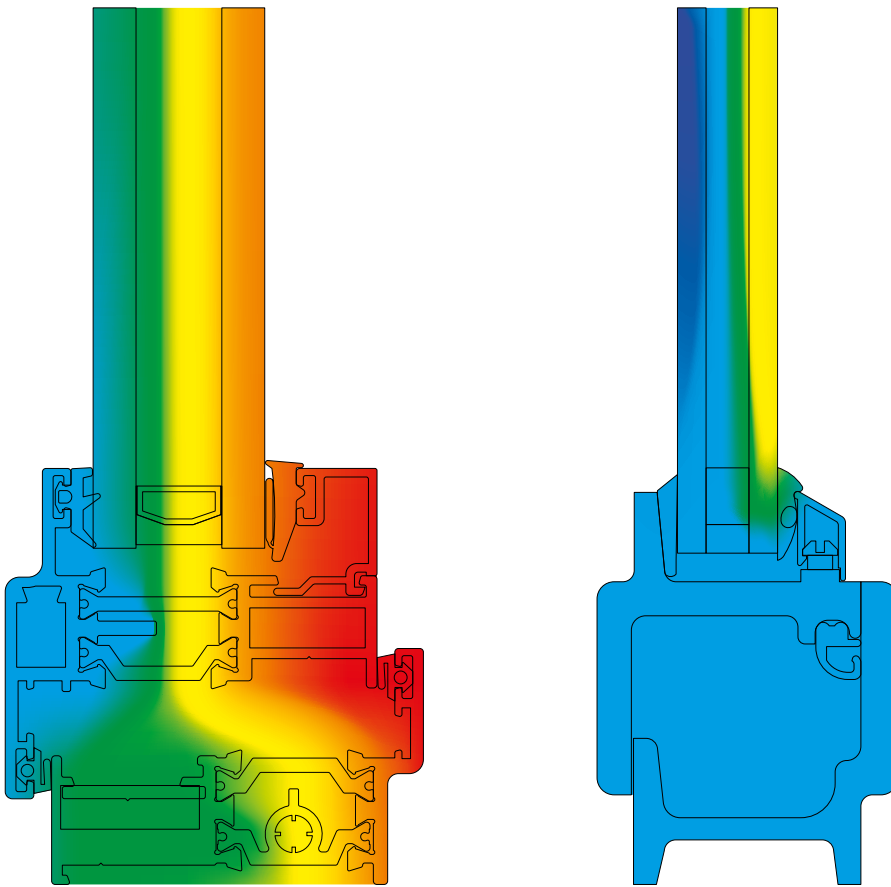

Building on over 35 years' design and development experience, our R&D engineers have produced a complete range of integrated door and window systems that deliver not only the aesthetics required for sensitive Victorian and Art deco refurbishment projects, but also the thermal efficiency that is demanded by developers, architects, planners and building occupiers.

Alitherm Heritage provides a modern light-weight, high-strength and cost-effective alternative to traditional steel window and door systems, offering a wide range of benefits:

Increased Lifespan

Because aluminium does not rust or rot, window frames provide great longevity and can last indefinitely. This also means that the aluminium windows have the longest lifespan of any window framing material, with typical replacement periods of 40 years – compared to a typical 35 year replacement period for steel, PVC and timber.

(Source: BRE British Research Establishment)

Improved Thermal Efficiency

Modern aluminium windows are thermally-broken using polyamide, an excellent insulator which helps to insulate windows against heat loss.

The thermal conductivity of polyamide is 160 times better than steel, which for a typical terraced house would provide a saving of around £95 each year in fuel costs. In addition to these energy savings, the polyamide also raises the internal temperature of a house, helping to reduce the risk of condensation.

(Source: GGF Energy Saving Calculator)

Reduced Maintenance

Maintenance for aluminium systems is simple and straightforward, with a routine 'wipe-clean' all that is required to

keep the products looking their best. With no requirement for re-painting or re-varnishing, aluminium windows and doors will never fade, deteriorate or rust, even in harsh environments, such as coastal locations, where steel windows can be particularly prone to rust, requiring regular maintenance and eventually, replacement. For example, the Sully Hospital overlooking the Bristol channel, the building's original steel window frames became heavily corroded and covered in rust. These were then replaced with aluminium window frames with a marine grade polyester powder coating to provide long-life performance with minimal maintenance.

Above Left – Polyamide thermal break technology and modern profile design enhances the thermal performance of Alitherm Heritage compared to steel windows.

Above – Alitherm Heritage closely replicates the aesthetics of steel windows. The window shown above is steel; the window below is Alitherm Heritage.

Hardware

Full range of hardware and colour options.



Lever/Lever Art-Deco Door Handle



Bulb-End Window Handle



Art-Deco Window Handle



Monkey-Tail Window Handle



Bulb-End Peg Stay



Our Alitherm Heritage ranges are all available with a full suite of hardware options, with products specifically designed to match the door and window furniture that is synonymous with Victorian and Art Deco styles – including 'Monkey Tail' and 'Bulb' options.

Both the window and door systems, and accompanying hardware and accessories may be supplied in any colour from our extensive Naturals and RAL ranges, as well as our

bespoke Sensations colours and our recently launched Alchemy range. Alchemy offers eight anodised colour matches, including shades of gold, bronze, silver, grey

and black, and combines the unique style and aesthetics of traditional anodising, with the advantages of a high quality powder coating process.

Case Study: Purifier House

Location
Purifier House
Lime Kiln Road, Bristol BS1 5AD

Architect
AWW
70 Redcliff St, Bristol BS1 6LS

Developer
Linden Homes
Cowley Business Park, Uxbridge



Summary

Alitherm Heritage windows, together with Smart commercial doors and ground floor framing, were installed as part of Linden Homes' development of the Grade II listed Purifier House, situated in the heart of Bristol's Harbourside area.

Once a gas purifying station, Purifier House dates back to the 1820s and was in regular use up to the 1960s. The building then fell into a state of disrepair and became derelict in the 1970s. However, being situated in the City Docks Conservation Area, Purifier House was listed to Grade II status in 1985 – although all that remained of it was its existing walls, which were

strapped and braced to avoid further deterioration.

Linden Homes' redevelopment transformed Purifier House into elegant waterfront homes in one of Bristol's most vibrant locations. 28 apartments have been created above ground floor retail and café space which overlooks the Harbourside and

provides a valuable addition to the area. The selection of Alitherm Heritage for the scheme allowed the buildings iconic arch-headed and bullseye windows to be re-created in modern materials, maintaining its distinctive appearance while delivering the thermal and performance benefits of a modern aluminium window system.

Case Study: Electricity House

Project
Electricity House
Colston Avenue, Bristol, BS1 4TB

Architect
Stride Treglown
Bristol, BS8 3NE

Developer
Crest Nicholson
Chertsey, KT16 9GN



Summary

Situated within a conservation area, the imposing, Grade II-listed Electricity House has been restored to its former glory and has been transformed into a mixed-use development of 85 high-specification luxury apartments and commercial space.

Many of the original Art Deco features have been recreated, including the style of the window and door systems from Smart, specified both for their authentic appearance and outstanding performance.

Smart's Alitherm Heritage system provided the perfect solution for windows from the first to the fifth floor of the building, with Smart EcoFutural system providing an

equally elegant and thermally-efficient solution for the fifth-floor balcony doors. 10 Sets of double doors were also specified, together with seven sets of Smart Wall commercial doors for the ground floor retail areas – including one automatic door for the disabled access entrance.

In excess of 300 windows were supplied and installed, and despite the exceptionally slim lines of the

Alitherm Heritage system, the units accommodated 36mm double glazed units to cater for the different acoustic requirements of the project.



ELECTRICITY HOUSE

EH

SEE US AT THE OPENING OF THE NEW ELECTRICITY HOUSE ON 15th FEBRUARY 2017

MARKETING SOLUTIONS SALES 0-9
0117 2444 047

Case Study: Lanchester Free School

Project
Lanchester Free School
Hertfordshire, WD17 3HD

Architect
Martindales Architects
Oakington Business Park, CB24 3DQ

Main Contractor
Borras Construction
Salar House, St Albans AL1 5HT



Summary

Windows and doors from our Alitherm Heritage range featured in the refurbishment of the Art Deco-style Lanchester Building in Watford, the building being locally listed due both to its historical and its architectural significance.

Originally built in 1938, the Lanchester Building has been completely transformed by Martindales Architects into a two-form entry primary school and nursery for West Herts Community Free School Trust, and is now home to the Lanchester Community Free School.

With a design requirement to retain the slim lines of the building's original steel windows, so closely associated with Art Deco buildings,

over 70 window assemblies (covering approximately 650m² in total) and 15 door entrance assemblies were installed from our Alitherm Heritage range, the doors being set in the Smart Wall framing system. The window and door profiles were all finished in white polyester powder coating at our state-of-the-art paint facility, matching the materials being replaced and providing a robust, durable and low-maintenance finish.

Despite a particularly tight build programme to meet the school's opening date, the windows and doors were all installed on-time by Dotcom Glazing who worked closely throughout the project with Smart.



Case Study: Mount Pleasant

Location
Mount Pleasant
Clerkenwell, London EC1A 1BB

Architect
Boyes Rees
Greyfriars Rd, Cardiff CF10 3AL

Main Contractor
Mace
155 Moorgate, London, EC2M 6XB



Summary

Originally built in the 1880s, Royal Mail's Mount Pleasant sorting office has now been modernised, with a major feature of the refurbishment programme being the replacement of the existing uPVC windows in the main administration building with the Smart Alitherm Heritage window system.

The new windows replicate the aesthetics of the building's original bronze fenestration, echoing its slim sight lines and finish (the building originally featured large bronze windows, but in a 1980s refurbishment, these were replaced with white uPVC units).

Each of the Smart window units is an impressive eight metres wide by four and a half metres high and was manufactured in a dual colour format, with the external profile

featuring a bronze polyester paint finish and the internal profile standard white.

Given the exceptional scale of each window unit, and their corresponding performance requirement, Smart's technical services team designed and developed a bespoke, 85mm coupling mullion to reinforce and strengthen the system, while retaining its characteristic slim profile. As part of the

redevelopment, new Alitherm Heritage windows were also installed around the building's stairwell – these were externally-beaded to allow maintenance to take place without having to access the lift shaft.



Product Specification

Wide range of high quality, thermally-broken window options.



Alitherm Heritage Window

Alitherm Heritage provides the ideal solution for heritage applications such as listed building renovations and large scale replica-refurbishment projects where planning constraints are to be considered.

The Alitherm Heritage window is designed to be built as a series of horizontal modules which can be stacked using horizontal couplers to form a multi-part window featuring a specially design drip bar between modules.

Application

- ◆ Fixed windows
- ◆ Single or double sash, side hung open out casements
- ◆ Top hung open out casements
- ◆ Tilt & turn windows
- ◆ Pivot windows

Features

- ◆ Polyamide thermal break provides enhanced thermal performance
- ◆ Designed as a direct replacement for steel windows

Finish

Single or dual colour, marine quality polyester powder coat as standard

Technical Performance

WER Rating	B
U Value	1.5 W/m ² K (using sealed unit 1.0 W/m ² K)
Air	Class 4, 600Pa
Water	Class 9A, 600Pa
Wind	Class AE, 2400Pa

Document L Compliant

Dimensions

Frame Depth	47mm
Glass	24mm, 28mm, 32mm & 36mm

Test Certification

BS 6375 Part 1	2009 Resistance to Weather
PAS 24:2016	Enhanced Security Performance

Recommended Design Limits

Side Hung Vent Max o/a Width	700mm
Side Hung Vent Min o/a Width	300mm
Side Hung Vent Max o/a Height	1400mm
Maximum Vent Weight	40kg
Top Hung Vent Max o/a Width	1400mm
Top Hung Vent Max o/a Height	1300mm
Top Hung Vent Min o/a Height	275mm
Maximum Vent Weight	40kg



Product Specification

Choice of single and double doors specifically for heritage projects.

Alitherm Heritage Door

The Smart Alitherm Heritage door is the ideal replacement for steel balcony doors on heritage applications such as building renovations or apartment conversions. The Alitherm Heritage door provides the solution for conservation areas where planning regulations require a like-for-like product replacement.

Alitherm Heritage door profiles feature the system's signature slim sightlines and elegant lines that complement Smart's existing Alitherm Heritage window and mimic those of steel doors. The system has all the advantages of modern aluminium profiles that feature polyamide thermal breaks, allowing the system to achieve a U Value of 1.5 W/m²k when installed with a suitable sealed unit.

Application

- ◆ Single or double doors

Features

- ◆ Slim sightlines
- ◆ Tape or gasket glazed
- ◆ Multi point locking and face mounted shoot bolts





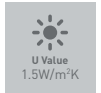

Technical Performance

U Value	1.5 W/m ² K (using sealed unit 1.0 w/m ² K)
Air	Test result pending
Water	Test result pending
Wind	Test result pending
Glass	24mm – 32mm
Typical Sightlines	59mm
Recommended Design Limits	
Max Sash Width	900mm
Max Sash Height	2100mm

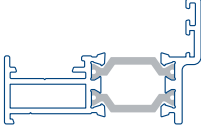
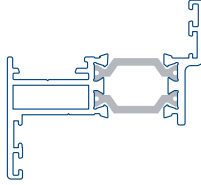
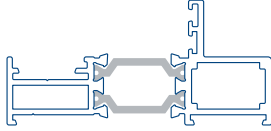
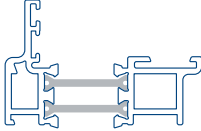
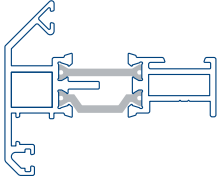
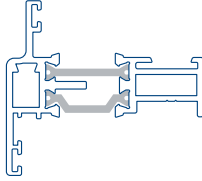
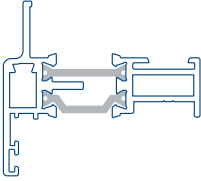
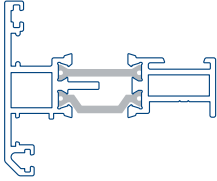
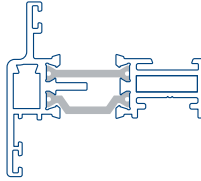
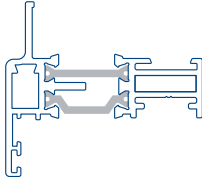
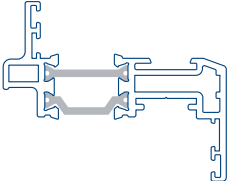
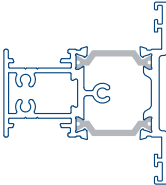
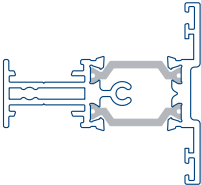
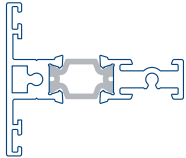
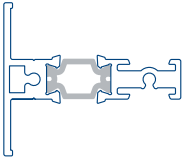
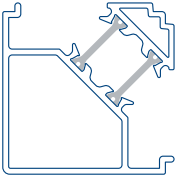
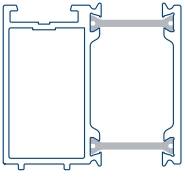
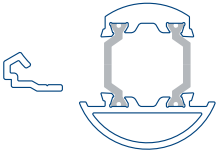
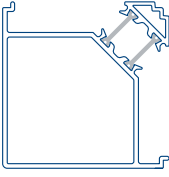
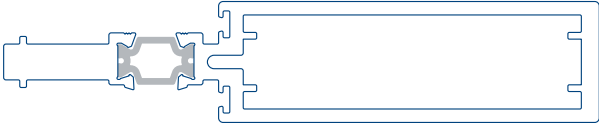
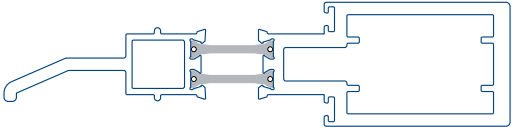
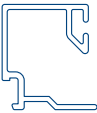

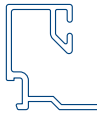
Profile Chart

Section details for all window and door system profiles. Not to scale.

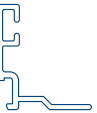
Outer Frame	<p>W20015 Outer Frame</p> 	<p>W20016 Odd Leg Outer Frame</p> 	<p>W20017 70mm Outer Frame</p> 	<p>W20018 Internally Beaded Fixed Light Outer Frame</p> 			
Window Sashes	<p>W20024 Vent</p> 	<p>W20025 Vent</p> 	<p>W20026 Vent - tape glazing</p> 	<p>W20028 Vent</p> 			
Door Sashes and Reverse Adaptor	<p>W20027 Open Out Door Sash</p> 	<p>W20127 Open Out Door Sash Tape Glazed</p> 	<p>W20125 Open In Door Sash</p> 				
Transoms/Mullions	<p>W20034 Transom/Mullion</p> 	<p>W20035 Transom/Mullion</p> 	<p>W20037 Door Transom</p> 	<p>W20137 Door Transom - tape glazing</p> 			
Corner Post and Extensions	<p>ETC047 90° Corner Post</p> 	<p>ETD058 42 mm Head Extension</p> 	<p>W20065 Bay Pole Adaptor</p> 	<p>W20069 Bay Pole</p> <p>W20066 Bay Pole Adaptor</p> <p>ETC048 90° Corner Post</p> 			
Couplers	<p>W20054 Coupler/Mullion</p> 		<p>W20486 Horizontal Coupler</p> 				
Beads	<p>ETC370 Square Bead 24mm Glazing</p> 	<p>ETC364 Chamfered Bead 24mm Glazing</p> 	<p>ETC371 Square Bead 28mm Glazing</p> 	<p>ETC375 Chamfered Bead 28mm Glazing</p> 	<p>ETC377 Square Bead 32mm Glazing</p> 	<p>ETC379 Chamfered Bead 32mm Glazing</p> 	<p>ETC376 Square Bead 36mm Glazing</p> 

W20110
Tilt & Turn Outer Frame

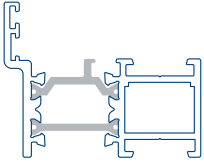

W20029
Vent

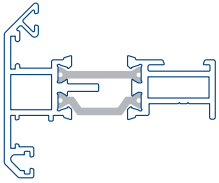

W20122
Externally Beaded Sash

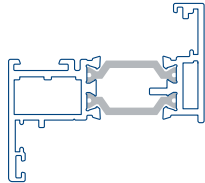

W20120
Tilt & Turn Sash

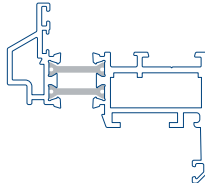

W20126
Sash With Eurogroove

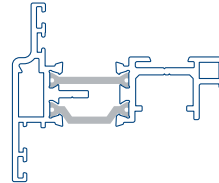

W20047
Reverse Adaptor

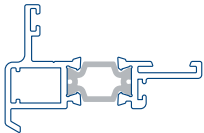

W20147
Reverse Adaptor - tape glazing

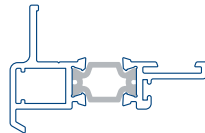

W20048
Meeting Stile

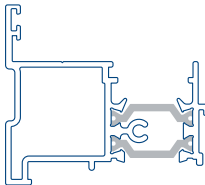

W20045
Pivot Adaptor

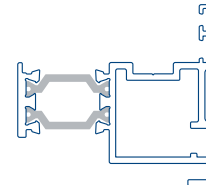

W20038
Door Lock Housing

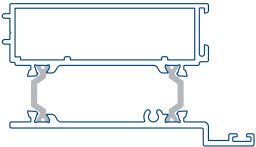

W20138
Door Lock Housing - tape glazing

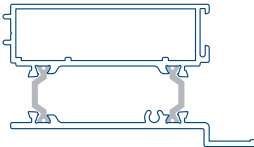

W20130
Tilt & Turn Transom/Mullion

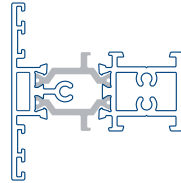

W20032
Narrow Transom with Drip

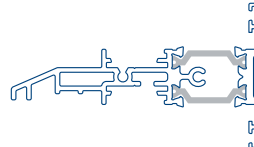

W20039
Wide Transom with Drip

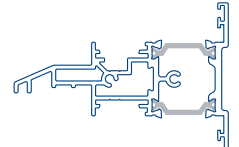

DV515
42mm Head Extension

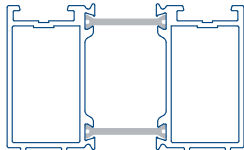

W20165
25mm Astragal Bar



W20166
41mm Astragal Bar



W20175
Threshold Infill



W20487
Vertical Coupler

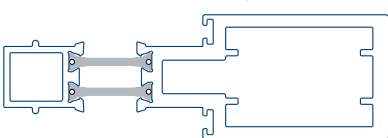

W20488
Horizontal Coupler

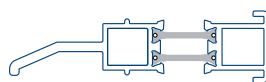

W20489
Vertical Coupler

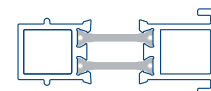

ETC366
W20122 28mm Bead



ETC378
W20122 24mm Bead



ETC381
W20122 24mm Bead



W20168
24/28mm Internal Bead



W20170
28mm Internal Bead



W20174
24mm Internal Bead

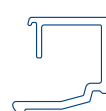

W20178
28mm Internal Bead

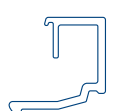

Section Drawings: Casement Window

Examples of Typical Sections

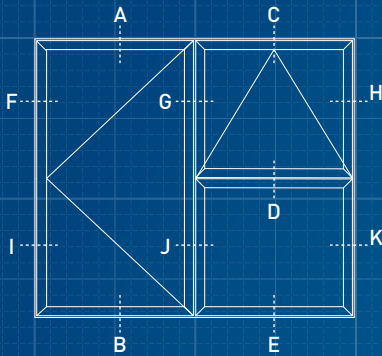

VERTICAL VIEWS

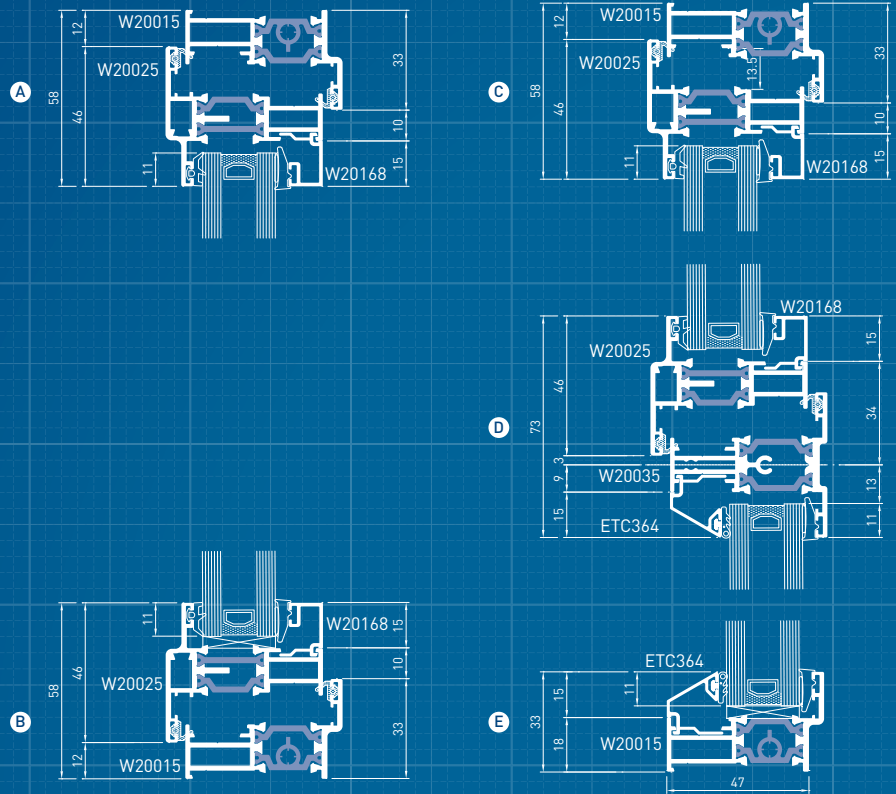

HORIZONTAL VIEWS

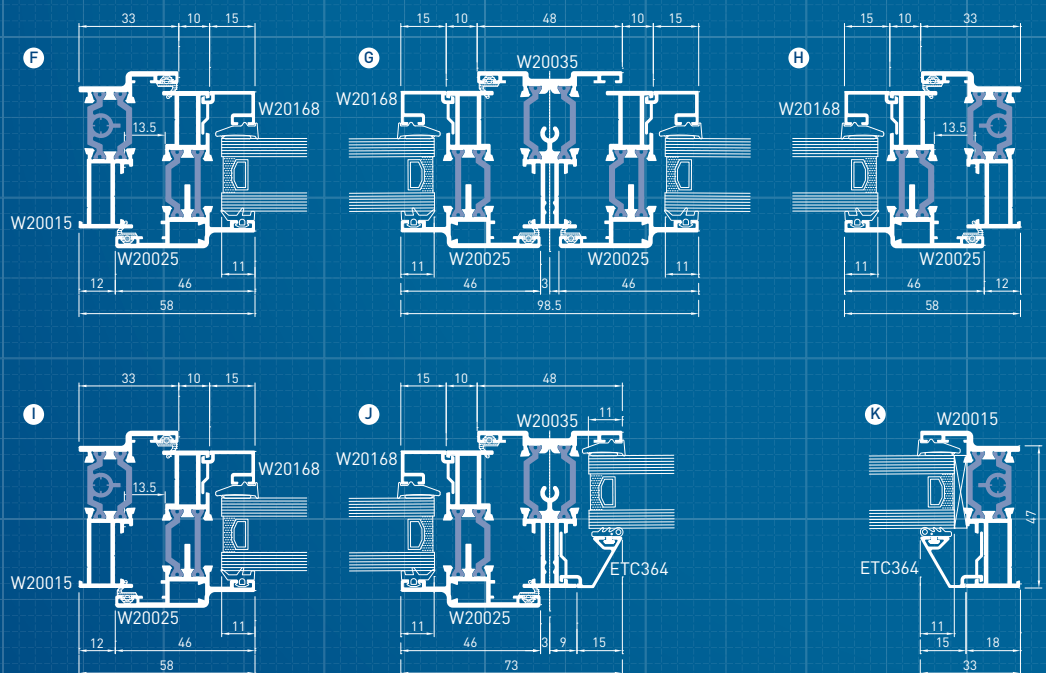

smart
architectural aluminium

Casement Windows

Traditional casement windows are ideal for both residential and commercial applications. Frames can be manufactured in a wide variety of configurations and accept a range of hardware and locking options. Casement windows offer good ventilation and light ingress.

Section Drawings: Tilt & Turn Window

Examples of Typical Sections

VERTICAL VIEWS

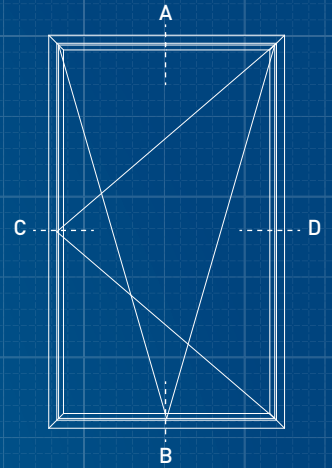
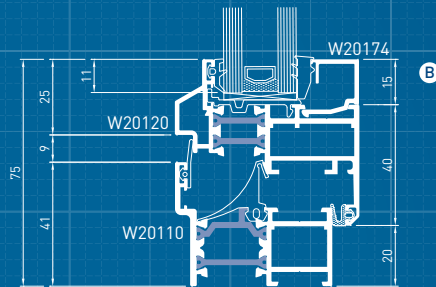
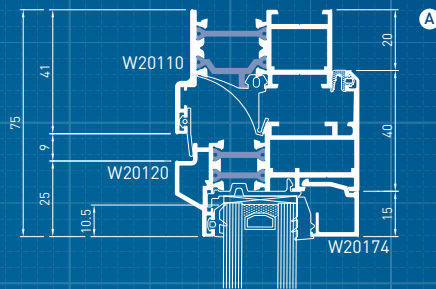

HORIZONTAL VIEWS

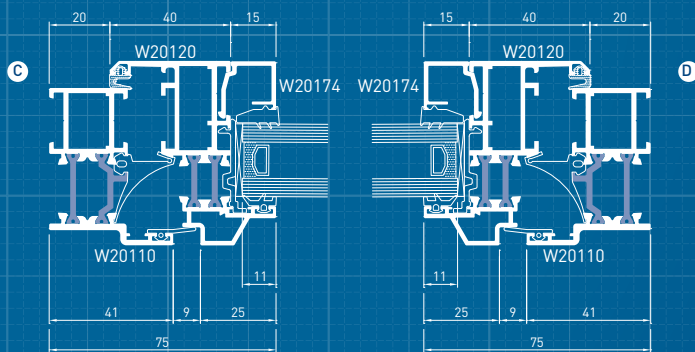

smart
architectural aluminium

Tilt Turn Windows

A tilt turn window opens in two ways, either by an inward opening side hung operation allowing easy cleaning or egress from the window, or by tilting inwards from the top of the sash which provides ventilation whilst ensuring safety and security.

Section Drawings: Double Door

Examples of Typical Sections

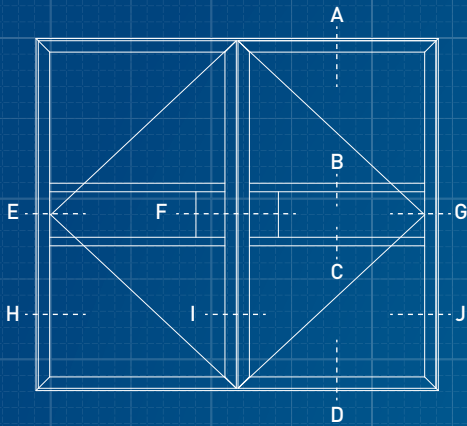

HORIZONTAL SECTION THROUGH LOCK

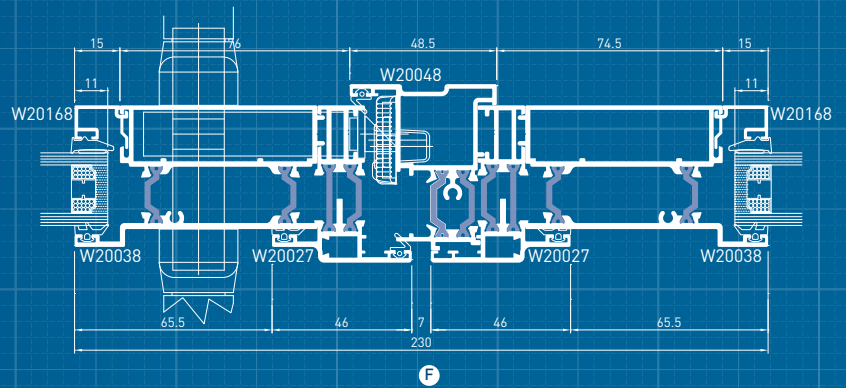
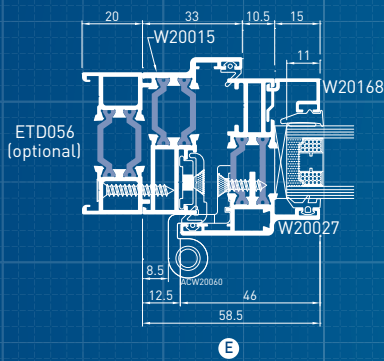

HORIZONTAL VIEW

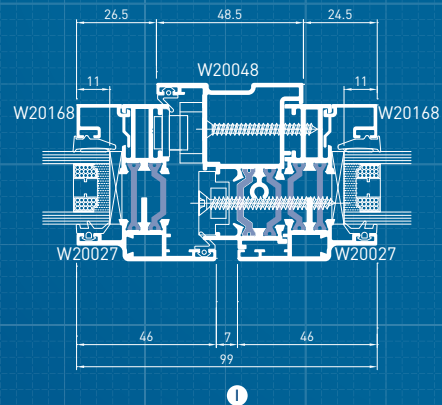
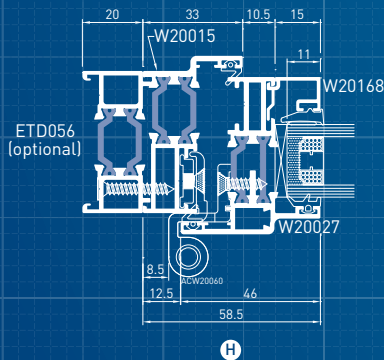

Note: Diagrams not to scale.

VERTICAL VIEW

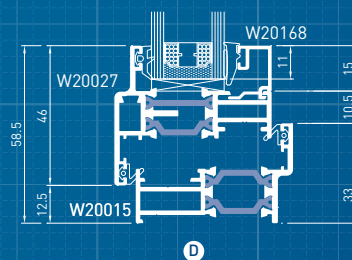
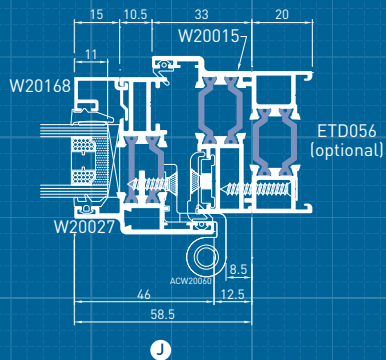
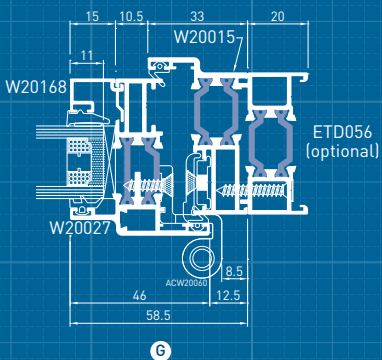
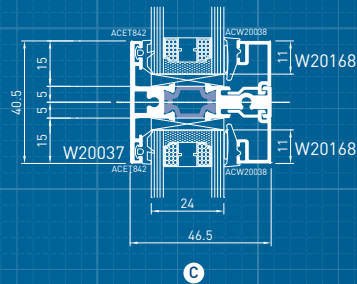
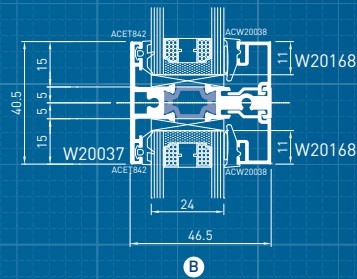
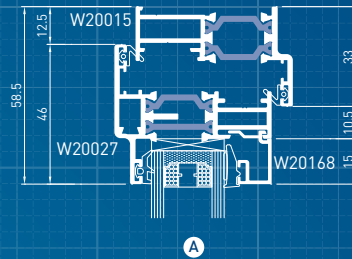

smart
architectural aluminium

Balcony Doors

Alitherm Heritage doors are ideal replacements for steel balcony-type doors on heritage applications such as building renovation or apartment conversions.

Section Drawings: Frame Coupling Options

Examples of Typical Sections

VERTICAL COUPLING OPTIONS

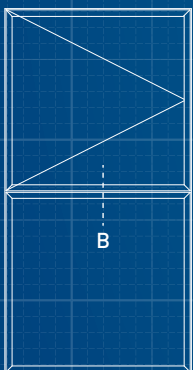
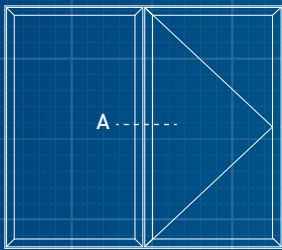
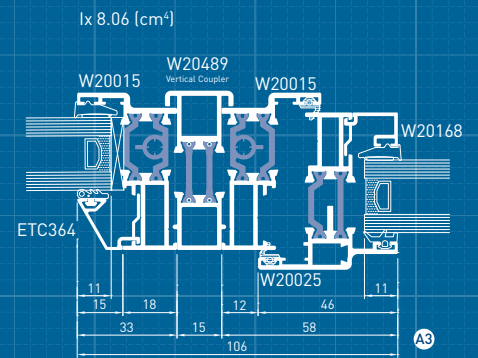
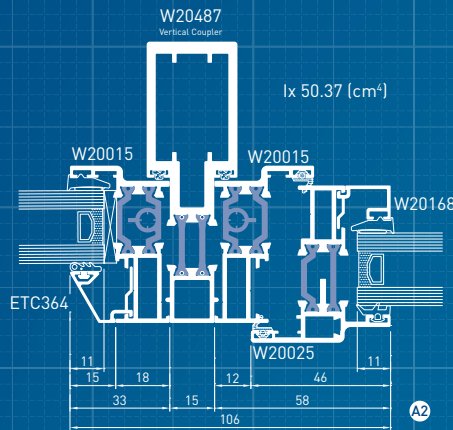
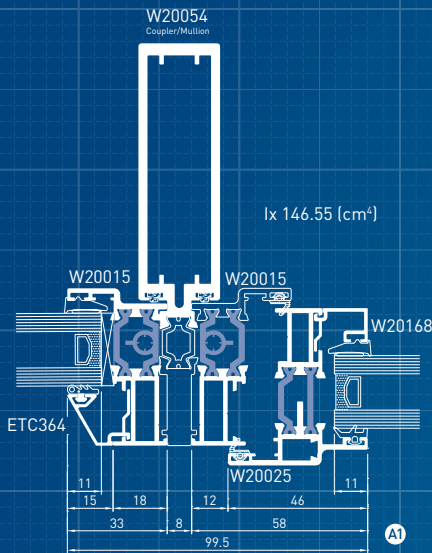

HORIZONTAL COUPLING OPTIONS

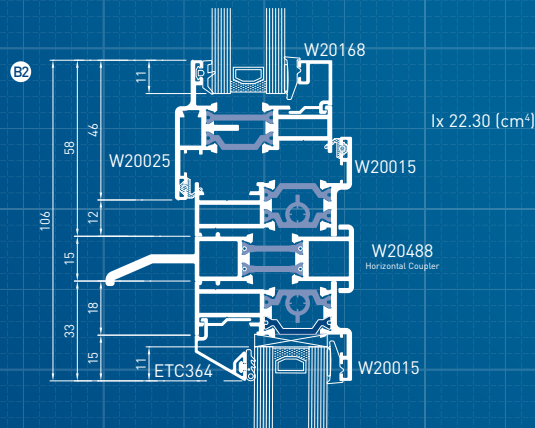
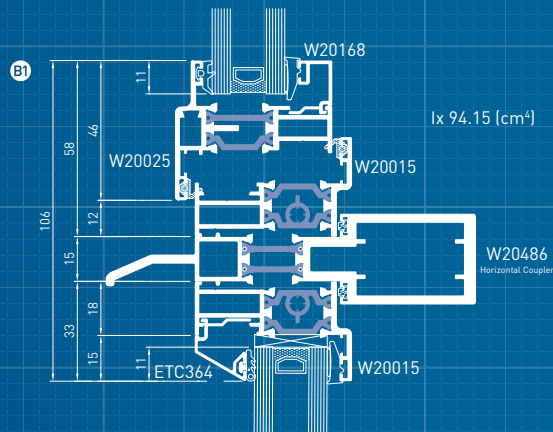

Note: Diagrams not to scale.

Case Study: Payne Road

Location
Payne Road
East London, EC1A 1BB

Architect
Stockwool
19 Hooper St, London E1 8BU

Main Contractor
Galliford Try
Cowley Business Park, Uxbridge



Summary

Located on the edge of the Olympic Park in East London, and on the site of a former chocolate factory and warehouse, this mixed residential and commercial development consists of 158 one and two bedroom apartments – and features studios for local artists, film makers and designers.

To retain the design style of the original structure, which featured steel windows, green polyester powder coated Smart Alitherm Heritage windows were specified for the refurbishment project, with a combination of casement, top-hung and side-hung units installed. On the building's front elevation, arch-headed windows were set back into the original brickwork reveals to maintain the building's traditional aesthetics. Completing the project, Smart's

commercial door and framing system was used for the main entrance on the ground floor and the company's Visoline doors and tilt and turn windows were installed in to a new steel frame extension constructed on the building's roof to provide additional accommodation.



The images, drawings and data shown in this brochure are for illustrative purposes only and are not binding in detail, colour or specification. We reserve the right to make changes to the product specification as technical developments dictate and without prior notice. We recommend that the user ensures that they are satisfied the product meets their requirements prior to purchase.

The 'Smart' logo and the 'Smart Spark' icon are registered Trade Marks of Smart Systems Ltd. ©Smart Systems Ltd 2014