

Customer:- Barr Build Ltd.
 Job Number:- J4333
 Job:- FW007
 Site:- Judges House.
 Drawings By:- Hawker Joinery
 Author:- Simon Hodges
 Date:- 15/01/2024
 Drawing Number:- HAW-J4333-Drg 5
 Scale:- 1:2 & 1:8 @ A3
 Description:-
 Timber - Accoya
 Glass - 18mm Clear Toughened Double Glazing,
 Low E, Soft Coat, Argon Gas, White Warm Edge Spacers,
 6.5mm Sightline.
 Paint Finish - Colour to be Confirmed
 Ironmongery - Butt Hinges, Stays and Fasteners.

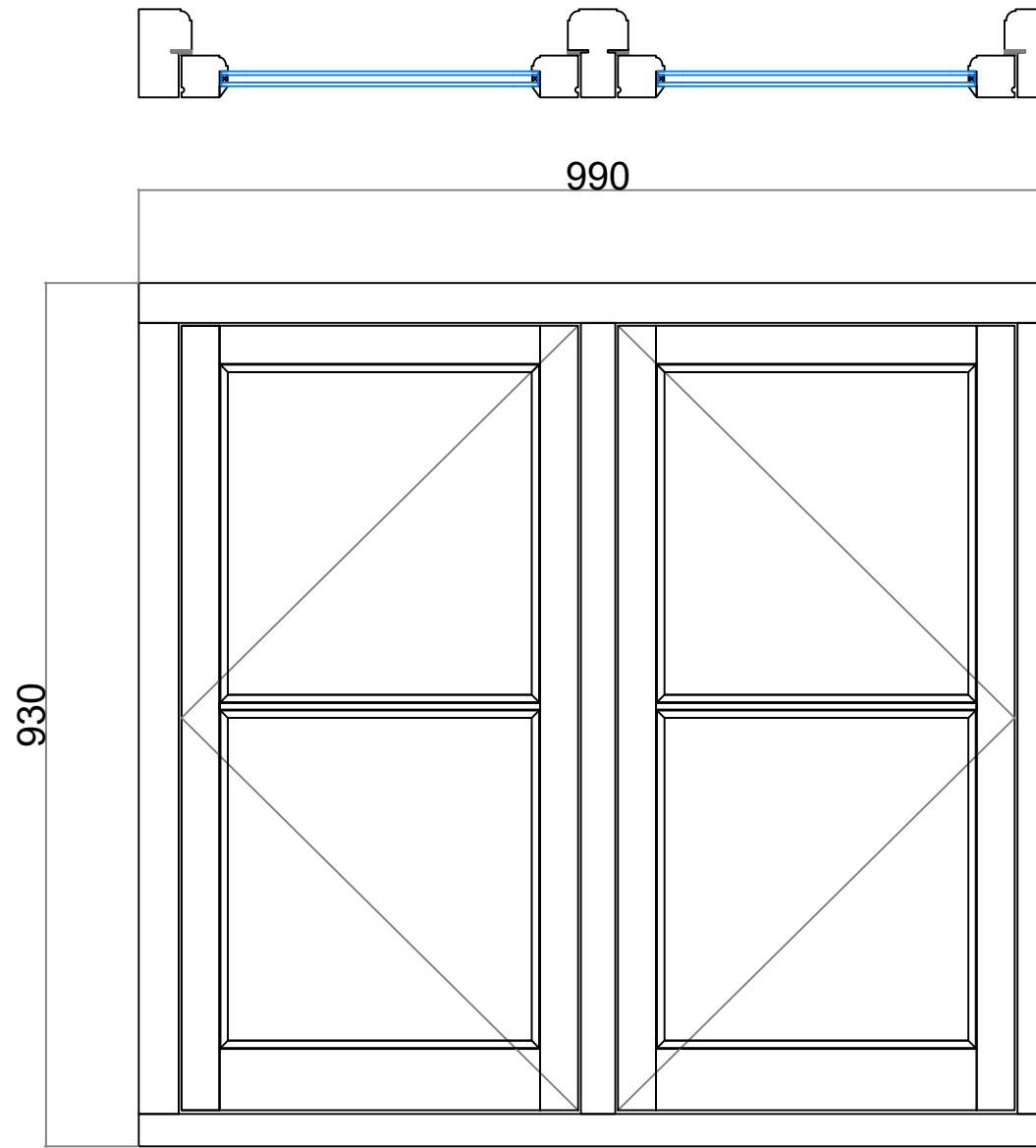

FW007

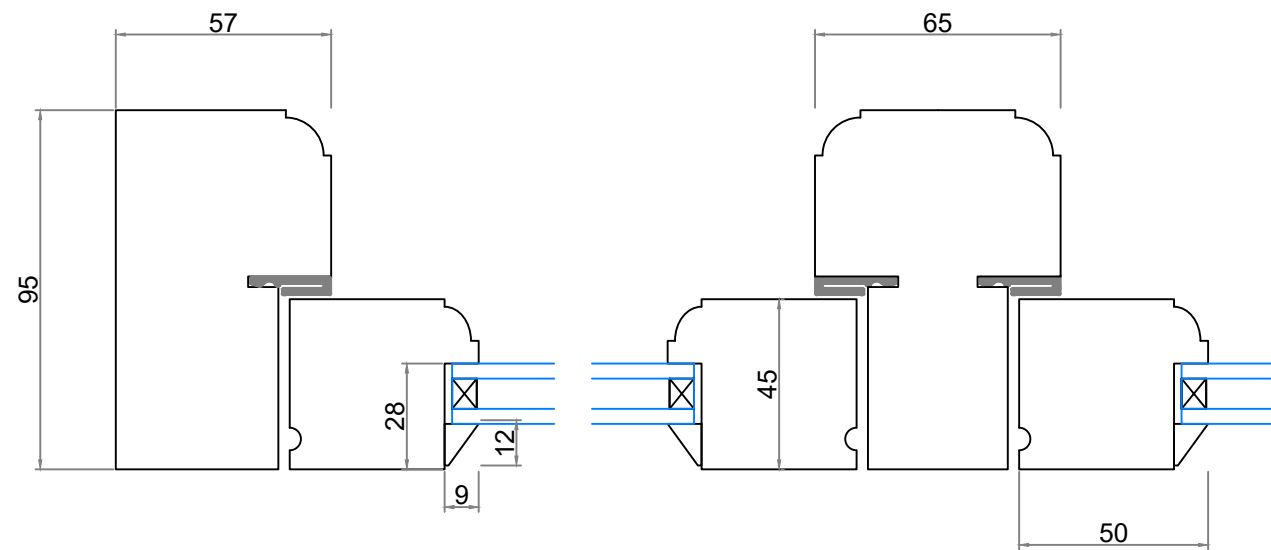
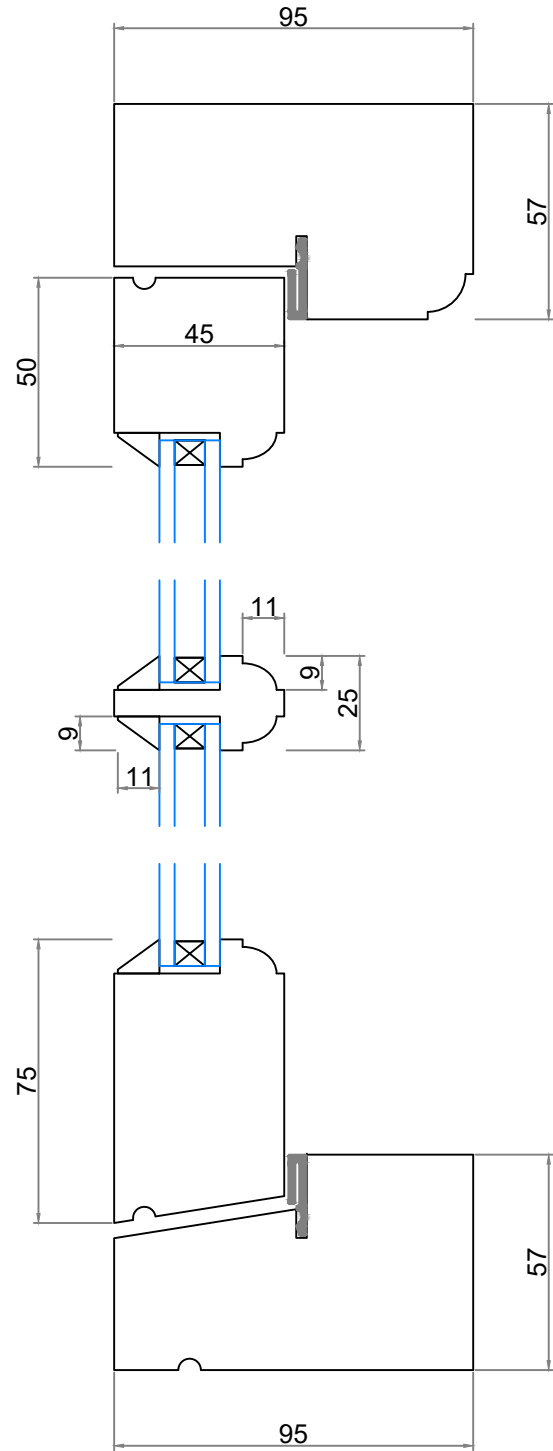