



Timber Window & Door Collection



ALLAN EST. 1811 **BROS.**
Craftsmen of Bespoke Timber Windows & Doors



Craftsmanship That Is Timeless...

At Allan Brothers we have literally generations of joinery expertise at our fingertips, unsurpassed in today's window and door industry

Founded in 1811, our company remains rooted in traditional values and our master craftsmen take immense pride in the quality and meticulous detailing of their work.

Our comprehensive range is all made-to-measure from engineered timber or Alu Clad to suit your home or project.

Our commitment to you

Choosing windows and doors is a major decision that can make a big difference to the appearance of your property. That is why we work closely with our customers, so that you receive the most appropriate designs and detailing for your home.

For over 200 years, customers have trusted us for our expert advice and commitment to service, prompt delivery and a quality that will endure.

We hope you will too!

Contents

Experience You Can Trust	4	Alu-Clad Timber Windows	20
Warranties	4	Our Door Range	26
Compliance	5	French and Single Doors	28
Member Of The Guild Of Master Craftsmen	6	Patio Sliding Doors	30
Our Window Range	7	Bi-Folding Doors	31
Timber Casement Windows	8	The Scotdoor Collection	32
Timber Sliding Sash Windows	14	Technical Drawings	42

Experience You Can Trust

With our vast experience, we are often asked to make bespoke windows and doors for all building styles – even historic castles!

You'll be amazed to see the authentic old-style timber joinery features and traditional hardware we still use – as well as the stunning ultra-modern Alu Clad window and door designs that we manufacture for contemporary new builds.

Our products are made to today's rigorous performance standards, with a range of advanced energy-efficient glazing options. Whatever your preferred style, you can rely on your Allan Brothers windows and doors to give good service for many years to come.



Warranties

Our wood is carefully sourced from Scandinavia, where the timber is renowned for being strong, durable and with a life expectancy of over 60 years!

In addition to this, we treat our timber with industry standard factory applied finishes that contain Eco Friendly solvent free preservatives, ensuring maximum longevity of your windows and doors.

This is why, subject of course to appropriate installation and maintenance, we can confidently provide you with market leading warranties throughout our product range, resulting in your ongoing reassurance that you have made the correct decision when choosing Allan Bros Windows and Doors!

(Please see our website for our installation and maintenance guide, or please feel free to call our commercial team for information).

Coverage

30 Years

- Rot & Fungal Protection

10 Years

- Paint Finish Warranty on Standard and non-standard RAL Colours
- Glazing Failure Warranty
- Manufacturing Warranty

5 Years

- Ironmongery Warranty
- Stained Finish Warranty
- Black Paint Finish Warranty

Compliance

Secured By Design

Secured by design (SBD) is an official police security initiative, which aims to improve the security of buildings through a recognised standard for all security products, including doors and windows.

Although SBD membership and accreditation is not obligatory, we believe it is the right thing to do for our customers.

In order to help reduce crime and to give you the best reassurance we can that our timber and Alu Clad windows and doors are secure and will help protect your home from criminal and unauthorised entry, we are proud to hold SBD accreditation.



FSC®

The Forest Stewardship Council® (FSC®) is a global certification system, which promotes "environmentally appropriate, socially beneficial and economically viable management of the world's forests".

As we are committed to helping to protect our environment from climate change, and the destruction of landscapes and ecosystems, all our softwood timber comes from certified FSC® managed forests in Northern Scandinavia.

That way you know that the wood we use is from sustainable and responsibly managed sources and that our traditionally crafted timber and Alu Clad windows and doors are carbon neutral and absorb more CO2 from the atmosphere than they produce.

We believe that the FSC® way is a better way to do business.

Part Q / PAS24

Approved Document Part Q / PAS24 is a building industry security regulation, designed to prevent unauthorised access into new dwellings, houses or flats and apartments within a building from burglars.

It also applies to existing buildings, such as barns, or warehouses, which are being converted to residential purposes.

To meet this Standard, doors and windows installed in new residential buildings must be sufficiently robust and fitted with appropriate hardware and have proven security performance such as 2016: PAS 24 certification.

You can rest assured that all Allan Brothers timber and Alu Clad windows and doors for new build have been tested and hold 2016: PAS 24 certification in accordance with Part Q.



Member Of The Guild Of Master Craftsmen



Anyone who has met us knows that quality and craftsmanship is at the very heart of who we are and what we do

Over our 200 years of trading, our core philosophy of going the extra mile and "getting it right" for our customers has motivated generation after generation of joiners and tradesmen at our factory in Berwick upon Tweed.

It can be seen in the exquisite quality of our carefully crafted timber and Alu Clad windows and doors and in our excellent customer service.

That is why we are proud to align ourselves with the Guild of Master Craftsmen. As the UK's most established and well-respected trade association, the Guild's emblem stands for skill, integrity, and expertise. All members have been rigorously assessed and have truly earned the right to be called "master craftsmen".

As Guild members, we are committed to upholding the highest professional standards and to flying the flag for modern-day craftsmanship!





Available in a range of classical and contemporary styles and designs

Our Window Range

Our range of high-performance timber windows combine traditional craftsmanship with the highest levels of performance

As standard, our fully glazed windows are supplied with multi-point locking and easy clean hinges, factory-finished in a choice of 10 colours or 3 wood stains - or upgrade to any RAL colour.

An extensive range to meet your needs

We produce Flush and Stormproof Timber Casements, in addition to Vertical Sliding Sash variations.

For modern projects, our Aluminium Clad window range, comprising of Tilt & Turn and casement options, offers reduced maintenance, high thermal efficiency and an even longer service life.

Our windows are rigorously tested to the latest European and British safety and performance standards, accredited by independent third parties and Secured by Design.

Timber Casement Windows

As all properties are different, we offer two ranges of timber casement windows with a wide variety of design and performance features to suit your needs

All our casements are made-to-measure, meticulously crafted and easily exceed the latest British and European safety and performance standards. Whether you are looking for traditional styling, exceptional weather resistance, high thermal efficiency, or enhanced security, we know we can supply just the right casements for your home and your lifestyle.

Our casement windows are available as Flush or Stormproof casements. They can be either internally or externally beaded.



Flush Casements

Our popular Timber Flush casements have a classic beauty and simplicity that enhances modern homes whilst also complementing older traditional and heritage properties.

Made-to-measure from sustainably sourced softwood timber, the flush design has a hand crafted, sleek look with decorative internal mouldings, internal or external beading, and a choice of glazing bars and traditional hardware.



Flush casement - internally beaded



Flush casement - externally beaded

Storm Casements

Timber Storm casement windows are extremely strong and stylish, providing outstanding levels of energy efficiency, acoustic performance and security credentials.

Designed to withstand the harshest weather conditions, they are made from durable, sustainably sourced timber from Scandinavia, featuring high-performance glazing as standard.

Available in both top hung and side hung configurations, they combine practicality with a high level of craftsmanship that can be customised with either internal or external beading, decorative internal mouldings on the sash, frame and glazing bars for a touch of elegance.



Storm casement - internally beaded



Storm casement - externally beaded

Opening Functions

The below product renderings detail the opening method only and are not fully accurate depictions of the product range stated.



Fixed Windows

Fixed window units can't be opened. They are often used as sidelights or top-lights to doors and windows to generate additional light or adjacent to an opening sash to achieve a specific architectural design.

Fixed windows are available in both double & triple glazing.



Fully Reversible

The fully reversible opening function can reverse on concealed hinges to allow for cleaning from the inside. The hinges open to a maximum of 170 degrees.

The fully reversible opening function is available in double & triple glazing.



Side Guided

The side guided opening function has an opening position of up to 90 degrees on concealed friction hinges, which also allows for easy cleaning from the inside.

The side guided opening function is available in double & triple glazing.



Side Hung (System 2000 only)

Side hung windows open out on visible butt hinges.

The side hung opening function is available in double & triple glazing.



Tilt and Turn

Tilt and turn windows give you the option of using the tilt function to allow ventilation into your room. You can also open the window inwards, providing easy cleaning from inside.

The Tilt and Turn opening function is available in double & triple Glazing.



Top Guided

Top guided windows open out on concealed friction hinges.

The top section of the frame slides down and the bottom of the sash is pushed out giving highly effective ventilation.

The top guided opening function is available in double & triple glazing.



Bars

Developed to achieve a minimum of heat loss our timber casements are double-glazed with a spacer bar located between the two panes. A bar profile is then bonded to both sides of the window. Bars are available in a 25 mm, 40 mm or 56 mm profiles.

FLUSH – INSIDE



Flush 25 mm bars

FLUSH – OUTSIDE



Flush 25 mm bars



Flush 40 mm bars



Flush 56 mm bars



Flush 40 mm bars

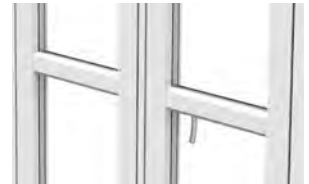

Flush 56 mm bars

STORM – INSIDE



Storm 25 mm bars

STORM – OUTSIDE



Storm 25 mm bars



Storm 40 mm bars



Storm 56 mm bars



Storm 40 mm bars



Storm 56 mm bars



*Total peace of
mind with timber
guaranteed for
decades*



Timber Sliding Sash Windows

Our bespoke sliding sash timber windows have a traditional character, charm and beauty, which blends well with old style properties and adds a classic elegance to modern homes

These finely crafted windows can be internally or externally beaded according to preference and can be further customised with a wide range of period details including stylish arched frames, decorative bars and various horns and hardware options.

We offer a choice of two distinct opening systems to suit your home and lifestyle:

- Cords and Weights – a very traditionally styled pulley mechanism often found in old houses, with the old-fashioned heavy-duty cords and weights within the box frame.
- Spiral balance – an easy-to-use mechanism with pre-tensioned springs concealed within the timber frames, ideal for smaller reveals in more confined areas.
- Traditional appearance
- Modern manufacturing processes
- Internally and externally glazed options

Opening Functions



Cords and Weights

Used extensively in Britain since the seventeenth century, sash windows can add charm to any building, old or new. Achieve a truly stunning classical effect with a window operated by cords & weights.

The sashes slide up and down using traditional pulleys with heavy duty cords and weights. Simplex fittings can be fitted to the bottom sash, allowing it to open on butterfly hinges to facilitate cleaning.



Spiral Balance

Ideal for smaller reveals. Combining period style with modern technology, spiral balance sash windows are a great alternative for smaller reveals.

The sashes slide by means of partially hidden pre-tensioned springs, with a smooth, easy-to-use mechanism that's simply a joy to operate!



Horns

Horn options A / B / C / D are available on internally beaded top sashes.
Horn option A is available on externally beaded top sashes.



Horn option A



Horn option B



Horn option C



Horn option D

Bars

Developed to achieve a minimum of heat loss our Sliding Sash Windows are double-glazed and can be fitted with 25mm spacer bars.

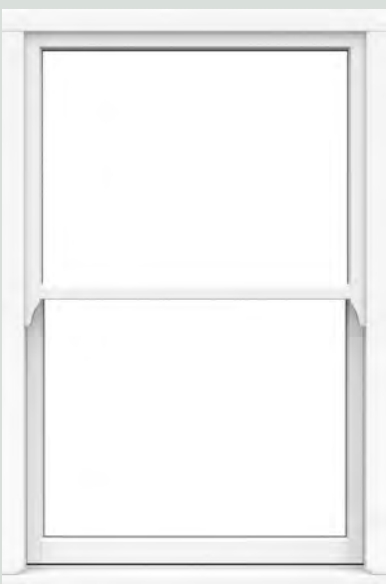

Spiral balance, non bar



25mm bonded bars



25mm bonded multi bars

Standard Colours & Stains – Timber Windows

Our standard colour and stain choices – many more available

Standard RAL Finishes

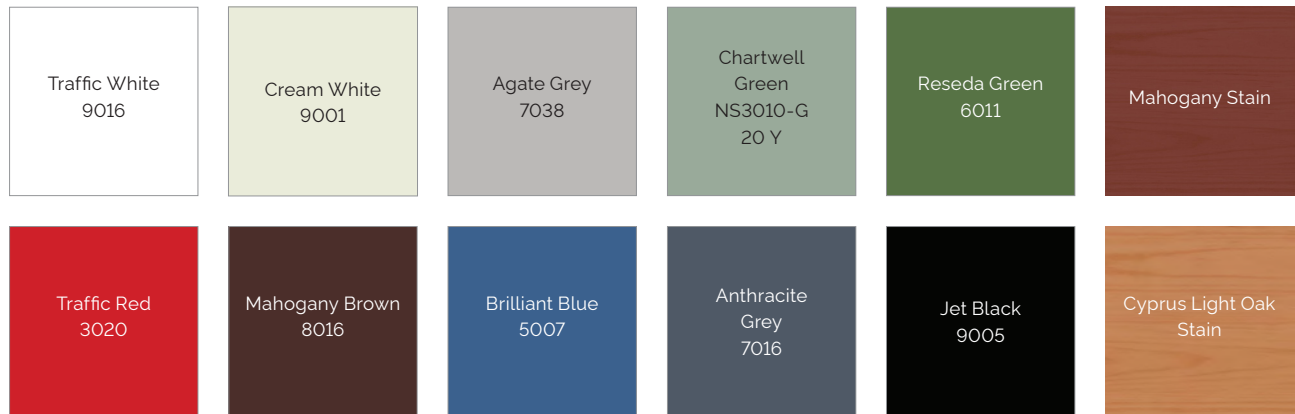

RAL Colour Upgrade

In addition to our standard colour palette, our windows and doors are available in any colour from the RAL Classic range providing a vast selection of colours from which to choose.

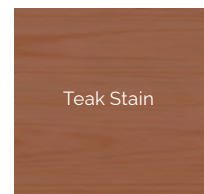

Glazing – Patterned Glass Options

For reasons of either privacy or style our patterned glass provides a range of attractive options. From classic to contemporary we offer a textured glass to suit most requirements you may have.



Stippolite



Satinovo



Cotswold

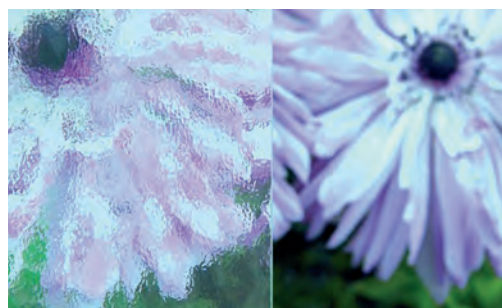

Minster

Timber Window Hardware



Cranked Handles

White, Graphite, Black, Antique Black, Chrome, Gold, Brown



Monkey Tail Handles

Chrome, Gold, Graphite, Antique Black



Tear Drop Handles

Chrome, Gold, Graphite, Antique Black



TV90 Air Vent

White, Brown, Satin Chrome



Standard Hardware for VSS – High Performance Range

Contemporary Range

Available in Polished Chrome, Gold, Graphite



The Heritage Range

Available in Polished Chrome, Gold, Graphite





Alu-Clad Timber Windows

Aluminium Clad timber windows and doors – a highly durable, low-maintenance, versatile solution for domestic and commercial applications.

With Aluminium Clad timber, the added layer of protection and finish allows windows and doors to withstand even the most severe conditions and easily adds another 10 years to its life expectancy.

Excellent insulation and minimal maintenance

Our Alu-Clad timber window and door ranges are so energy efficient that they can deal with the harshest Scandinavian and Scottish weather conditions. The combination of superior craftsmanship, thermal performance and long-term durability make Alu-Clad windows and doors ideal for modern new build or refurbishments with a focus on energy efficiency. With a solid timber frame and Alu Cladding externally, our windows deliver the beautiful look inside that only timber can. A wide assortment of colours, glazing and opening functions allow you to customise them to meet your exact needs.

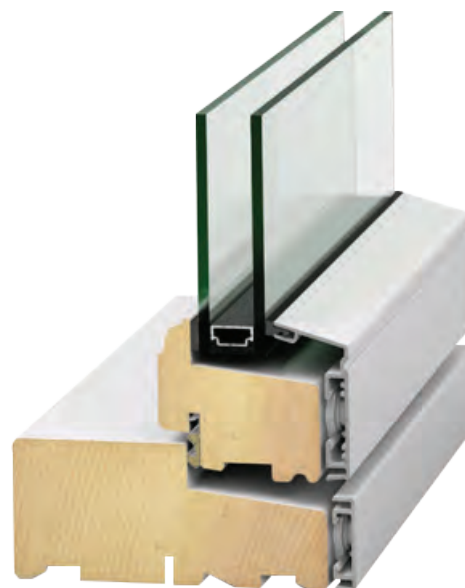

Opening Functions



Fixed Windows

Fixed window units can't be opened. They are often used as sidelights or top-lights to doors and windows to generate additional light, or adjacent to an opening sash to achieve a specific architectural design.

Fixed windows are available in both double & triple glazing.



Fully Reversible

The fully reversible opening function can reverse on concealed hinges to allow for cleaning from the inside. The hinges open to a maximum of 170 degrees.

The fully reversible opening function is available in double & triple glazing.



Side Guided

The side guided opening function has an opening position of up to 90 degrees on concealed friction hinges, which also allows for easy cleaning from the inside.

The side guided opening function is available in double & triple glazing.



Side Hung

Side hung windows open out up to 90 degrees on visible butt hinges with friction brake.

This allows the sash to hold open in any position. This type of window can provide fire escape if necessary.

The side hung opening function is available in double & triple glazing.



Tilt and Turn

Tilt and turn windows give you the option of using the tilt function to allow ventilation into your room. You can also open the window inwards, providing easy cleaning from inside.

The Tilt and Turn opening function is available in double & triple Glazing.



Top Guided

Top guided windows open out on concealed adjustable hinges. The top section of the frame slides down and the bottom of the sash is pushed out giving highly effective ventilation.

The top guided opening function is available in double & triple glazing.



Profile Options

Classic or Softline (modern) profiles are available to suit your preferred interior finish.



Classic



Softline

Vents

Trickle vents are a safe and easy way of achieving air ventilation in a room. Vents are available in three colours: white, aluminium, or white/aluminium.



Clickvent Trickle Vent



Clickvent Trickle Vent



Clickvent Trickle Vent closed



Clickvent Trickle Vent opened

Bars

Developed to achieve a minimum of heat loss our Alu-Clad casements are double-glazed with a spacer bar located between the two panes. A bar profile is then bonded to both sides of the window.

Bars are available in a 25 mm, 42 mm or 60 mm profiles.



25 mm bar (front)



25 mm bar (Back)

Alu-Clad Window Hardware



Alu-Clad Flush Casement
Satin & White



Tilt and Turn Handles
Satin



42 mm bar (front)



42 mm bar (Back)



60 mm bar (front)



60 mm bar (Back)

Standard Colours – Alu-Clad Windows

Our standard colour choices – many more available

Standard RAL Finishes



*The benefits of timber with
even greater durability
and insulation*

Our Door Range

Timber Doors boasting truly outstanding weather performance and high-security credentials, available in a range of traditional and contemporary designs

Quality and durability that only timber can provide

From Timber Scotdoors and French Doors to Patio Sliding and Bi-folding configurations, our range of timber doors are hand-crafted without compromise. Using the highest quality Engineered softwood, we create high-performance, beautiful entrances that always add a touch of class.

Constructed to the same exacting standards as our windows, with timber guaranteed for decades, our door sets incorporate a host of technical innovations for absolute peace of mind. Our high-specification doors are also available 'Secured by Design'.

Something for everyone

Allan Bros' stunning contemporary timber doors are available in a range of styles and sizes to meet your every need. Our Scotdoor range alone comprising of 27 different designs and all our door ranges are available in 10 standard RAL colours, so there's something for everyone!





*To make a grand entrance,
nothing but timber will do*



French and Single Doors

Allan Bros' traditional hand-crafted Timber Doors make the great outdoors the star of the show

Available in a range of styles from contemporary to classical, our timber doorsets comply with industry standard energy efficiency. Combining tried and tested Scandinavian technology with British craftsmanship, keep any home safe and warm, at the same time, giving outstanding kerb appeal.

High performance, made-to-measure doors

Coming with three point high security locking system as standard, our doors provide peace of mind, ensuring your home is safe. Weatherproof finishes look great and give you the utmost protection from the elements.

Manufactured to the same exacting standard as our high performance timber windows, our doorsets are supplied fully assembled including frame, doors, glazing, high security multi-point locking and factory-finished in a choice of 10 colours or 3 wood stains - or upgrade to any RAL colour.

Looking for something unique?

Create the star of any entrance and tweak our single entrance doors to create a bespoke design. Add extra transoms and mullions along with multiple glazing options to create a truly unique door!





Create a unique, stunning entrance to any home!

Standard Specification

- Engineered softwood
- Low aluminium threshold
- Multi-point locking system
- Optional Astragal bar upgrade available
- Hardware to PAS24/Doc Q as standard
- 6.8mm laminate required for PAS24/Doc Q
- Full height glass and 3 half glazed panel options
- Clear toughened 'Low E' glass
- Choice of 10 RAL colours and 3 wood stain finishes
- Optional sub sole and cill extensions
- All timber FSC® certified

Patio Sliding Doors

Excellent weather performance with a range of combinations and flexible features

Versatile for use in domestic and commercial applications

Perfect for large openings that demand unbroken sight-lines, our patio sliding doors are available in a wide range of sizes with high thermal insulation and security locking.

Smooth operation of the large panes is assured by lowering the rollers to lift the door off its seals, allowing it to slide back with ease. Frames are supplied beautifully finished in a choice of factory paints or choose from any RAL colour for that personal touch.





Open up any room and create an unmistakable wow factor

Bi-Folding Doors

Bi-folding doors are a sure-fire way to elevate any living space – open, shut, or somewhere in between, they never fail to impress

Made-to-measure to suit your needs

For the ultimate in beautiful, high-performance design, Allan Bros Timber Bi-fold Doors are second to none. Our bi-folds are highly secure, superbly insulated and can meet the requirements of Secure by Design.

Available in a wide range of configurations and optional extras, our bi-folds will enhance any room, completely transforming both interior and exterior design.

Expand your living space in an instant

Nothing beats the real thing and engineered timber is the material that always delivers on quality for your bi-fold doors. Add to that our years of expertise and craftsmanship, and you'll be amazed by the effect we can create.

For saving space and opening up the room, bi-fold doors are an elegant and impactful solution, illuminating any living space and creating an indisputable wow factor!

The Scotdoor Collection

The Scotdoor is the result of over 200 years' experience in the joinery industry culminating in the ultimate entrance door

With 27 door designs to suit all needs and decorative glass options to choose from, when combined with excellent Thermal and Security performance, the Scotdoor is perfect for New Build and Renovation projects.

Traditional and contemporary designs

Combining tried and tested Scandinavian technology with traditional British styling, Scotdoors give exceptional performance against the weather and a high level of resistance to forced entry.

Manufactured to the highest standards using high-end CNC equipment to achieve the exact design and sizes requested, the composite door slabs and timber frames are made-to-measure and built to your specification. Using one of the leading coating systems in the industry, our doors are supplied fully factory-finished, allowing us to offer market leading warranties.

Supplied fully assembled, including frame, door, glazing, locks and handles, allowing for a quick and easy installation, the Scotdoor range is available with PAS24:2016 certification and is registered with 'Secured By Design'.

Door Construction

- Extruded polystyrene rigid foam insulation plate (XPS)
- Vertical veneer
- Aluminium stabilising sheet, security and moisture barrier
- Vertical veneer
- Horizontal veneer
- 1.5 mm quarter cut veneer for appearance and durability

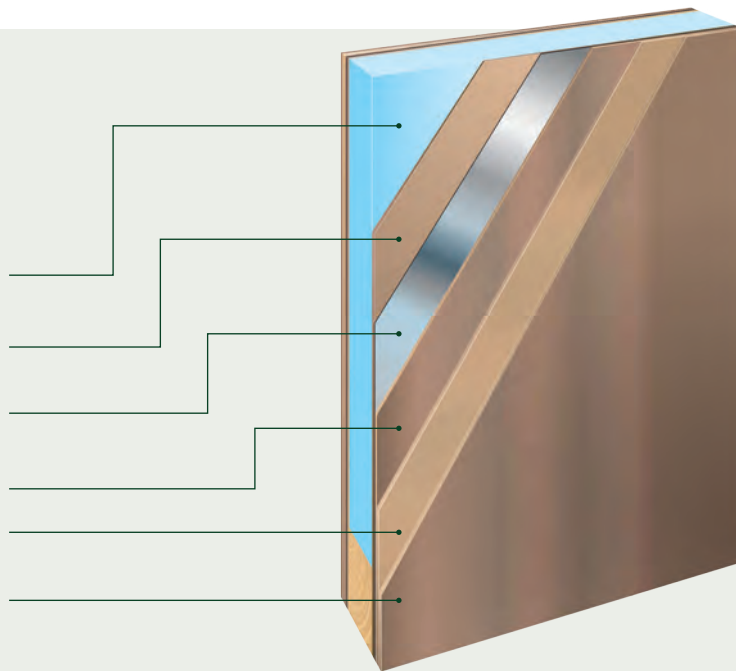

The composite door has a bonded sandwich construction providing a high degree of stability, with the aluminium plates acting as an effective moisture barrier.

The insulating core gives an exceptional U-Value as low as 0.95W/m²k.



*Perfect for New Build
and Renovation projects*

Scotdoor Colour Options



Skye 1



Harris 1



Islay 2



Islay 3



Jura 1



Jura 2



Jura 3

Standard Colours

Alternative RAL colour upgrade available on request.

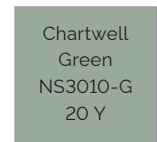



Skye 1 in chartwell green with dorchester glass

Skye 1

The Skye Door provides elegance and simplicity, with a range of glass that exudes quality whilst retaining the classic look and feel of a dual-glazed door.



Featured Glass: Dorchester

Genuine coloured Spectrum Glass with blackened lead combine to create this stunning leadlight design, reminiscent of the Victorian era. Using multi-patented 'Future Unit' technology, you can now have all the benefits of traditional leadlights, with the performance and thermal properties you would expect in a Scotdoor.



Skye 1 in agate grey with caledonia rose glass



Skye 1 in anthracite grey with kensington glass



Skye 1 in beige grey with simplicity glass



Skye 1 in red with red diamonds glass



Harris 1 in beige grey with caledonian rose glass

Harris 1

The Harris Door allows the classic half-glazed option with a traditional panel effect. The elegant glass designs available truly add to the design, bringing privacy and security to your home.



Featured Glass: Caledonian Rose

A masterful floral design, inspired by the work of Charles Rennie Mackintosh, the famous Glaswegian architect. The subtle stippled texture of Mackintosh's famous rose motifs contrast with the etched glass surround, creating a design that is an eye-catching enhancement for any home.



Harris 1 in green with linear glass



Harris 1 in anthracite grey with murano glass



Harris 1 in blue with kensington glass



Harris 1 in gardenia with crystal bohemia glass



Islay 2

The Islay 2 is one of our most popular door designs, with the classic and simple slatted panel effect Glass options add style and character to the door.

Islay 2 in blue with prairie glass



Islay 2 in chartwell green with red diamond glass



Islay 3

An alternative to the rectangular glass, the Islay 3 offers a diamond effect with simplistic and stylish glass options.

Islay 3 in cream with bullseye glass



Islay 3 in green with murano glass



Jura 1

The Jura 1 offers a four pane glazing option that really complements the door. Contemporary styling will add character to any entrance.

Jura 1 in traffic grey with green diamonds



Jura 1 in agate grey with prairie glass



Jura 2

The Jura 2 is also offered in a full height single glazing pane, maintaining the contemporary look with alternative glass designs.

Jura 2 in anthracite grey with murano glass



Jura 2 in traffic grey with tahoe glass

21 additional door designs to choose between

With a number of unique glazing options available for each design.

For further information, visit our website or contact our sales team.



Arran 1



Arran 2



Harris 2



Iona 1



Iona 2



Iona 3



Iona 4



Islay 1



Islay 4



Islay 5



Islay 6



Islay 7



Islay 8



Islay 9



Jura 4



Lewis



Mull



Skye 2



Skye 3



Tiree 1



Tiree 2

Timber Door Hardware

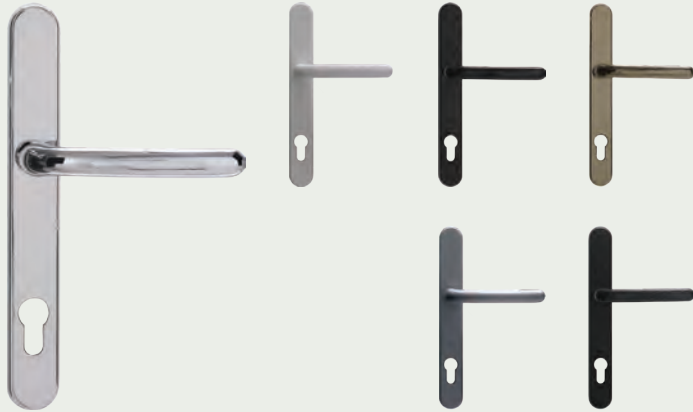

Balmoral Door Handle
White, Black, Chrome, Gold, Satin, Antique Black, Graphite



Balmoral Swan Neck Handle
Chrome, Gold, Satin, Graphite, Antique Black



Oval Escutcheon
Chrome, White, Black, Gold, Graphite, Antique Black



Standard Letterbox
Chrome, White, Black, Gold, Satin, Antique Black, Graphite



Stainless Steel Pull Handle



Brisant Finger Pull
Black, Chrome, Gold

Timber Door Hardware

Hand Crafted Range



Avon Door Handle

Black, Pewter



Cottage Slimline Handle

Black, Pewter



Monkey Tail Handle

Black, Pewter

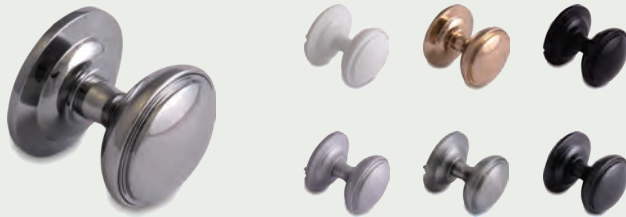

Decorative Door Knob

Chrome, White, Black, Gold, Satin, Graphite, Antique Black



Architectural Letter Plate

Chrome, Gold, Antique Black, Graphite



Bull Ring Knocker

Antique Black, Black, Graphite, Gold, Chrome

Security Cylinder

Our cylinder is possibly the strongest and best locking cylinder on the market. Designed to withstand every type of attack, the cylinder activates lock down mode when under attack, preventing unwanted visitors from gaining access.



Alu Clad Door Hardware

Alu Clad Entrance Doors Handles



Tokyo, Satin



Victoria, Satin



Stockholm, Satin

Alu-Clad French Doors Handles



Non-lockable handle



Lockable handle

Alu-Clad sliding Doors Handles



Handle open position, inside



Handle closed position, inside

Bi-folding Door Handle





*Contemporary styles,
enhancing any building*



The A-series Collection, Stormproof Casement 68mm & 92mm Frame

EXTERNAL GLAZED 68MM FRAME SECTIONS

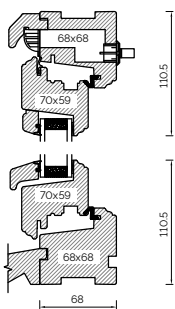

HEAD AND SOLE

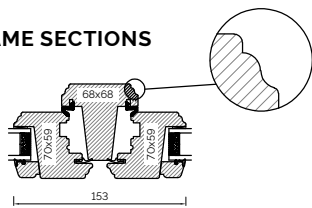

MULLION

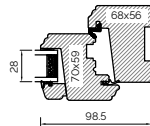

JAMB

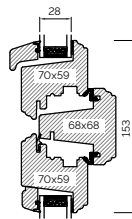

TRANSOM

BONDED BARS

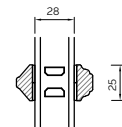

25MM BONDED BAR

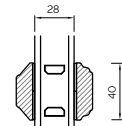

40MM BONDED BAR

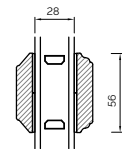

56MM BONDED BAR

EXTERNAL GLAZED 92MM FRAME SECTIONS

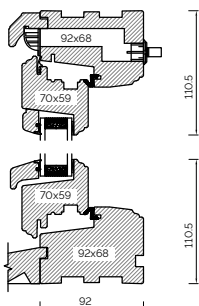

HEAD AND SOLE

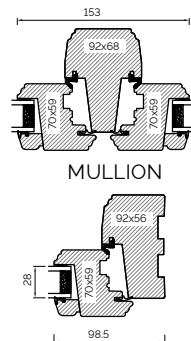

MULLION

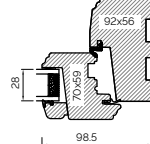

JAMB

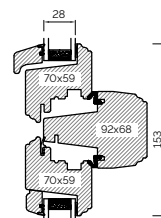

TRANSOM

INTERNAL GLAZED 68MM FRAME SECTIONS

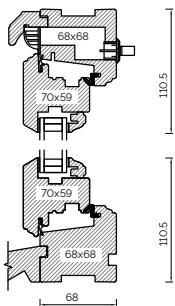

HEAD AND SOLE

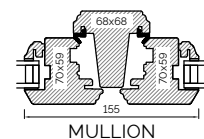

MULLION

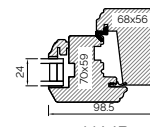

JAMB

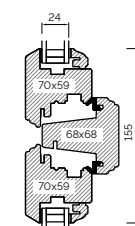

TRANSOM

BONDED BARS

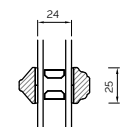

25MM BONDED BAR

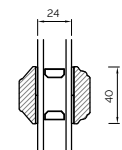

40MM BONDED BAR

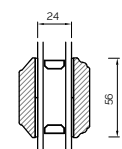

56MM BONDED BAR

INTERNAL GLAZED 92MM FRAME SECTIONS

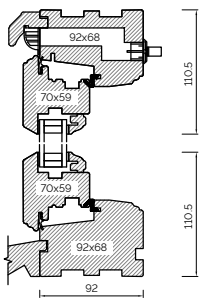

HEAD AND SOLE

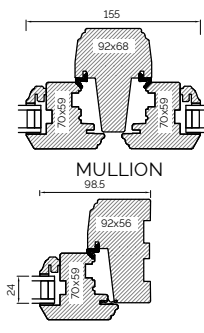

MULLION

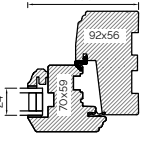

JAMB

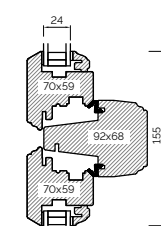

TRANSOM

The A-series Collection, Flush Casement 68mm & 92mm Frame

EXTERNAL GLAZED 68MM FRAME SECTIONS

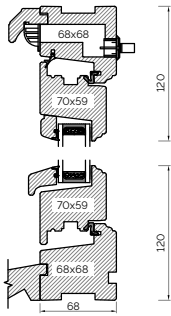

HEAD AND SOLE

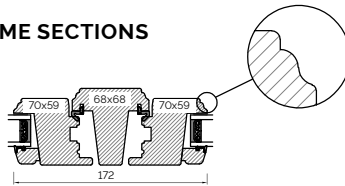

MULLION

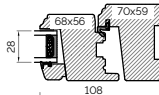

JAMB

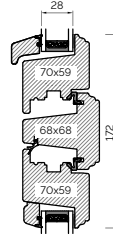

TRANSOM

BONDED BARS

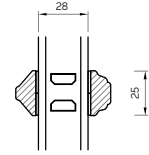

25MM BONDED BAR

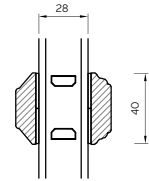

40MM BONDED BAR

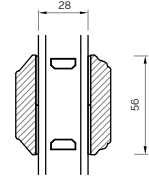

56MM BONDED BAR

EXTERNAL GLAZED 92MM FRAME SECTIONS

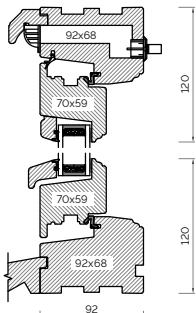

HEAD AND SOLE

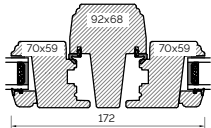

MULLION

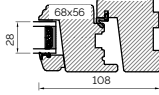

JAMB

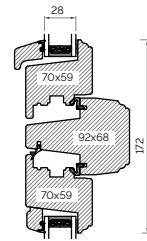

TRANSOM

INTERNAL GLAZED 68MM FRAME SECTIONS

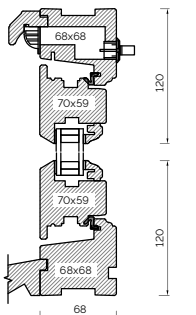

HEAD AND SOLE

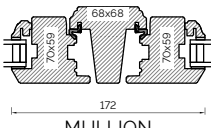

MULLION

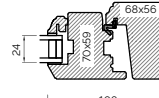

JAMB

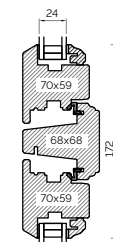

TRANSOM

BONDED BARS

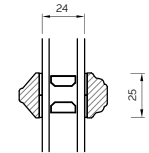

25MM BONDED BAR

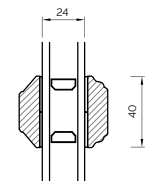

40MM BONDED BAR

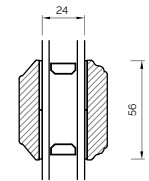

56MM BONDED BAR

INTERNAL GLAZED 92MM FRAME SECTIONS

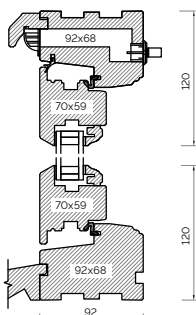

HEAD AND SOLE

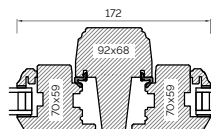

MULLION

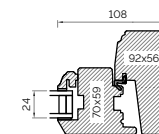

JAMB

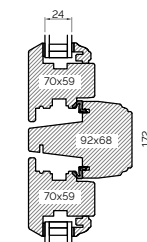

TRANSOM

The A-series Collection, French And Single Doors

92MM FRENCH DOOR OPEN OUT

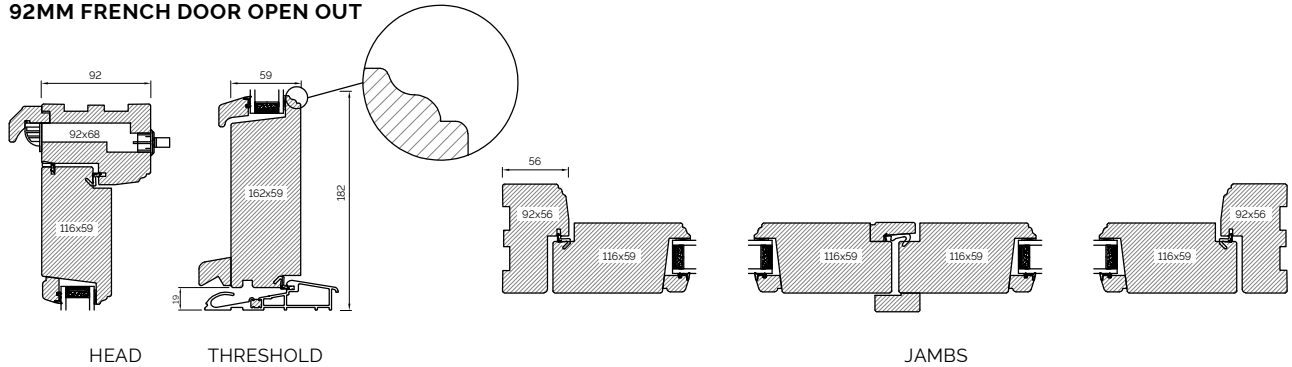

92MM FRENCH DOOR OPEN IN

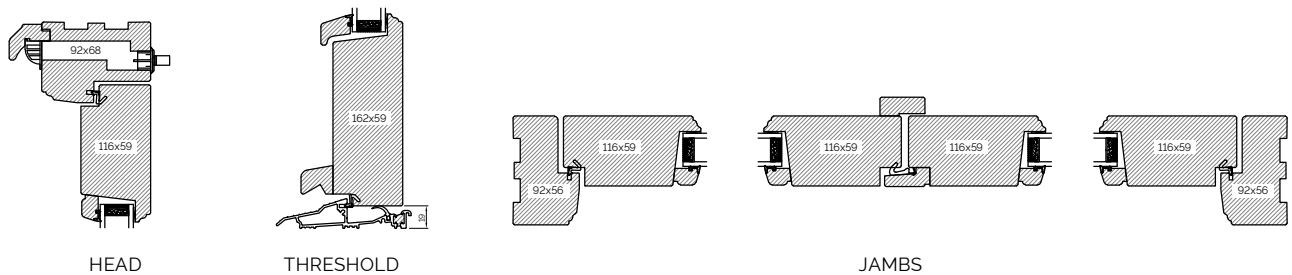

92MM SINGLE DOOR OPEN OUT

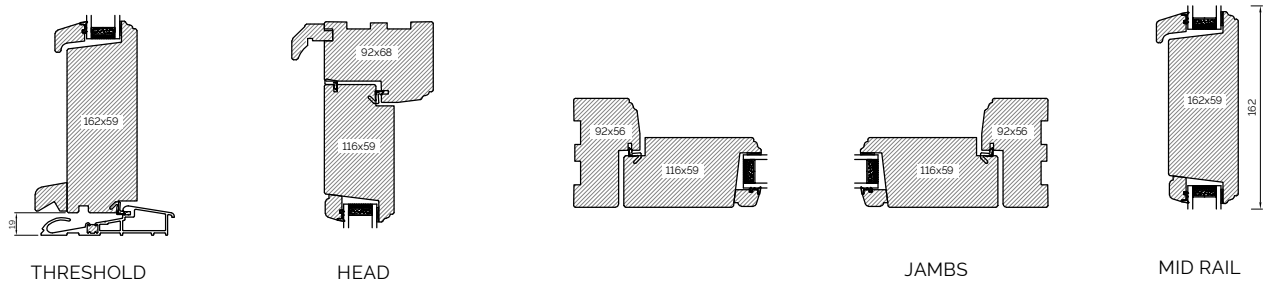

92MM SINGLE DOOR OPEN IN

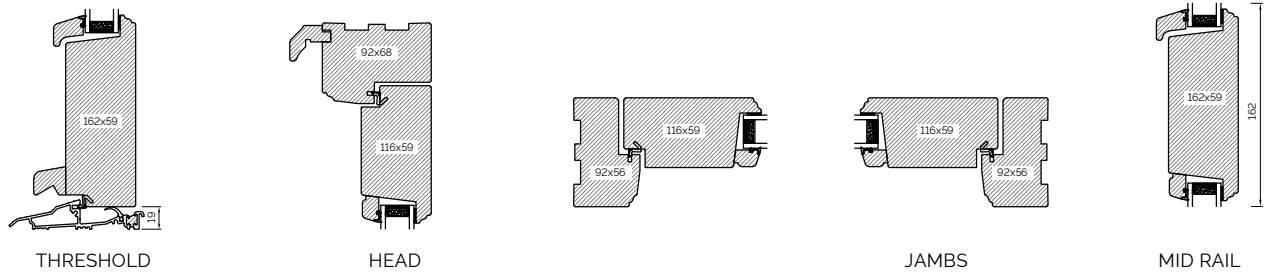

BONDED BARS

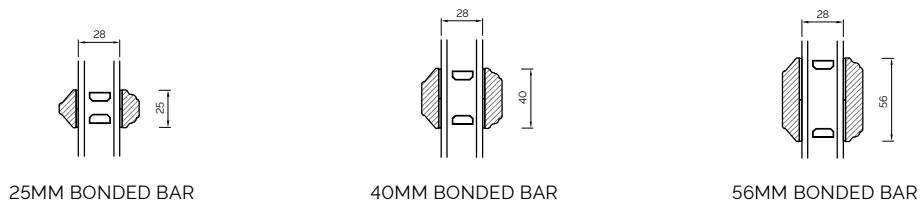

System 2000

SYSTEM 2000 SECTIONS

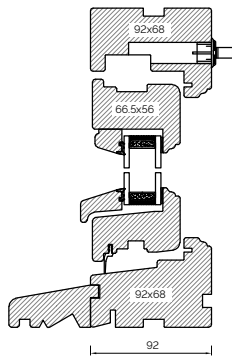

HEAD AND SOLE

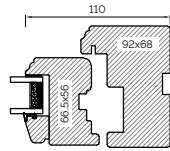

JAMB

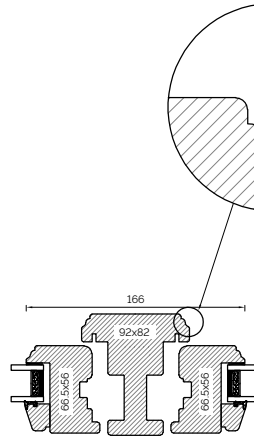

MULLION

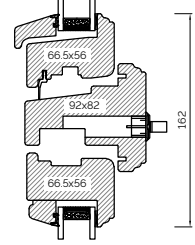

TRANSOM

CILL EXTENSIONS

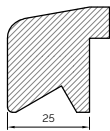

25MM CILL EXTENSION

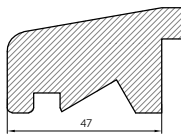

47MM CILL EXTENSION

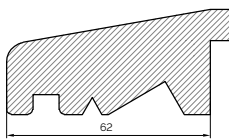

62MM CILL EXTENSION

BONDED BARS

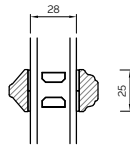

25MM BONDED BAR

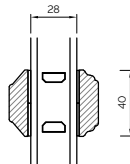

40MM BONDED BAR

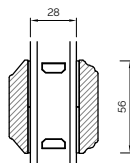

56MM BONDED BAR

BOTTOM BEADS

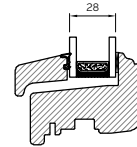

WOOD BOTTOM BEAD

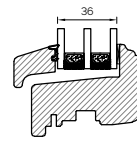

WOOD BOTTOM BEAD (TRIPLE GLAZED)

COUPLING

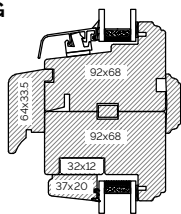

HORIZONTAL COUPLING

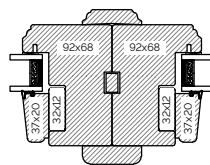

VERTICAL COUPLING

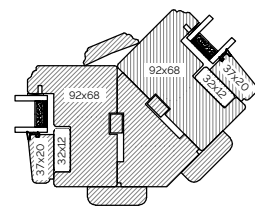

BAY COUPLING

The 1811 Sliding Sash Collection, Cords & Weights

95MM BOX INTERNAL GLAZED

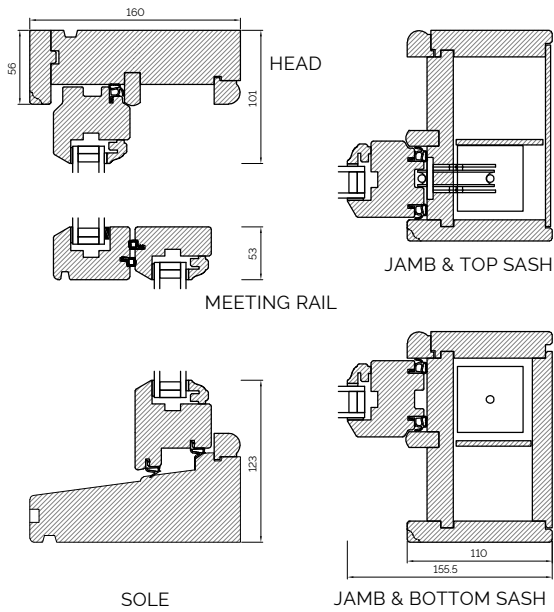

80MM BOX INTERNAL GLAZED

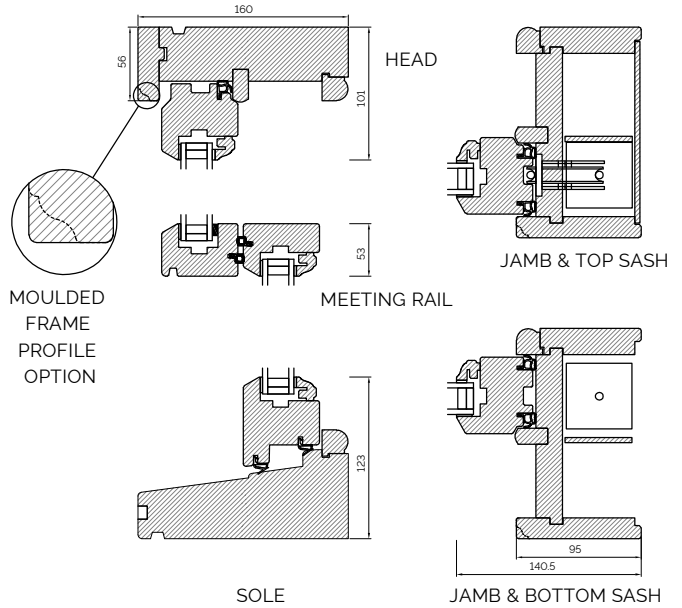

95MM BOX EXTERNAL GLAZED

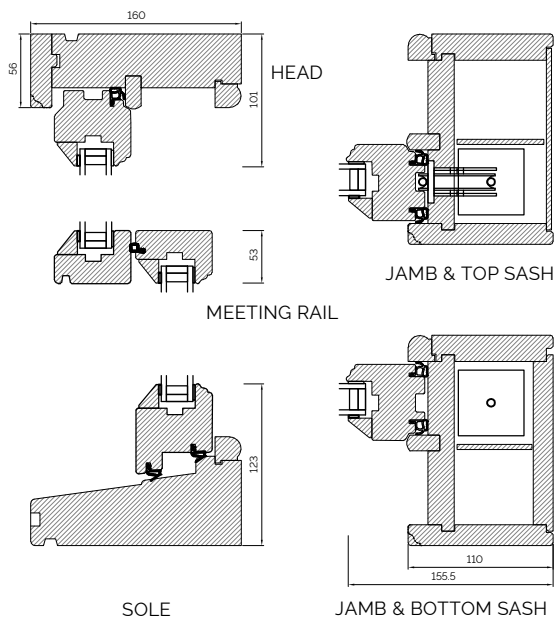

80MM BOX EXTERNAL GLAZED

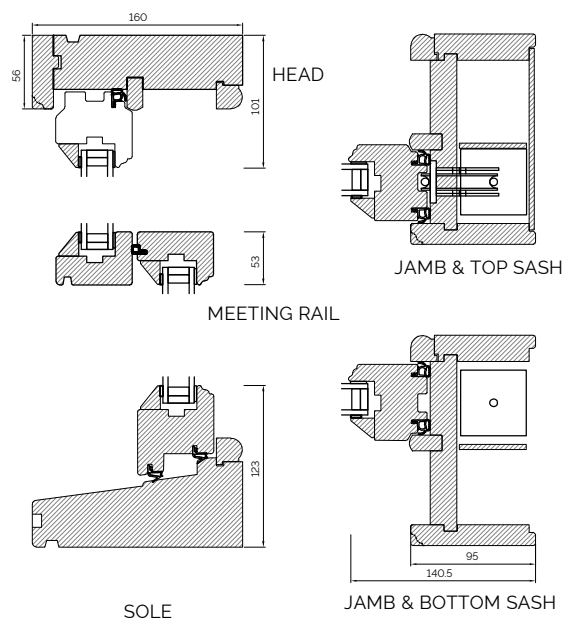

OVOLO BONDED BARS

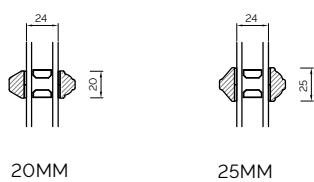

LAMBS TONGUE BONDED BARS

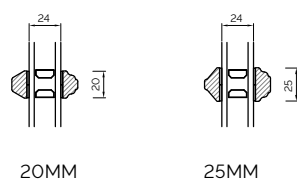

The 1811 Sliding Sash Collection, Spiral Balance

160MM SPIRAL BALANCE INTERNAL GLAZED

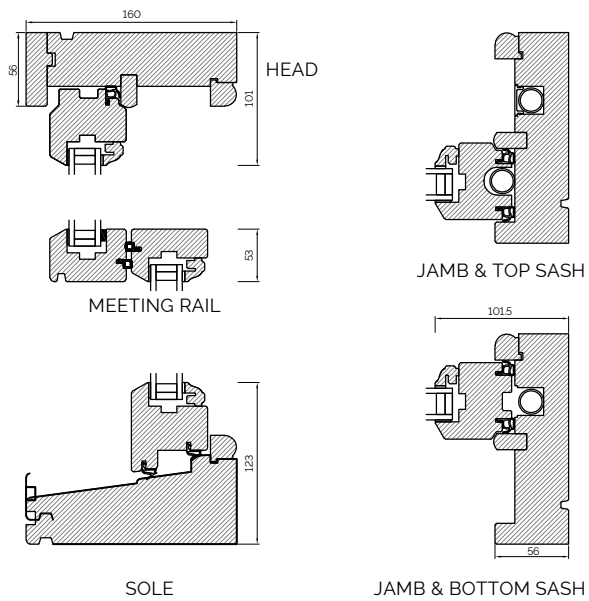

160MM SPIRAL BALANCE/MOULDED FRAME PROFILE INTERNAL GLAZED

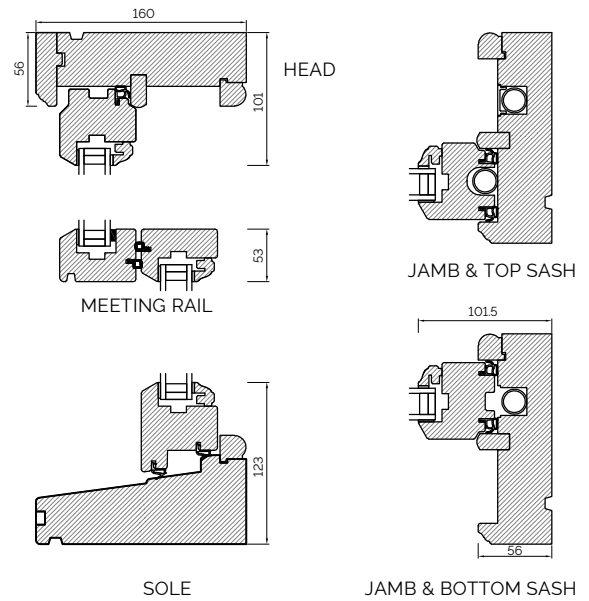

160MM SPIRAL BALANCE EXTERNAL GLAZED

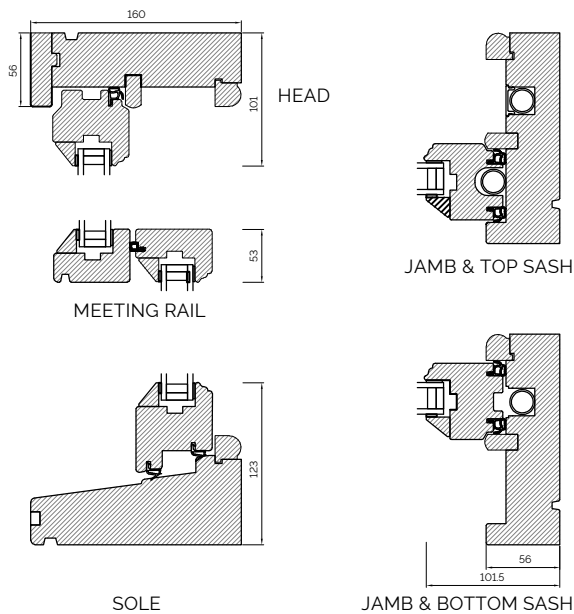

160MM SPIRAL BALANCE/MOULDED FRAME PROFILE EXTERNAL GLAZED

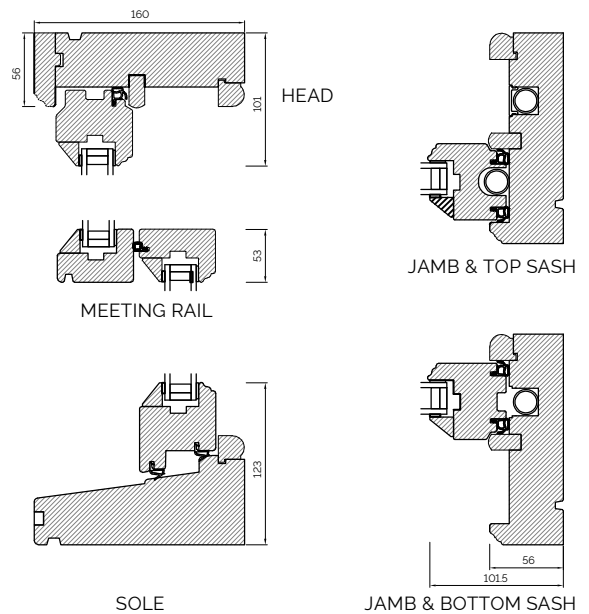

OVOLO BONDED BARS

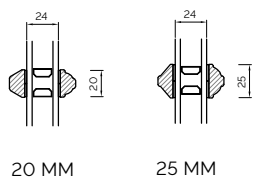

LAMBS TONGUE BONDED BARS

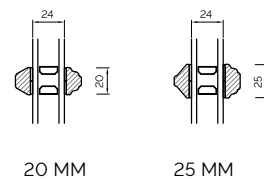

The Scotdoor Collection

SCOTDOOR THRESHOLD DETAILS

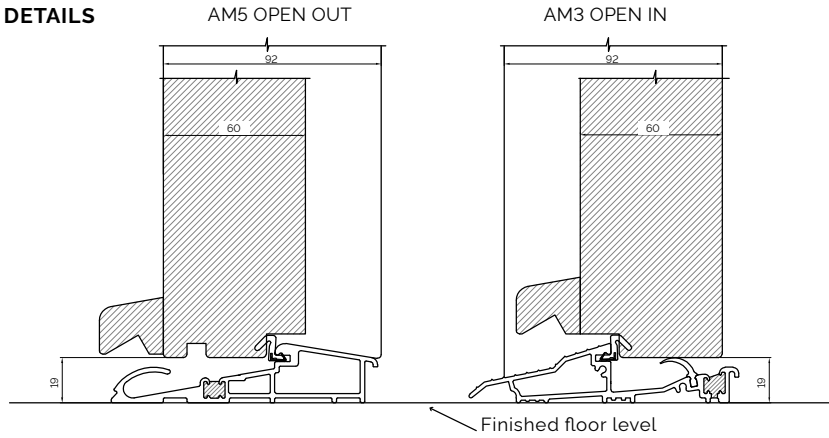

SCOTDOOR SECTIONS

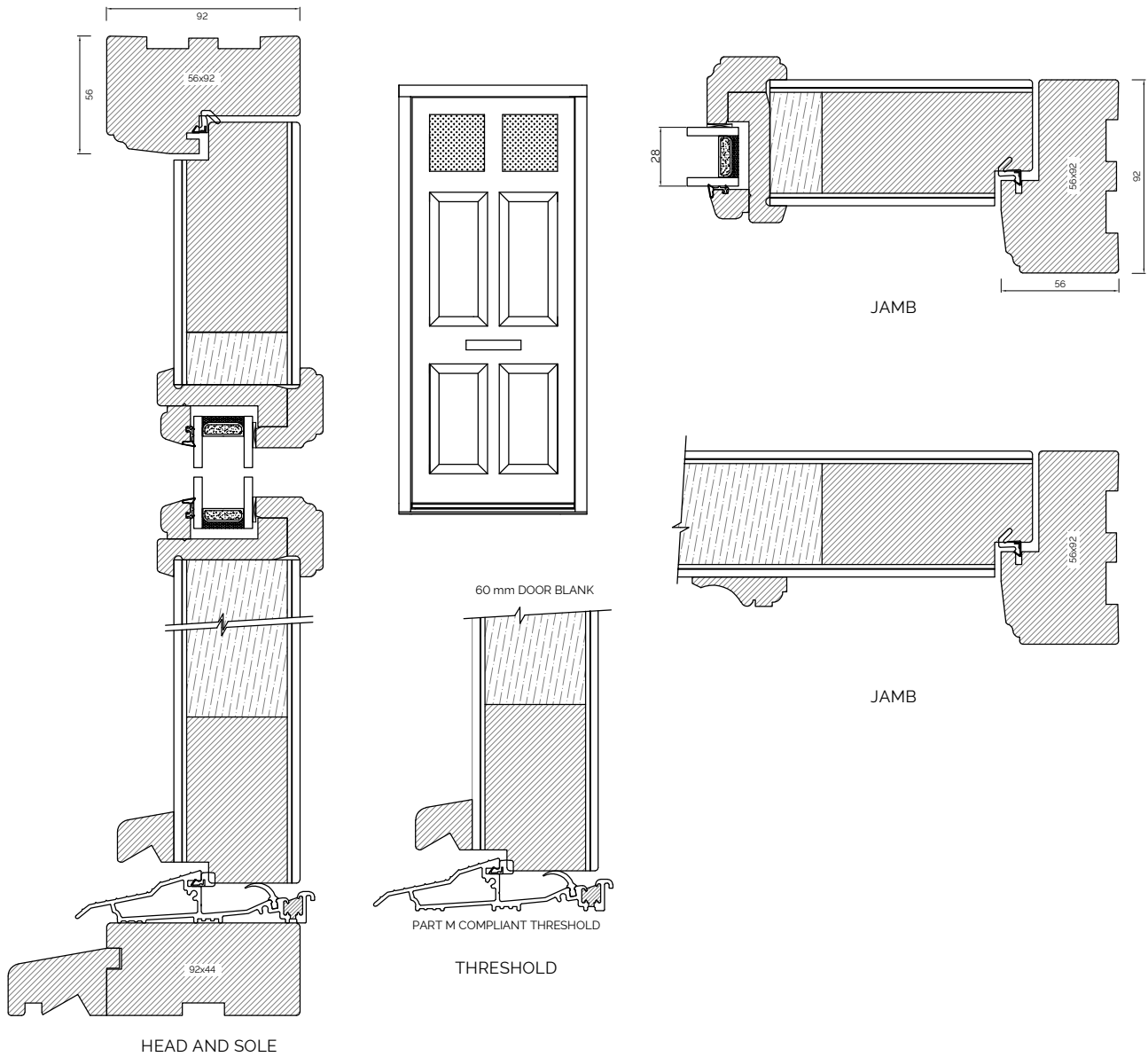

Alu Clad Timber Windows

OUTWARD SIDE HUNG WINDOW

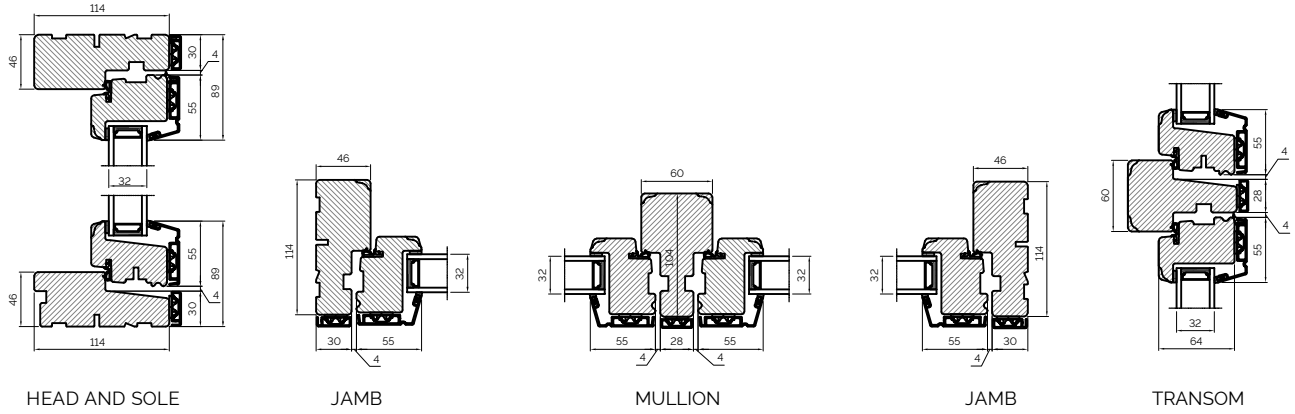

FIXED FRAME WINDOW

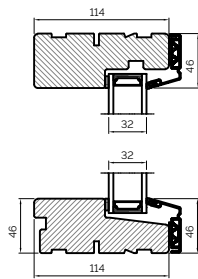

HEAD AND SOLE

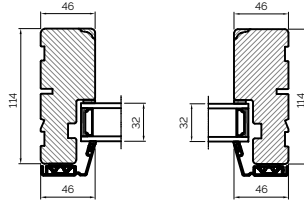

JAMB

BONDED BARS

SOFTLINE

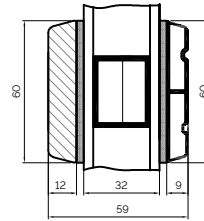

CLASSIC

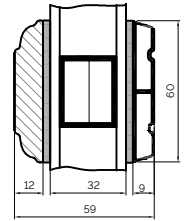

60MM BONDED BARS

TILT & TURN WINDOW

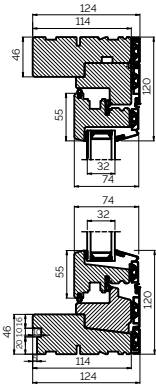

HEAD AND SOLE

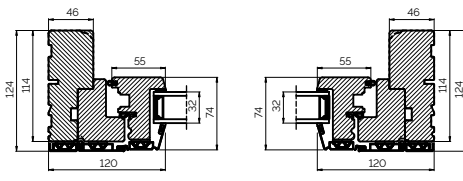

JAMB

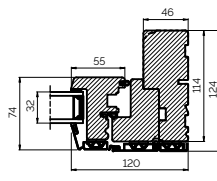

JAMB

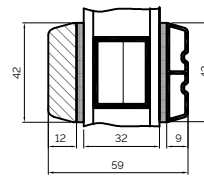

42MM BONDED BARS

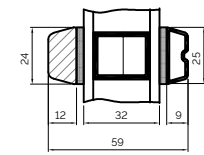
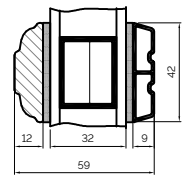

25MM BONDED BARS

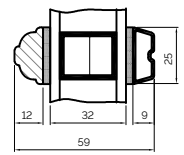

CORNER POSTS

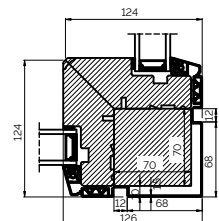
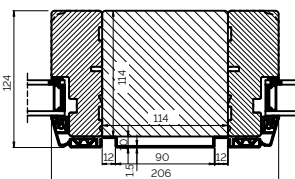
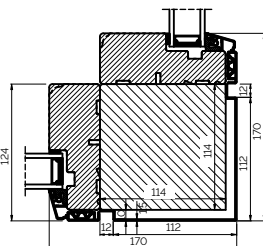
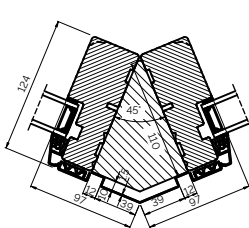

Alu Clad Timber Doors

DOUBLE DOOR OPEN OUT

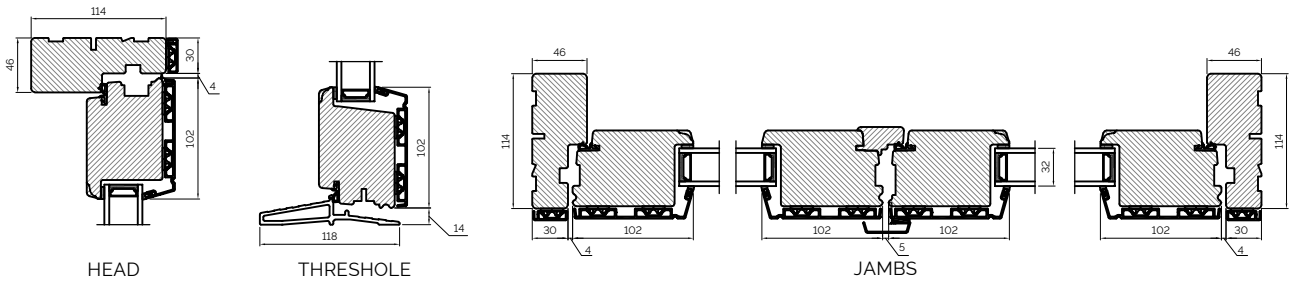

DOUBLE DOOR OPEN IN

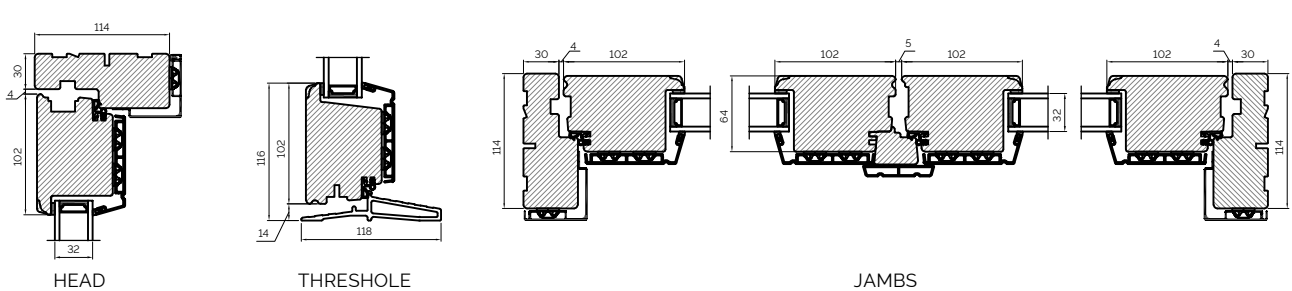

SINGLE DOOR OPEN IN

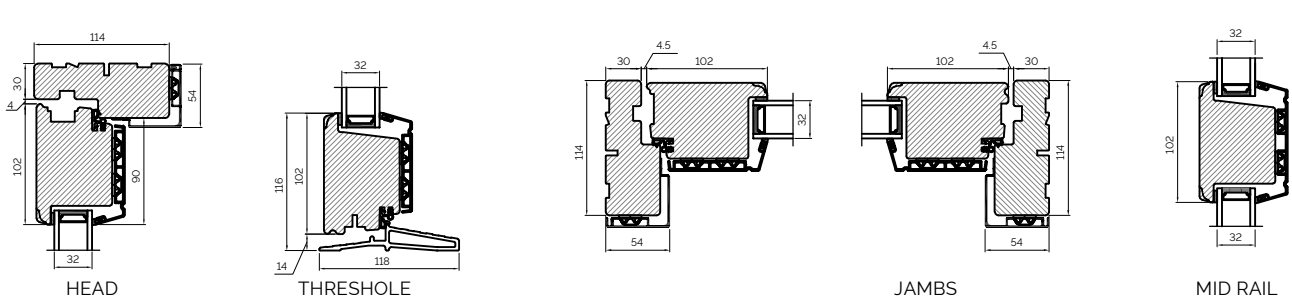

SLIDING DOOR

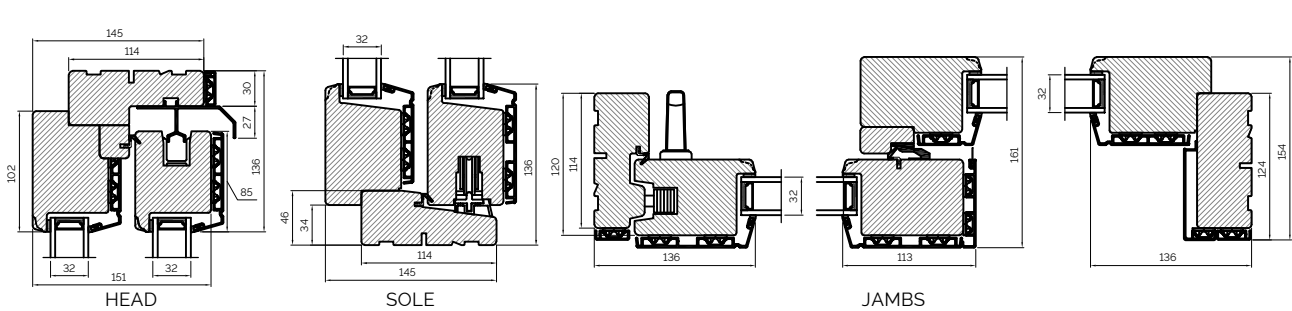

BI-FOLDING DOOR

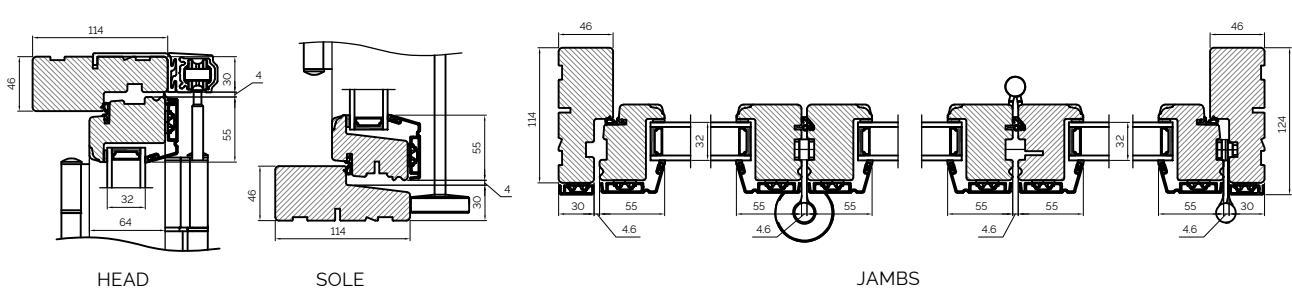

ALLAN EST.
1811 **BROS.**
Craftsmen of Bespoke Timber Windows & Doors

Allan House, Ord Road, Berwick-upon-Tweed, Northumberland, TD15 2XU
Tel: +44 (0)1289 334600 | Fax: +44 (0)1289 334601 | Email: enquiries@allanbrothers.co.uk
www.allanbrothers.co.uk

01.23 | Allan Bros reserve the right to change the products and product ranges without notice.